

10445765 - LED-DECKENLEUCHTE

Demontage und Entsorgung

! **Warnung:** Die folgenden Arbeitsschritte dürfen nur von Elektrofachkräften durchgeführt werden.

I.

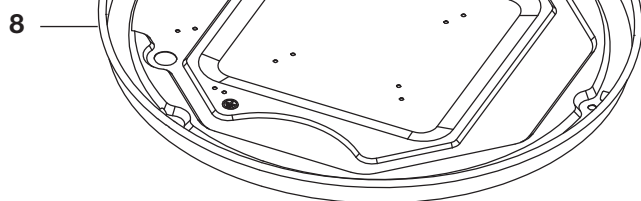
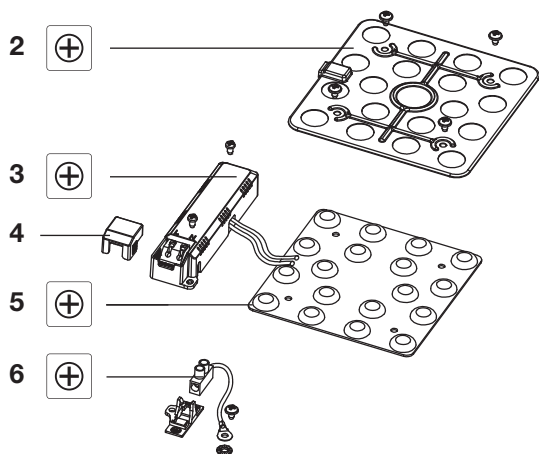
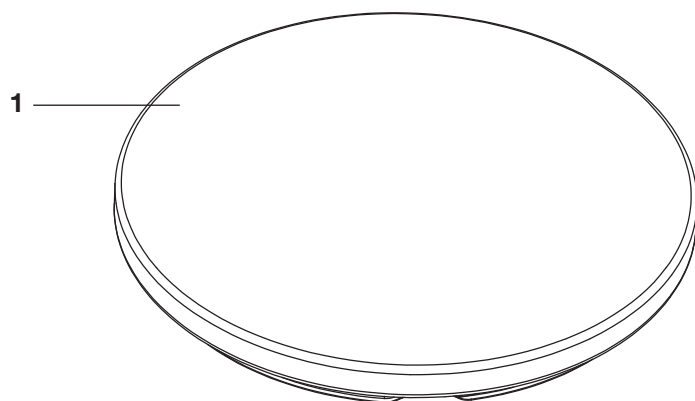

II.

! **Vorsicht:** Vor jeglichen Arbeiten am Gerät die Leuchte vom Netz trennen.

Demontage

1. Die Opalabdeckung **1** von der Grundplatte **8** abschrauben.
2. Die Schrauben der LED-Platine **5** lösen.
3. Die Schrauben des LED-Treibers **3** lösen.
4. Den LED-Treiber **3**, die LED-Platinenabdeckung **2** und die LED-Platine **5** entfernen.
5. Die Schraube des Schutzerde-Anschlusses **6** lösen und diesen entfernen.

III.

Die einzelnen Bauteile entsprechend geltenden Vorschriften entsorgen!

Bauteil

- | | |
|---|----------------------------|
| 1 | Opalabdeckung |
| 2 | LED-Platinenabdeckung |
| 3 | LED-Treiber |
| 4 | Abdeckung Anschlussklemmen |
| 5 | LED-Platine |
| 6 | Anschluss Schutzerde |
| 7 | Dichtung |
| 8 | Grundplatte |

IV.

Benötigtes Werkzeug

- | | |
|---|-----------------------------|
|  | Kreuzschlitzschraubendreher |
|---|-----------------------------|

HORNBACH Baumarkt AG
Hornbachstraße 11
76879 Bornheim / Deutschland

www.hornbach.com

10445765 - LUMINAIRE PLAFONNIER LED

Démontage et élimination

⚠ Avertissement : Les opérations suivantes doivent être effectuées par un électricien qualifié.

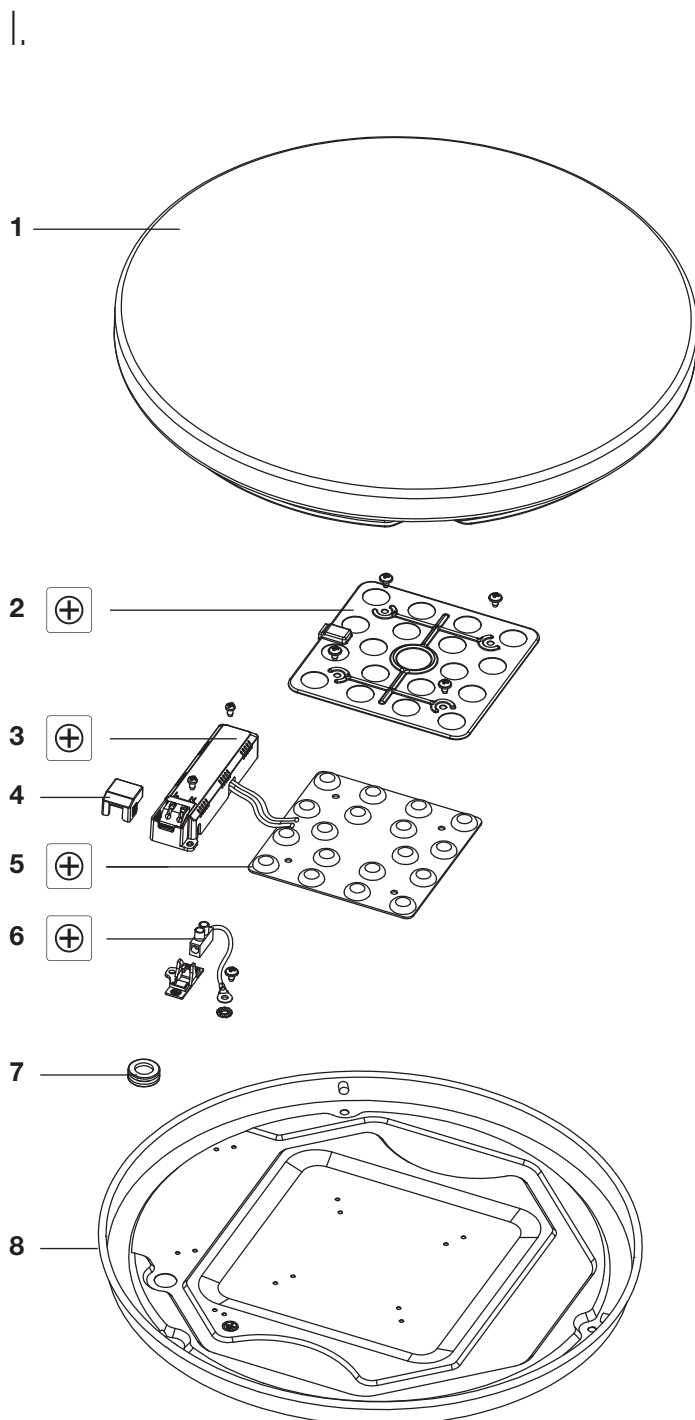

II.

⚠ Attention : Débrancher de l'alimentation secteur avant toute opération sur l'appareil.

Démontage

1. Dévisser l'abat-jour en verre opale **1** du boîtier **8**.
2. Desserrer les vis de la plaque LED **5** ⊕.
3. Desserrer les vis de la commande de LED **3** ⊕.
4. Enlever la commande de LED **3** ⊕, le couvercle de la plaque **2** ⊕ et la plaque LED **5** ⊕.
5. Desserrer la vis du raccordement du conducteur de protection **6** ⊕ et l'enlever.

III.

Jeter les composants individuels conformément aux réglementations en vigueur !

Composants

- | | |
|---|--|
| 1 | Abat-jour en verre opale |
| 2 | Couvercle de la plaque LED |
| 3 | Commande de LED |
| 4 | Couvercle de borne |
| 5 | Plaque LED |
| 6 | Raccordement du conducteur de protection |
| 7 | Joint d'étanchéité |
| 8 | Boîtier |

IV.

Outils nécessaires

- | | |
|---|----------------------|
| ⊕ | Tournevis cruciforme |
|---|----------------------|

HORNBACH Baumarkt AG
Hornbachstraße 11
76879 Bornheim / Deutschland

www.hornbach.com

10445765 - LAMPADA A LED DA SOFFITTO

Smontaggio e smaltimento

 **Avvertenza: Il seguente lavoro deve essere eseguito da un elettricista qualificato.**

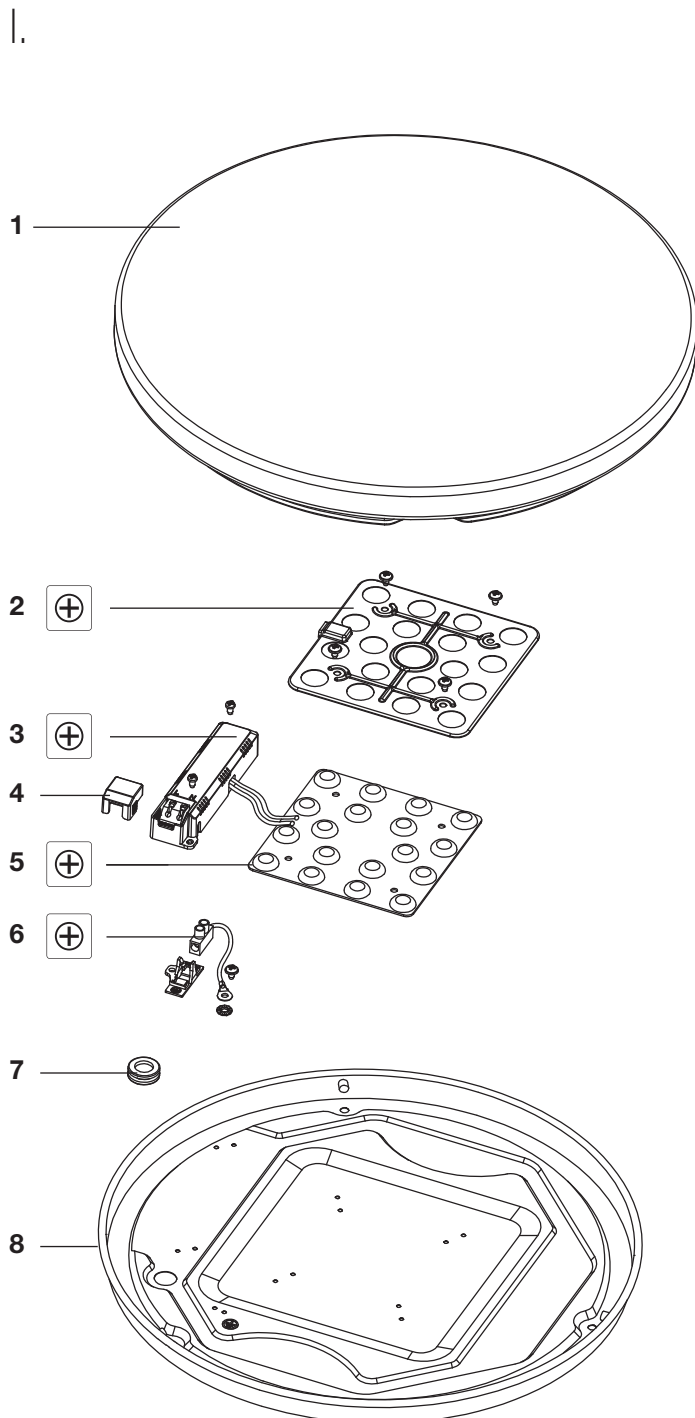

II.

 **Attenzione: Scollegare dalla rete elettrica prima di qualsiasi operazione sul dispositivo.**

Smontaggio

1. Svitare il paralume bianco **1** dall'alloggiamento **8**.
2. Allentare le viti della scheda LED **5** ⊕.
3. Allentare le viti del driver LED **3** ⊕.
4. Rimuovere il driver LED **3** ⊕, il coperchio della scheda **2** ⊕, e la scheda LED **5** ⊕.
5. Allentare la vite del collegamento della messa a terra di protezione **6** ⊕ e rimuoverlo.

III.

Smaltire i singoli componenti in conformità alle normative vigenti!

Componente

- | | |
|---|--|
| 1 | Paralume bianco |
| 2 | Coperchio scheda LED |
| 3 | Driver LED |
| 4 | Copertura terminale |
| 5 | Scheda LED |
| 6 | Collegamento della messa a terra di protezione |
| 7 | Guarnizione |
| 8 | Alloggiamento |

IV.

Utensili necessari

- | | |
|---|--------------------|
|  | Cacciavite a croce |
|---|--------------------|

HORNBACH Baumarkt AG
Hornbachstraße 11
76879 Bornheim / Deutschland

www.hornbach.com

10445765 - LED-PLAFONDARMATUUR

Demontage en afvoeren

! **Waarschuwing:** De volgende werkzaamheden moeten door een gekwalificeerde elektricien worden uitgevoerd.

I.

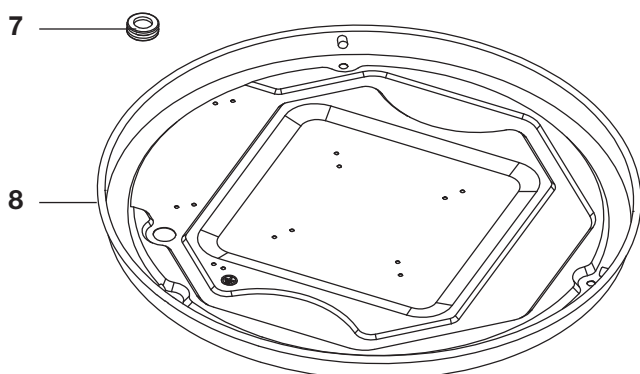
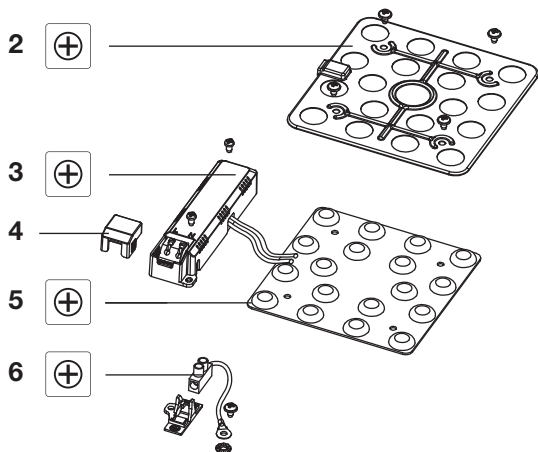
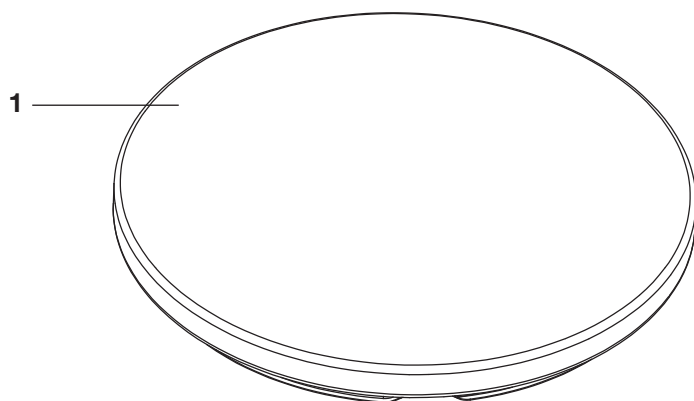

II.

! **Voorzichtig:** Haal de stekker uit het stopcontact voordat u werkzaamheden aan het apparaat uitvoert.

Demontage

1. Schroef de melkwitte lampenkap **1** los van de behuizing **8**.
2. Draai de schroeven van de LED-kaart **5** los.
3. Draai de schroeven van de LED-driver **3** los.
4. Verwijder de LED-driver **3**, de kaartafdekking **2**, en de LED-kaart **5**.
5. Draai de schroef van de aardaansluiting **6** los en verwijder deze.

III.

Voer de afzonderlijke onderdelen volgens de geldende voorschriften af!

Onderdeel

- | | |
|---|---------------------|
| 1 | Melkwitte lampenkap |
| 2 | LED-kaartafdekking |
| 3 | LED-driver |
| 4 | Klemmenafdekking |
| 5 | LED-kaart |
| 6 | Aardaansluiting |
| 7 | Afdichting |
| 8 | Behuizing |

IV.

Benodigd gereedschap

- | | |
|--|--------------------------|
| | Kruiskopschroevendraaier |
|--|--------------------------|

HORNBACH Baumarkt AG
Hornbachstraße 11
76879 Bornheim/Duitsland

www.hornbach.com

10445765 - LED-TAKLAMPA

Demontering och kassering

 **Varning: Följande arbete ska utföras av en behörig elektriker.**



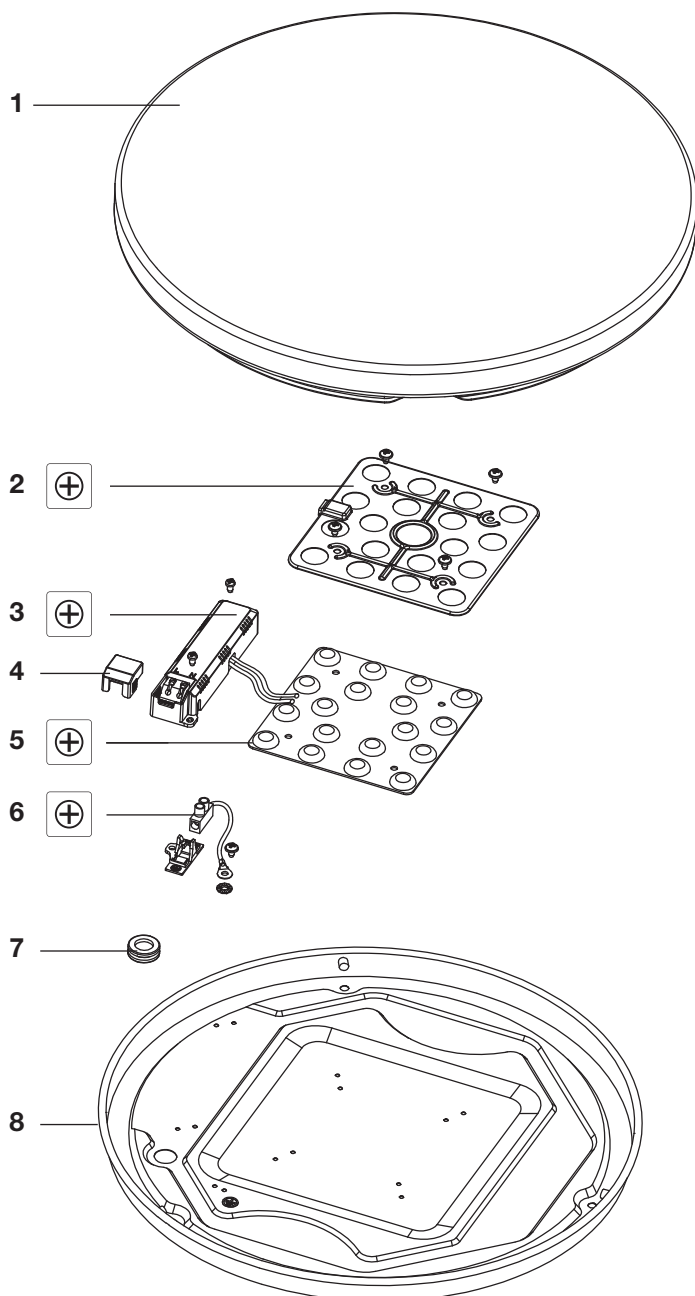



I.



II.

 **Observera! Koppla bort strömförsörjningen innan något arbete utförs på enheten.**

Demontering

1. Skruva loss den lampskärmen i opalglas **1** från höljet **8**.
2. Lossa på skruvarna till LED-remsan **5** .
3. Lossa på skruvarna till LED-drivenheten **3** .
4. Ta bort LED -drivenheten **3** , remsans överdrag **2** , och LED-remsan **5** .
5. Lossa på skruven till skyddsjordanslutningen **6**  och ta bort den.

III.

Kassera de enskilda komponenterna enligt gällande föreskrifter!

Komponent

- | | |
|---|-------------------------|
| 1 | Lampskärm i opalglas |
| 2 | Överdrag till LED-remsa |
| 3 | LED-drivenhet |
| 4 | Terminalskydd |
| 5 | LED-remsa |
| 6 | Skyddsjordanslutning |
| 7 | Tätning |
| 8 | Hölje |

IV.

Nödvändiga verktyg

- | | |
|---|-------------------|
|  | Stjärnskruvmejsel |
|---|-------------------|

HORNBACH Baumarkt AG
Hornbachstraße 11
76879 Bornheim / Deutschland

www.hornbach.com

10445765 - LED STROPNÍ SVÍTIDLO

Demontáž a likvidace

! Výstraha: Následující práce smí provádět pouze kvalifikovaní elektrikáři.



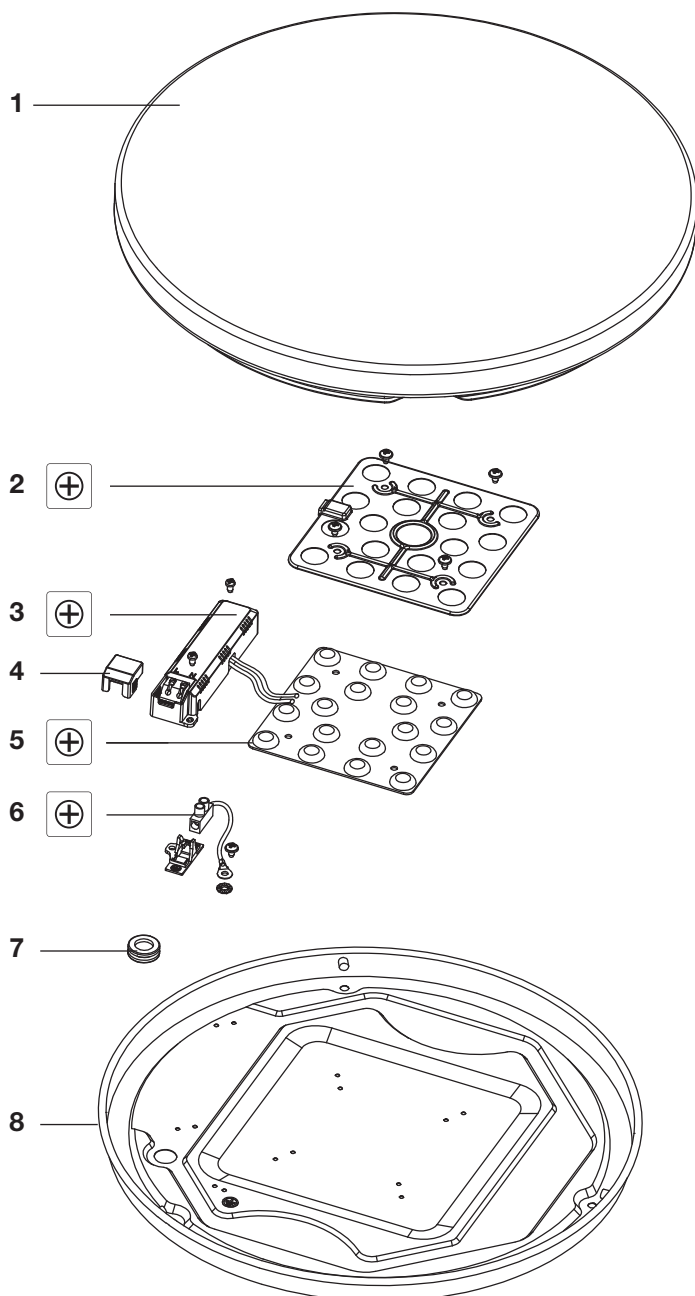



I.



II.

! Upozornění: Před jakýmkoli úkony na zařízení jej odpojte od elektrické sítě.

Demontáž

1. Odšroubujte stínidlo z mléčného skla **1** od krytu **8**.
2. Uvolněte šrouby LED desky **5** .
3. Uvolněte šrouby LED ovladače **3** .
4. Vyjměte LED ovladač **3** , kryt desky **2**  a LED desku **5** .
5. Uvolněte šroub připojení ochranného uzemnění **6**  a vyjměte jej.

III.

Jednotlivé součásti likvidujte v souladu s platnými právními předpisy!

Komponenta

- | | |
|---|-------------------------------|
| 1 | Stínidlo z mléčného skla |
| 2 | Kryt LED desky |
| 3 | LED ovladač |
| 4 | Krytka svorky |
| 5 | LED deska |
| 6 | Připojení ochranného uzemnění |
| 7 | Těsnění |
| 8 | Kryt |

IV.

Potřebné nářadí

- | | |
|---|-------------------|
|  | Křížový šroubovák |
|---|-------------------|

HORNBACH Baumarkt AG
Hornbachstraße 11
76879 Bornheim / Německo

www.hornbach.com

10445765 - STROPNÉ LED SVIETIDLO

Demontáž a likvidácia

! Výstraha: Nasledujúce elektrické práce a opravy musí vykonávať kvalifikovaný elektrikár.

I.

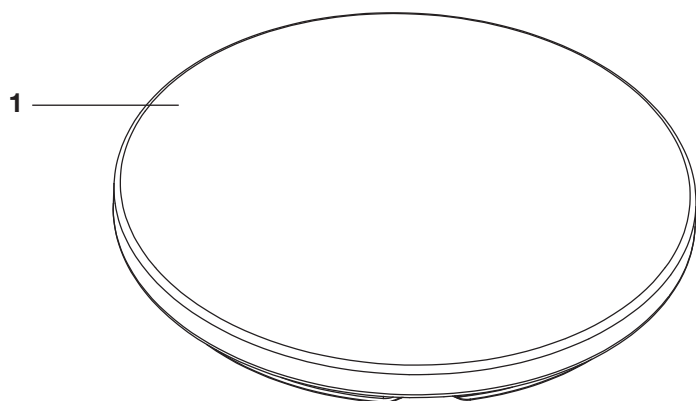

2

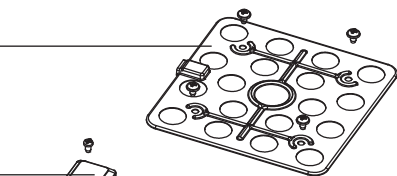

3

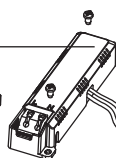

4



5

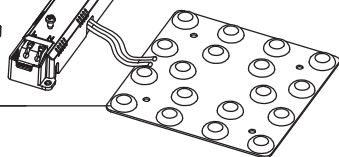

6



7



8

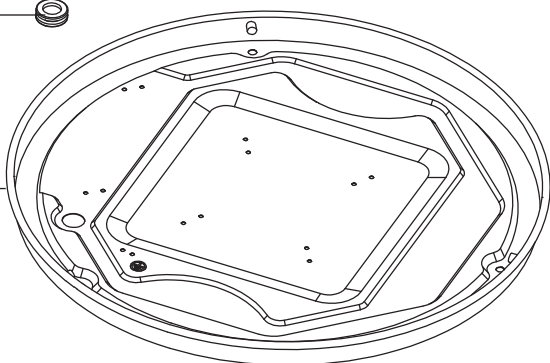

II.

! Upozornenie: Zariadenie odpojte od hlavného prívodu elektrickej siete pred vykonávaním akýchkoľvek prác na ňom.

Demontáž

1. Mliečne tienidlo lampy **1** odskrutkujte z telesa **8**.
2. Uvoľnite skrutky na doske LED svetelných zdrojov **5** .
3. Uvoľnite skrutky na doske s LED a náhonu **3** .
4. Vyberte štartér LED svetelných zdrojov **3** , kryt dosky **2** a dosku s LED svetelnými zdrojmi **5** .
5. Uvoľnite skrutku na svorku ochranného uzemnenia **6** a vyberte ju.

III.

Jednotlivé súčasti zlikvidujte v súlade s platnými predpismi!

Súčasť

- | | |
|---|-------------------------------------|
| 1 | Mliečne tienidlo lampy |
| 2 | Kryt dosky s LED svetelnými zdrojmi |
| 3 | Štartér LED svetelných zdrojov |
| 4 | Kryt svorkovnice |
| 5 | Doska s LED svetelnými zdrojmi |
| 6 | Prípojka ochranného uzemnenia |
| 7 | Tesnenie |
| 8 | Teleso |

IV.

Požadované nástroje

- | | |
|--|--------------------|
| | Krížový skrutkovač |
|--|--------------------|

HORNBACH Baumarkt AG
Hornbachstraße 11
76879 Bornheim/Nemecko

www.hornbach.com

10445765 - PLAFONIERĂ CU LED

Demontarea și eliminarea

 **Avertisment:** Lucrarea următoare trebuie efectuată de un electrician calificat.



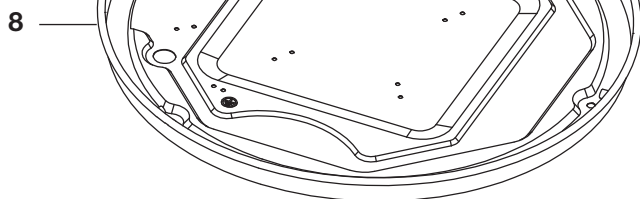
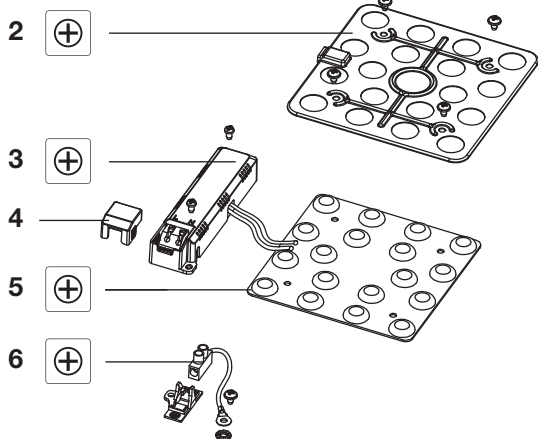
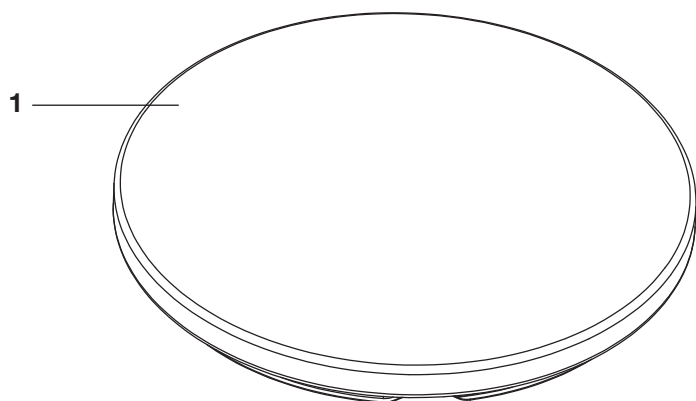



I.



II.

 **Atenție:** Înainte de a efectua orice operațiuni pe dispozitiv, deconectați-l de la sursa de alimentare.

Demontarea

1. Deșurubați abajurul alb **1** de pe carcasă **8**.
2. Slăbiți șuruburile plăcii LED **5** .
3. Slăbiți șuruburile unității LED **3** .
4. Îndepărtați unitatea LED **3** , capacul plăcii **2**  și placa LED **5** .
5. Slăbiți șurubul racordului de împământare **6**  și îndepărtați-l.

III.

Eliminați componentele individuale în conformitate cu reglementările în vigoare!

Componentă

1	Abajur alb
2	Capac placă LED
3	Unitate LED
4	Capac cutie de borne
5	Placă LED
6	Racord de împământare
7	Garnitură
8	Carcasă

IV.

Instrumente necesare

-  Șurubelniță în cruce

HORNBACH Baumarkt AG
Hornbachstraße 11
76879 Bornheim / Deutschland

www.hornbach.com

10445765 - LED CEILING LUMINAIRE

Dismounting and disposal



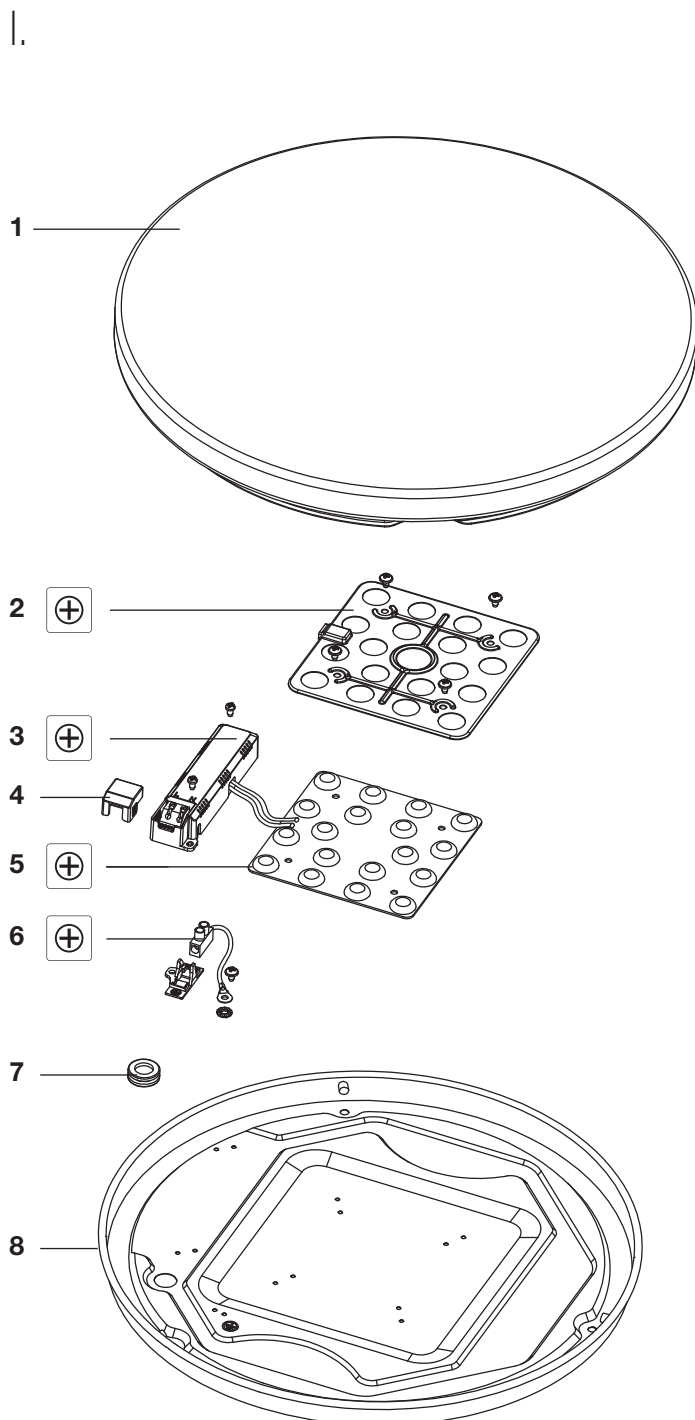



 **Warning:** The following work must be performed by a qualified electrician.



II.

 **Caution:** Disconnect from power mains prior to any operations on the device.

Dismounting

1. Unscrew the milky lamp shade **1** from the housing **8**.
2. Loosen the screws of the LED board **5** .
3. Loosen the screws of the LED driver **3** .
4. Remove the LED driver **3** , the board cover **2** , and the LED board **5** .
5. Loosen the screw of the protective earth connection **6**  and remove it.

III.

Dispose of the individual components according to the applicable regulations!

Component

1	Milky lamp shade
2	LED board cover
3	LED driver
4	Terminal cover
5	LED board
6	Protective earth connection
7	Sealing
8	Housing

IV.

Required tools

	Cross-tip screwdriver
---	-----------------------

HORNBACH Baumarkt AG
Hornbachstraße 11
76879 Bornheim / Deutschland

www.hornbach.com