

10599900

LED-AUSSENLEUCHE MIT BEWEGUNGSSENSOR

Demontage und Entsorgung

I.

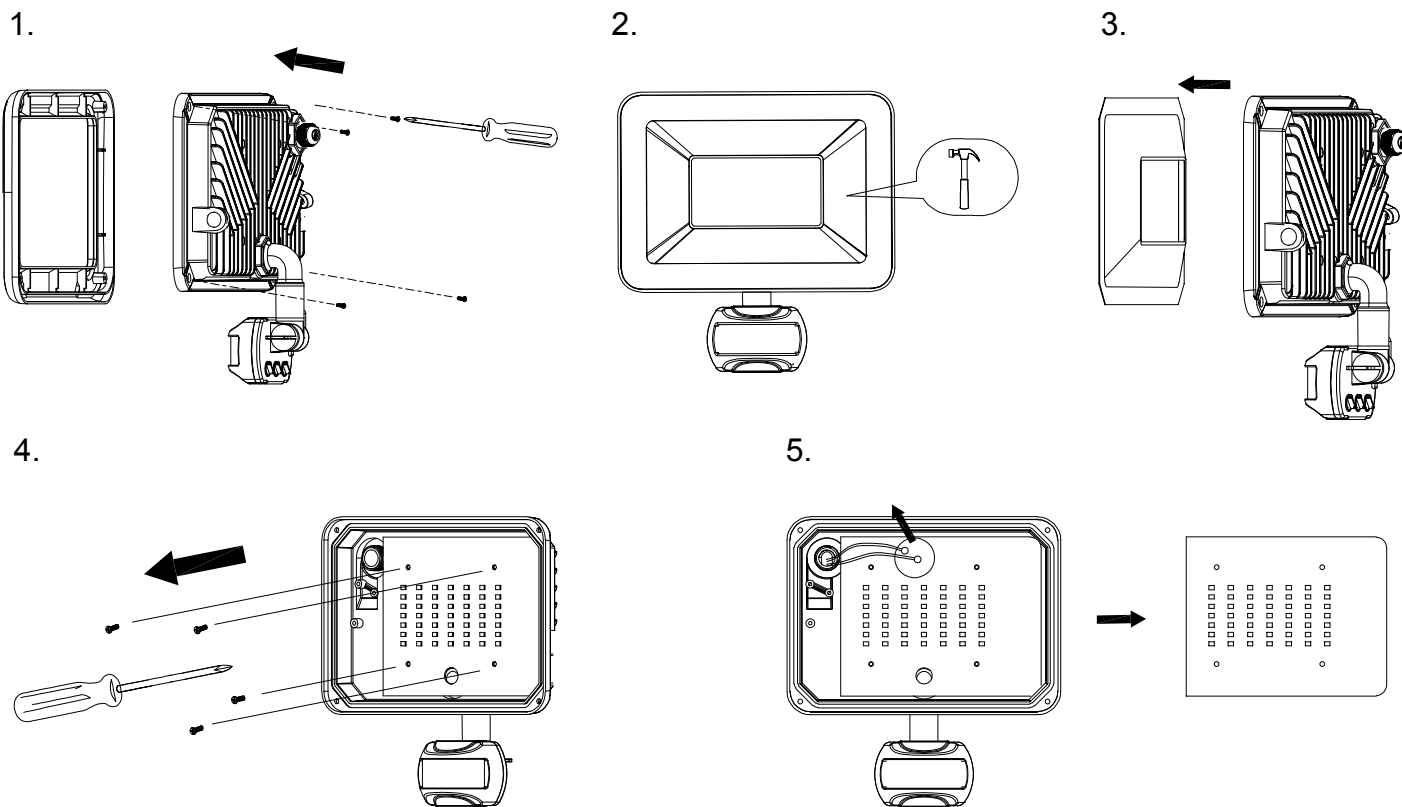

⚠️ Warnung: Die folgenden Arbeitsschritte dürfen nur von Elektrofachkräften durchgeführt werden.

II.



Benötigtes Werkzeug

 Kreuzschlitzschraubendreher

 Hammer

⚠️ Vorsicht: Vor jeglichen Arbeiten am Gerät die Leuchte vom Netz trennen.

Demontage

1. Den Rahmen abschrauben .
2. Das fest verklebte Schutzglas zerstören  und entfernen.
3. Den Metallschirm abnehmen.
4. Die Schrauben der integrierten Leuchteinheit mit Betriebsgerät lösen .
5. Das Kabel lösen und die integrierte LED-Platine mit Betriebsgerät entnehmen.

III.

Die einzelnen Bauteile entsprechend geltenden Vorschriften entsorgen!

HORNBACH Baumarkt AG
Hornbachstraße 11
76879 Bornheim / Deutschland

www.hornbach.com

10599900

LAMPE EXTÉRIURE À LED AVEC DÉTECTEUR PIR

Démontage et mise au rebut

I.

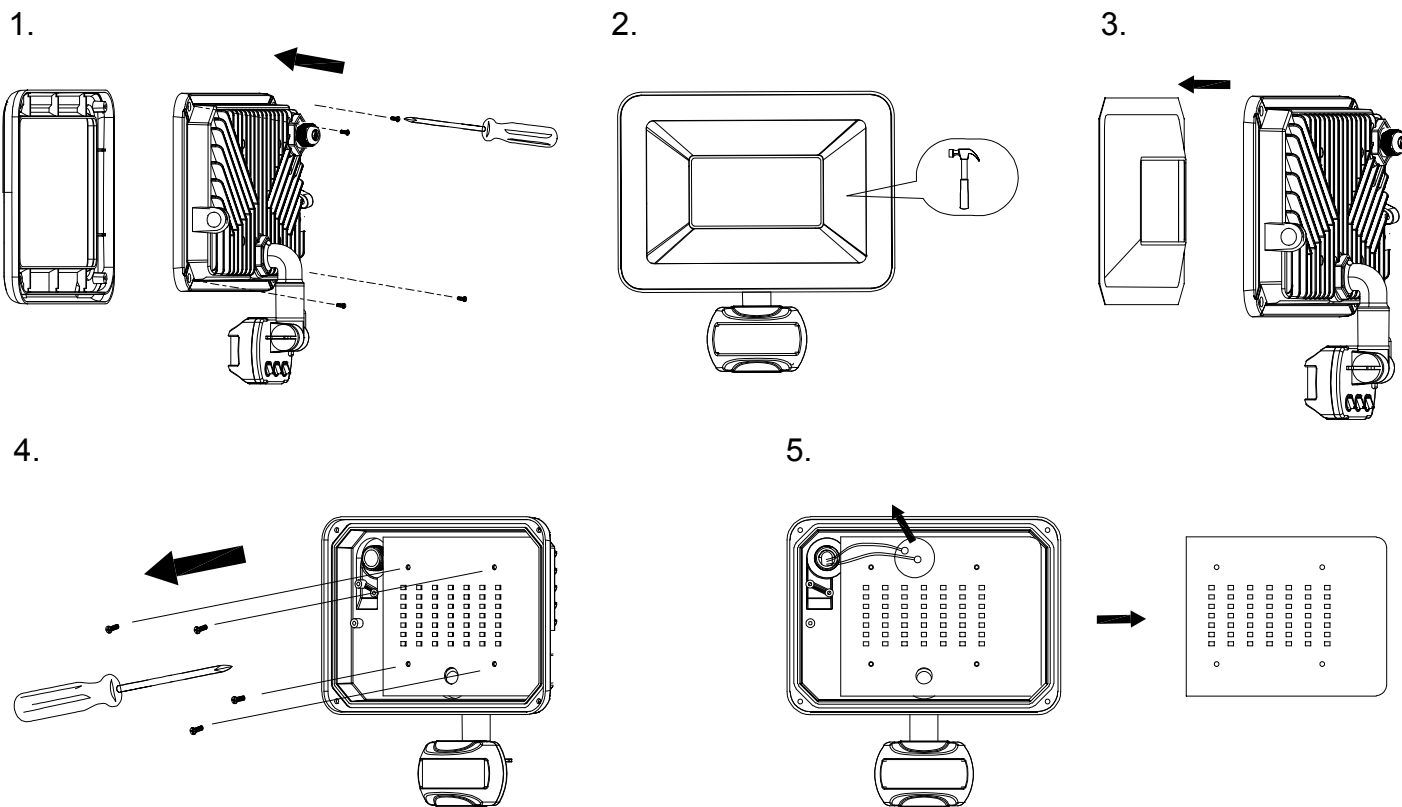

⚠ Avertissement : Les opérations suivantes doivent être effectuées par un électricien qualifié.

II.



Outils nécessaires

 Tournevis cruciforme

 Marteau

⚠ Attention : Débranchez du secteur avant d'intervenir sur l'appareil.

Démontage

1. Dévissez le châssis .
2. Brisez la verre de protection  et retirez-le.
3. Retirez la plaque métallique.
4. Dévissez les vis de l'unité à LED intégrée avec un tournevis .
5. Desserrez le câble et retirez la carte à LED intégrée avec un tournevis.

III.

Mettez les différents composants au rebut selon les réglementations applicables !

HORNBACH Baumarkt AG
Hornbachstr. 11
76879 Bornheim / Allemagne

www.hornbach.com

10599900

LAMPADA DA ESTERNO A LED CON SENSORE PIR

Smontaggio e smaltimento

I.

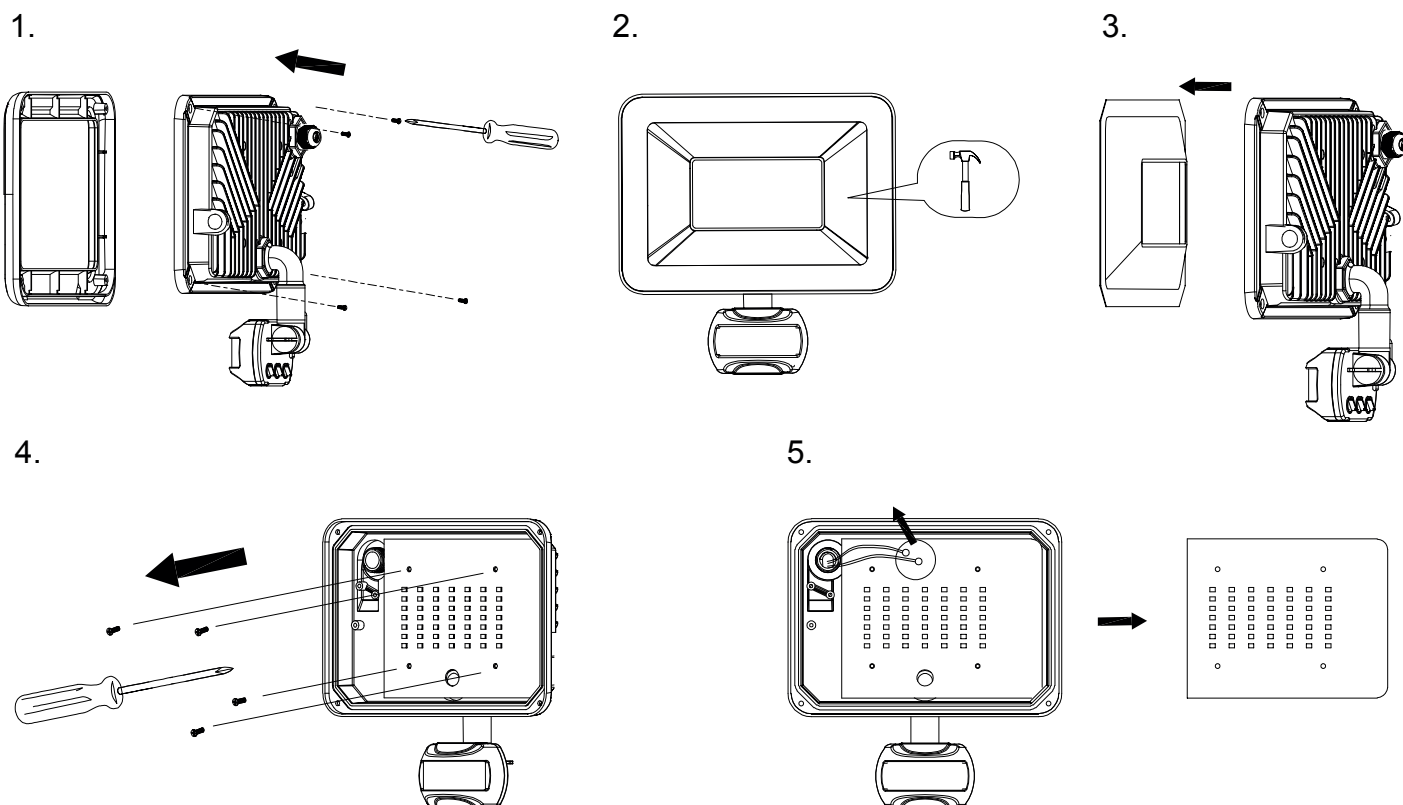

⚠ Avvertenza: I lavori seguenti devono essere eseguiti da un elettricista qualificato.

II.



Utensili richiesti

 Cacciavite con punta a croce

 Martello

⚠ Attenzione: Scollegare il dispositivo dalla rete elettrica prima di effettuare qualsiasi intervento.

Smontaggio

1. Svitare il telaio .
2. Rompere il vetro protettivo  e rimuoverlo.
3. Rimuovere lo schermo metallico.
4. Allentare le viti dell'unità LED integrata con il cacciavite .
5. Allentare il cavo e rimuovere la scheda LED integrata con il cacciavite.

III.

Smaltire i componenti specifici secondo le normative vigenti!

HORNBACH Baumarkt AG
Hornbachstr. 11
76879 Bornheim / Germania

www.hornbach.com

10599900

LED-BUITENARMATUUR MET PIR-SENSOR

Demontage en verwijdering

I.

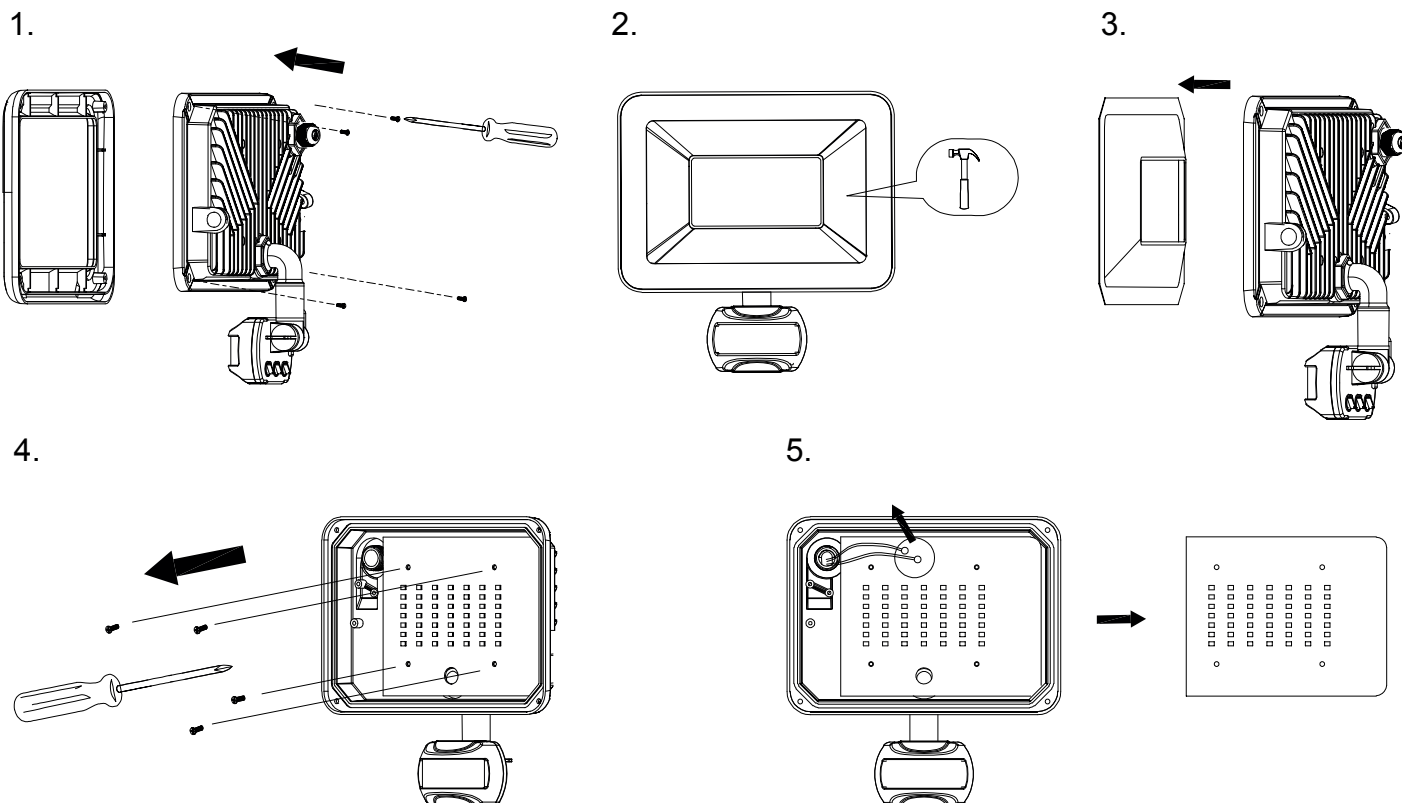

⚠ Waarschuwing: Laat de volgende werkzaamheden aan een vakbekwame elektricien over.

II.



Benodigd gereedschap

 Kruiskopschroevendraaier

 Hamer

⚠ Voorzichtig: Haal de stekker uit het stopcontact voordat u werkzaamheden aan het apparaat uitvoert.

Demontage

1. Schroef het frame los .
2. Breek het beschermende glas  en verwijder het.
3. Verwijder het metalen scherm.
4. Draai de schroeven van de geïntegreerde LED-eenheid met driver  los.
5. Maak de kabel los en verwijder de geïntegreerde LED-print met driver.

III.

Gooi de individuele onderdelen weg volgens de geldende voorschriften!

HORNBACH Baumarkt AG
Hornbachstr. 11
76879 Bornheim / Duitsland

www.hornbach.com

10599900

LED- UTOMHUSARMATUR MED PIR-SENSOR

Demontering och kassering

I.

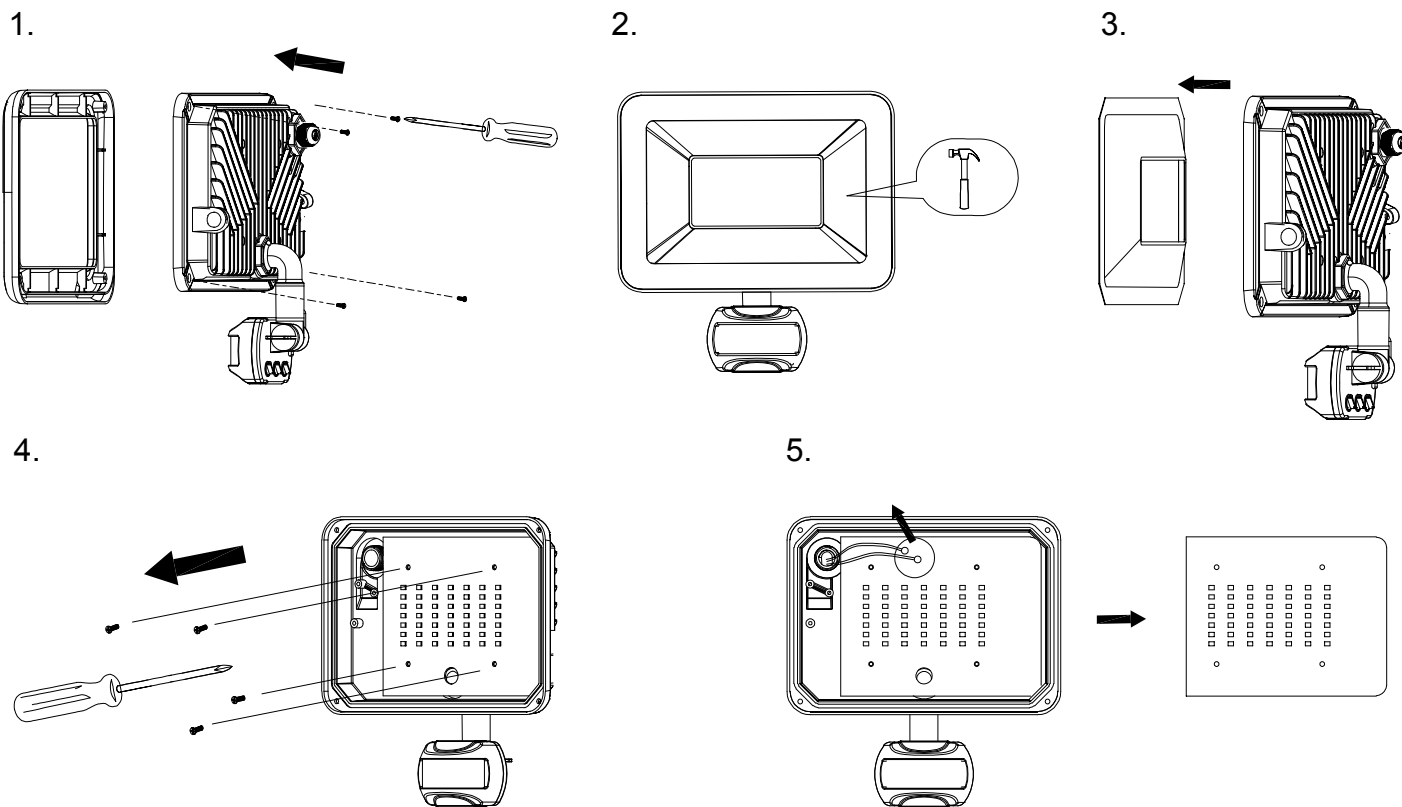

⚠ Varning: Följande arbeten måste utföras av en behörig elektriker.

II.



Verktyg som krävs

 Stjärnskruvmejsel

 Hammare

⚠ Observera: Koppla bort från elnätet innan något arbete på enheten påbörjas.

Demontera

1. Skruva loss ramen .
2. Slå sönder skyddsglasat  och plocka bort det.
3. Ta bort metallskärmen.
4. Lossa skruvarna på den integrerade LED-enheten med drivenhet .
5. Lossa kabeln och ta bort det integrerade LED-kortet med drivrutin.

III.

Kassera de enskilda delarna enligt gällande bestämmelser!

HORNBACH Baumarkt AG
Hornbachstr. 11
76879 Bornheim / Tyskland

www.hornbach.com

10599900

VENKOVNÍ LED SVÍTIDLO S PIR ČIDLEM

Demontáž a likvidace

I.

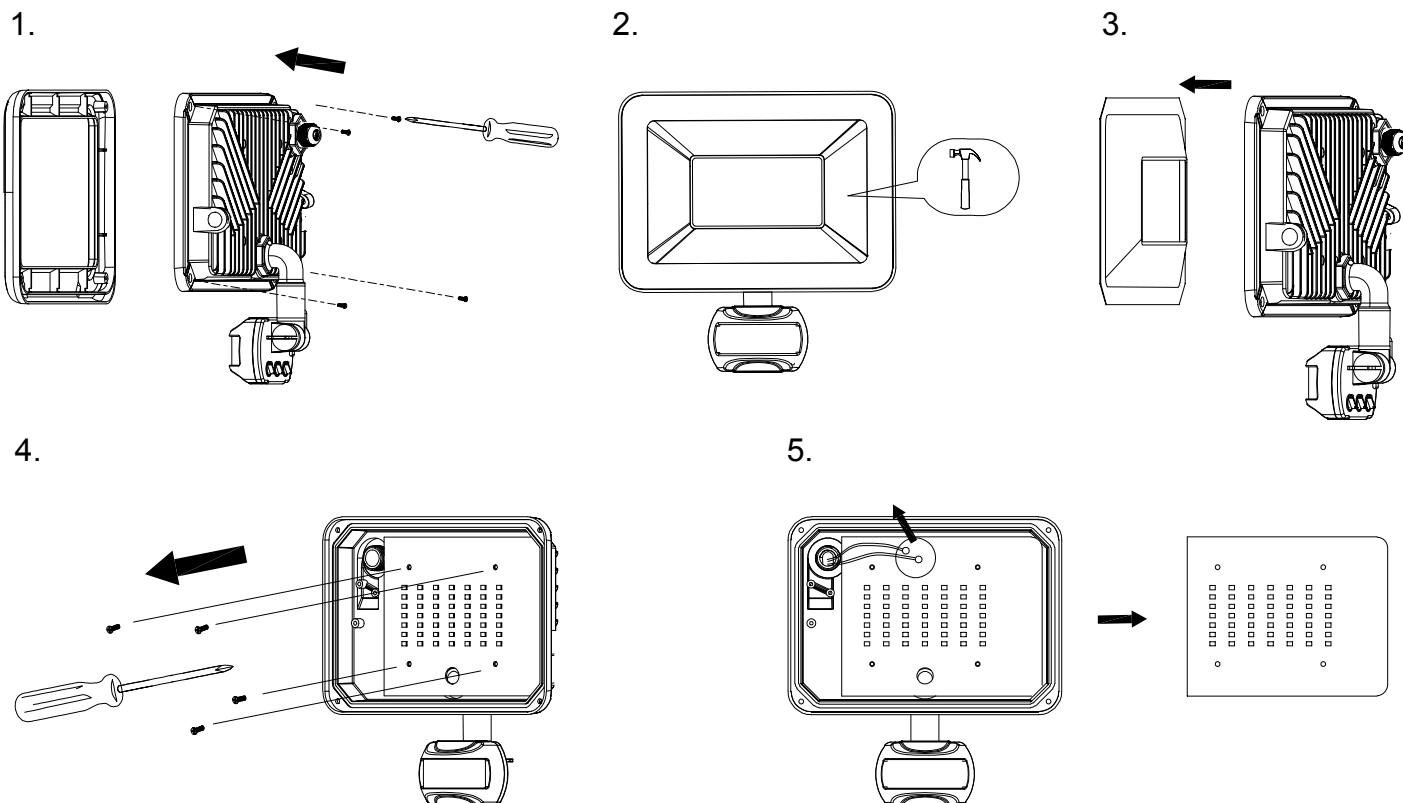

⚠ Výstraha: Následující práce smí provádět pouze kvalifikovaný elektrikář.

II.



Potřebné nářadí

 Křížový šroubovák

 Kladivo

⚠ Upozornění: Před jakýmkoli úkonem na zařízení jej odpojte od elektrické sítě.

Demontáž

1. Odšroubujte rám .
2. Rozbijte ochranné sklo  a odstraňte jej.
3. Odstraňte kovovou mřížku.
4. Šroubovákem povolte šrouby integrované LED jednotky .
5. Uvolněte kabel a odstraňte integrovanou desku LED s ovladačem.

III.

Jednotlivé součásti zlikvidujte v souladu s platnými předpisy!

HORNBACH Baumarkt AG
Hornbachstr. 11
76879 Bornheim / Německo

www.hornbach.com

10599900

VONKAJŠIE LED SVIETIDLO SO SNÍMAČOM PIR

Demontáž a likvidácia

I.

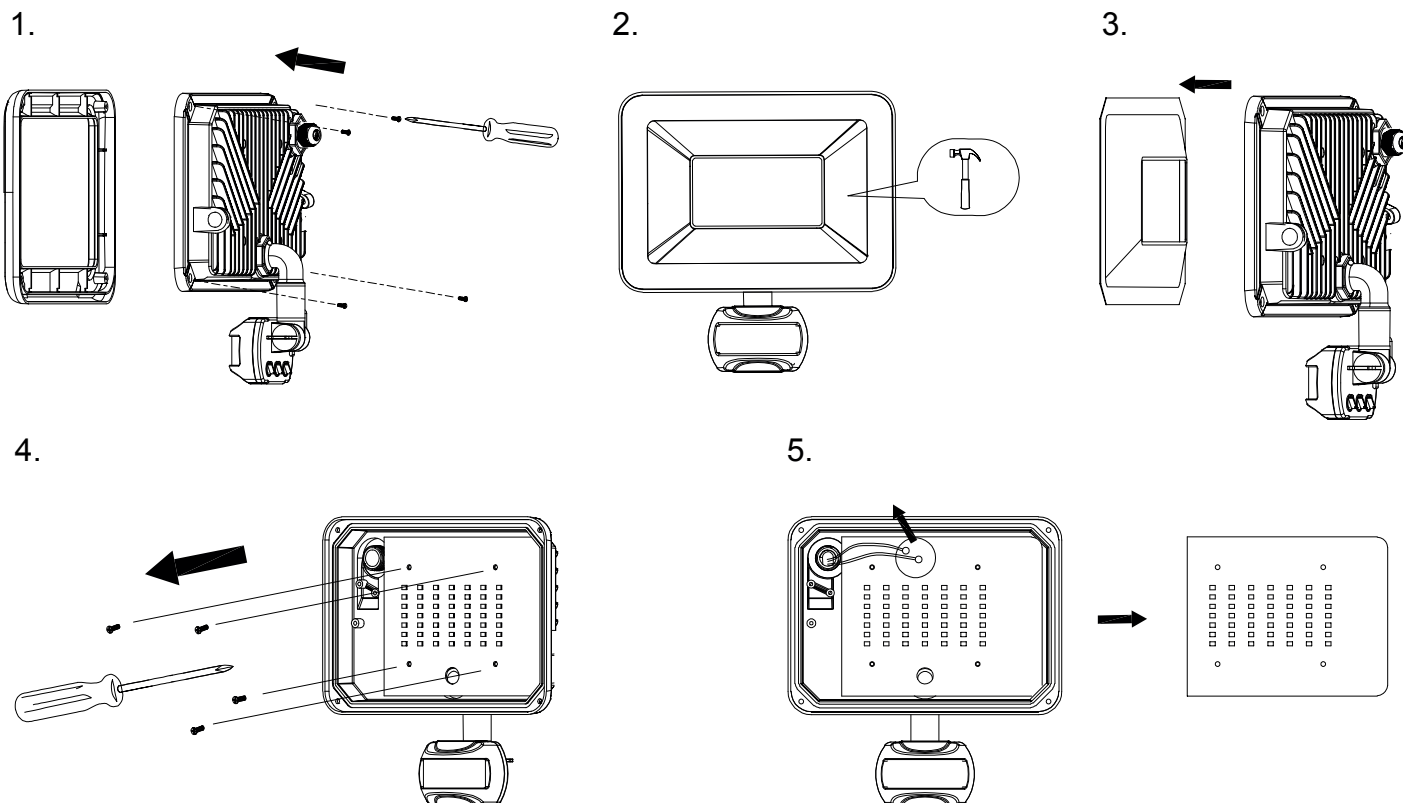

⚠ Výstraha: Nasledujúce práce musí vykonávať kvalifikovaný elektrikár.

II.



Požadované nástroje

 Skrutkovač s krížovým hrotom

 Kladivo

⚠ Upozornenie: Pred akoukoľvek operáciou so zariadením ho odpojte od elektrickej siete.

Demontáž

1. Odskrutkujte rám .
2. Rozbite ochranné sklo  a odstráňte ho.
3. Odstráňte kovovú sieťku.
4. Uvoľnite skrutky integrovanej LED jednotky s ovládačom .
5. Uvoľnite kábel a vyberte integrovanú dosku LED s ovládačom.

III.

Jednotlivé komponenty zlikvidujte v súlade s platnými predpismi!

HORNBACH Baumarkt AG
Hornbachstr. 11
76879 Bornheim / Nemecko

www.hornbach.com

10599900

LAMPĂ DE LUCRU EXTERIOARĂ CU LED CU SENZOR PIR

Demontare și eliminare

I.

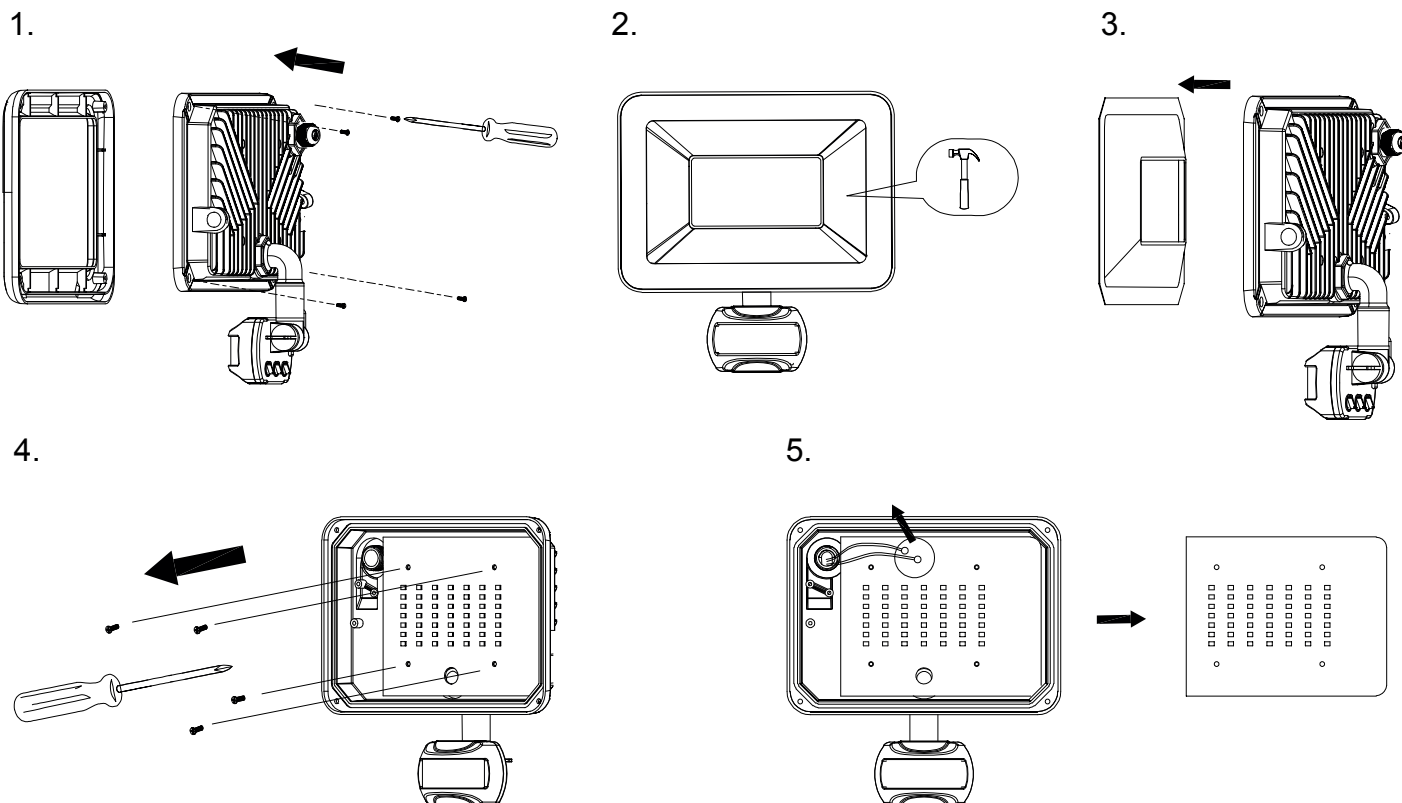

⚠ Avertisment: Lucrările de mai jos trebuie efectuate de un electrician calificat.

II.



Scule necesare

 Șurubelniță în cruce

 Ciocan

⚠ Atenție: Deconectați de la rețeaua electrică înainte de orice operațiune asupra dispozitivului.

Demontarea

1. Deșurubați cadrul .
2. Spargeți geamul de protecție  și îndepărtați-l.
3. Îndepărtați ecranul metalic.
4. Slăbiți șuruburile unității cu LED integrate cu unitatea de control .
5. Slăbiți cablul și scoateți placa cu LED integrată cu unitatea de control.

III.

Eliminați componentele individuale conform reglementărilor în vigoare!

HORNBACH Baumarkt AG
Hornbachstr. 11
76879 Bornheim / Germania

www.hornbach.com

10599900

LED OUTDOOR LUMINAIRE WITH PIR SENSOR

Dismounting and disposal

I.

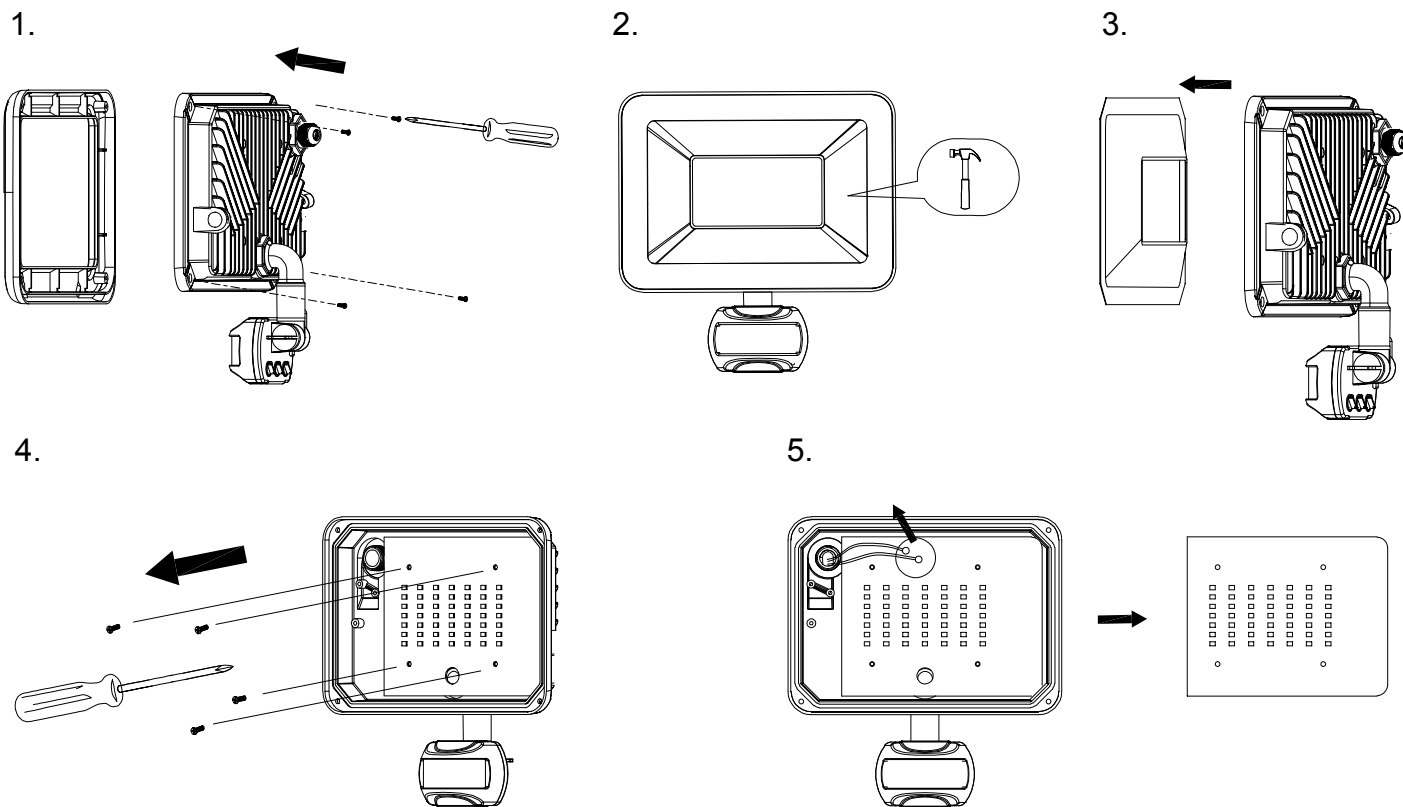

Warning: The following work must be performed by a qualified electrician.

II.



Required tools

 Cross-tip screwdriver

 Hammer

Caution: Disconnect from power mains prior to any operations on the device.

Dismounting

1. Unscrew the frame .
2. Break the protective glass  and remove it.
3. Remove the metal screen.
4. Loosen the screws of the integrated LED unit with driver .
5. Loosen the cable and remove the the integrated LED board with driver.

III.

Dispose of the individual components according to the applicable regulations!

HORNBACH Baumarkt AG
Hornbachstr. 11
76879 Bornheim / Germany

www.hornbach.com