

10599981

## LED-AUSSENLEUCHE MIT BEWEGUNGSSENSOR

### Demontage und Entsorgung

I.

1.

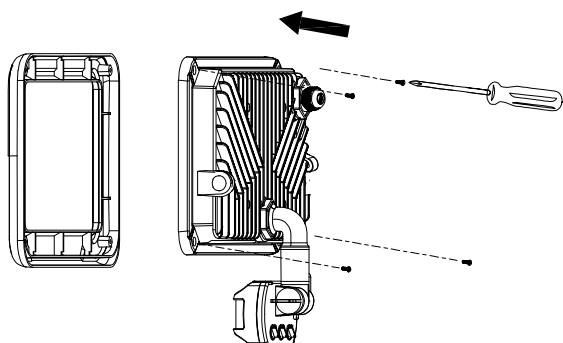

2.

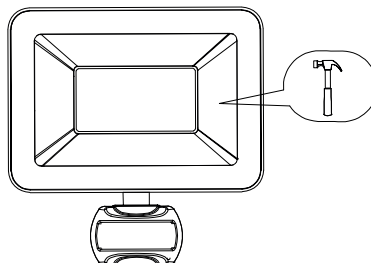

3.

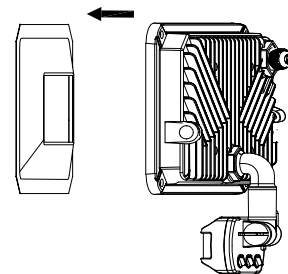

4.

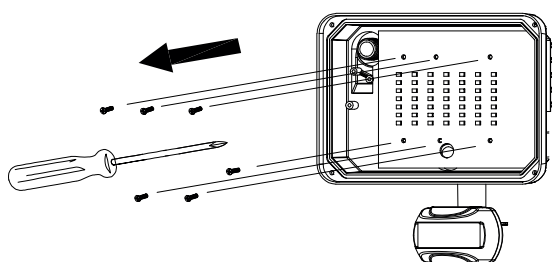

5.

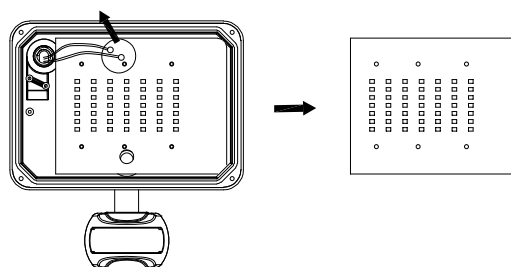

**⚠️ Warnung:** Die folgenden Arbeitsschritte dürfen nur von Elektrofachkräften durchgeführt werden.

II.



#### Benötigtes Werkzeug

 Kreuzschlitzschraubendreher

 Hammer

**⚠️ Vorsicht:** Vor jeglichen Arbeiten am Gerät die Leuchte vom Netz trennen.

#### Demontage

1. Den Rahmen abschrauben .
2. Das fest verklebte Schutzglas zerstören  und entfernen.
3. Den Metallschirm abnehmen.
4. Die Schrauben der integrierten Leuchteinheit mit Betriebsgerät lösen .
5. Das Kabel lösen und die integrierte LED-Platine mit Betriebsgerät entnehmen.

III.

Die einzelnen Bauteile entsprechend geltenden Vorschriften entsorgen!

HORNBACH Baumarkt AG  
Hornbachstraße 11  
76879 Bornheim / Deutschland

[www.hornbach.com](http://www.hornbach.com)

10599981

## LAMPE EXTÉRIURE À LED AVEC DÉTECTEUR PIR

### Démontage et mise au rebut

I.

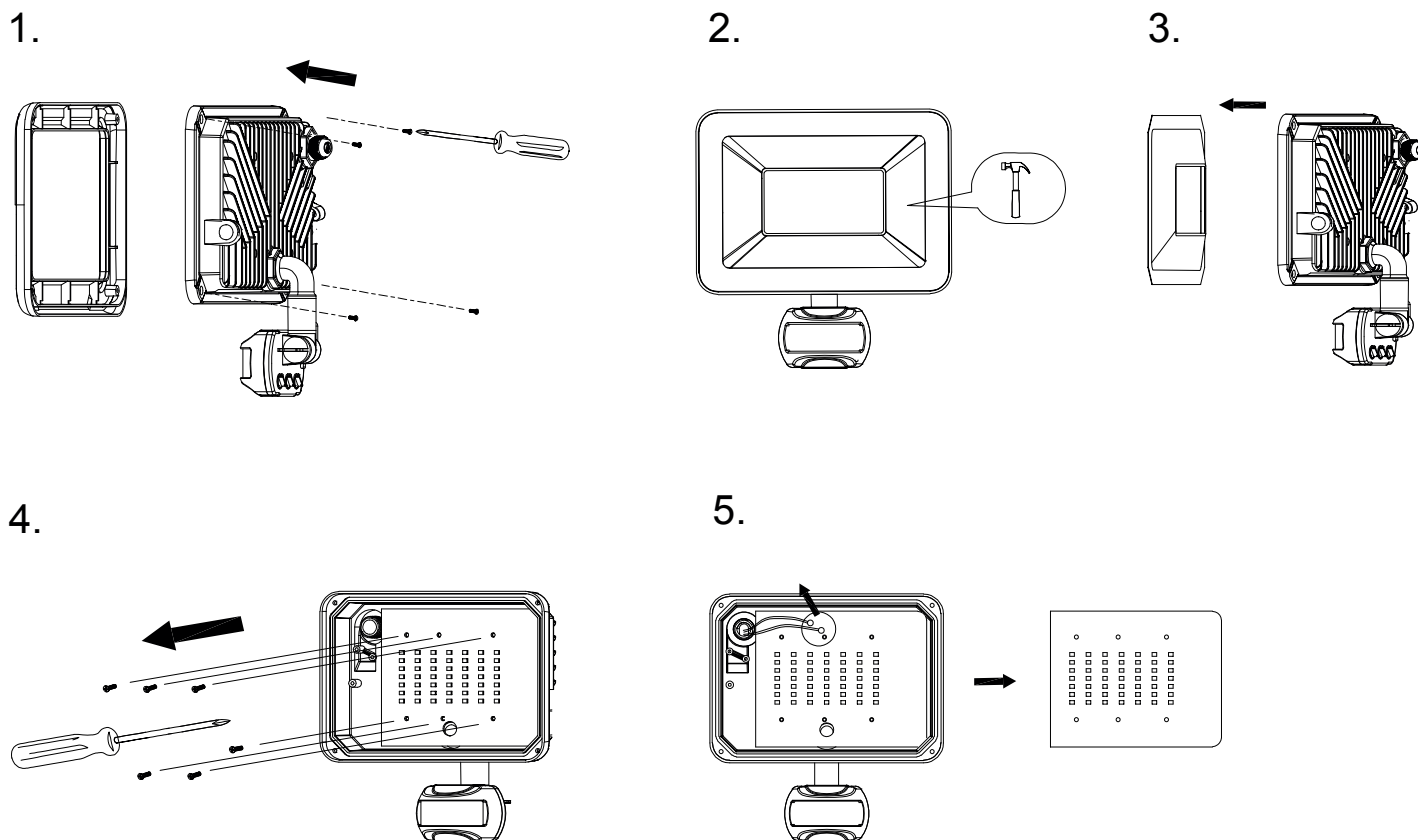

**⚠ Avertissement : Les opérations suivantes doivent être effectuées par un électricien qualifié.**

II.



#### Outils nécessaires

 Tournevis cruciforme

 Marteau

**⚠ Attention : Débranchez du secteur avant d'intervenir sur l'appareil.**

#### Démontage

1. Dévissez le châssis .
2. Brisez la verre de protection  et retirez-le.
3. Retirez la plaque métallique.
4. Dévissez les vis de l'unité à LED intégrée avec un tournevis .
5. Desserrez le câble et retirez la carte à LED intégrée avec un tournevis.

III.

**Mettez les différents composants au rebut selon les réglementations applicables !**

HORNBACH Baumarkt AG  
Hornbachstr. 11  
76879 Bornheim / Allemagne

[www.hornbach.com](http://www.hornbach.com)

10599981

## LAMPADA DA ESTERNO A LED CON SENSORE PIR

### Smontaggio e smaltimento

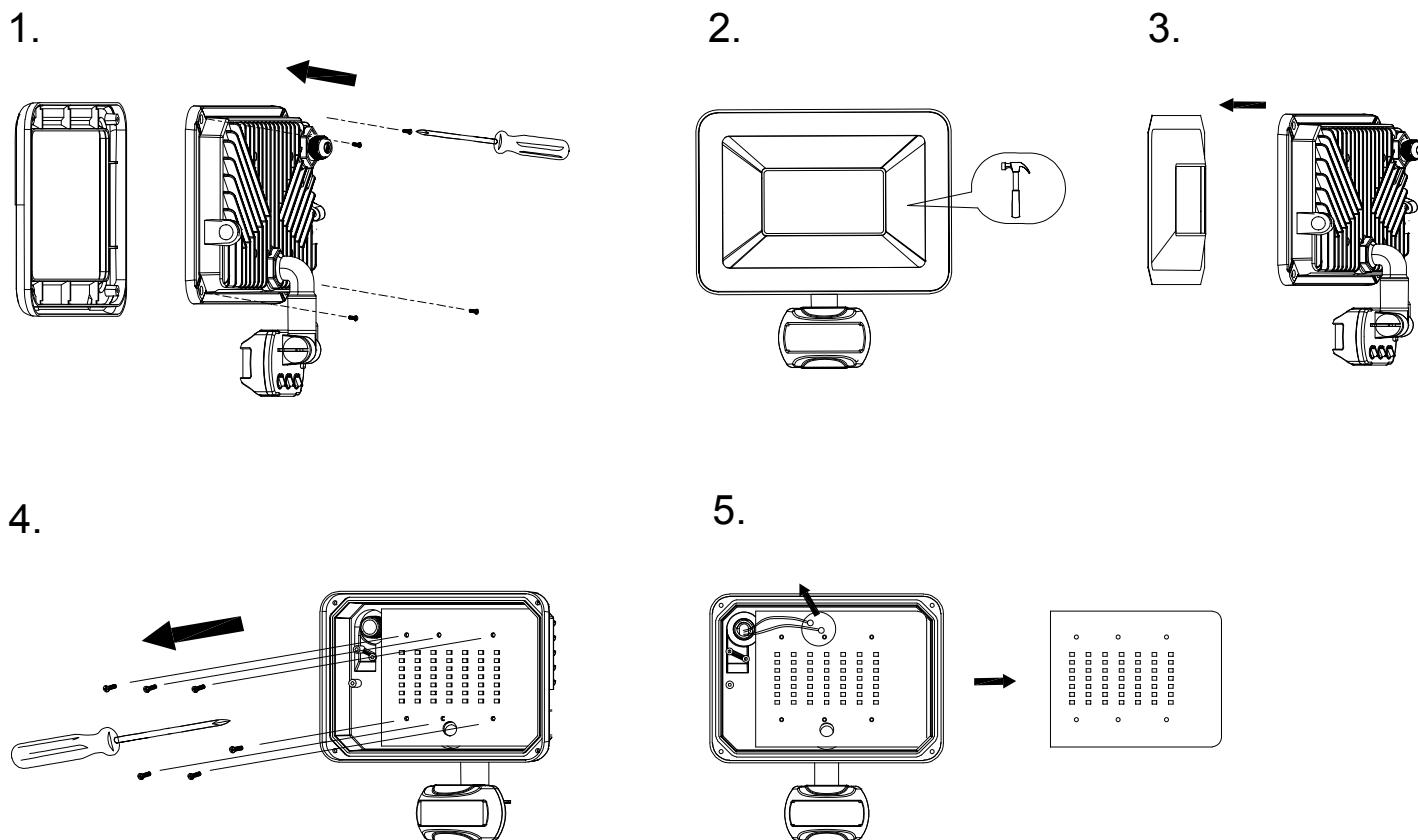

I.



**⚠ Avvertenza: I lavori seguenti devono essere eseguiti da un elettricista qualificato.**



II.

#### Utensili richiesti

-  Cacciavite con punta a croce
-  Martello

**⚠ Attenzione: Scollegare il dispositivo dalla rete elettrica prima di effettuare qualsiasi intervento.**

#### Smontaggio

1. Svitare il telaio .
2. Rompere il vetro protettivo  e rimuoverlo.
3. Rimuovere lo schermo metallico.
4. Allentare le viti dell'unità LED integrata con il cacciavite .
5. Allentare il cavo e rimuovere la scheda LED integrata con il cacciavite.

III.

**Smaltire i componenti specifici secondo le normative vigenti!**

HORNBACH Baumarkt AG  
Hornbachstr. 11  
76879 Bornheim / Germania

[www.hornbach.com](http://www.hornbach.com)

10599981

## LED-BUITENARMATUUR MET PIR-SENSOR

### Demontage en verwijdering

I.

1.

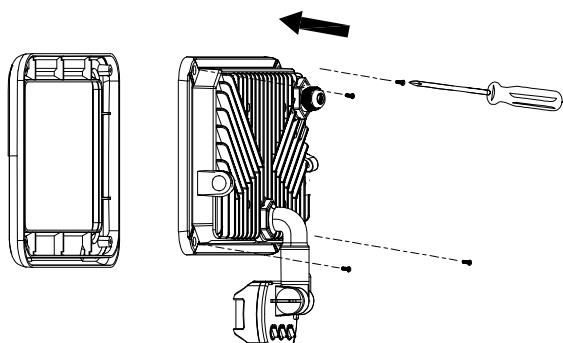

2.

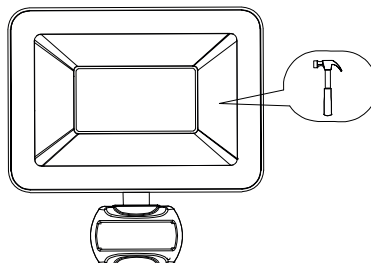

3.

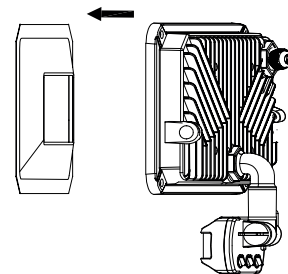

4.

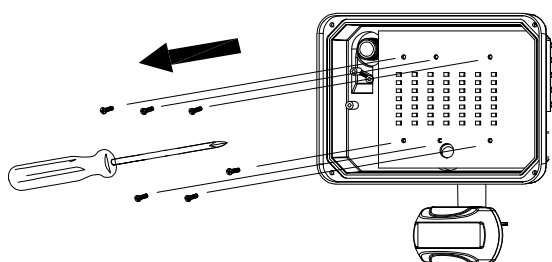

5.

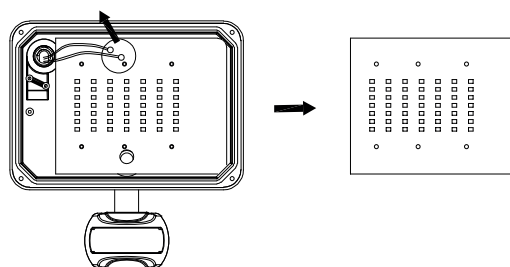

**⚠ Waarschuwing: Laat de volgende werkzaamheden aan een vakbekwame elektricien over.**

II.



#### Benodigd gereedschap

 Kruiskopschroevendraaier

 Hamer

**⚠ Voorzichtig: Haal de stekker uit het stopcontact voordat u werkzaamheden aan het apparaat uitvoert.**

#### Demontage

1. Schroef het frame los .
2. Breek het beschermende glas  en verwijder het.
3. Verwijder het metalen scherm.
4. Draai de schroeven van de geïntegreerde LED-eenheid met driver  los.
5. Maak de kabel los en verwijder de geïntegreerde LED-print met driver.

III.

**Gooi de individuele onderdelen weg volgens de geldende voorschriften!**

HORNBACH Baumarkt AG  
Hornbachstr. 11  
76879 Bornheim / Duitsland

[www.hornbach.com](http://www.hornbach.com)

10599981

## LED- UTOMHUSARMATUR MED PIR-SENSOR

### Demontering och kassering

I.

1.

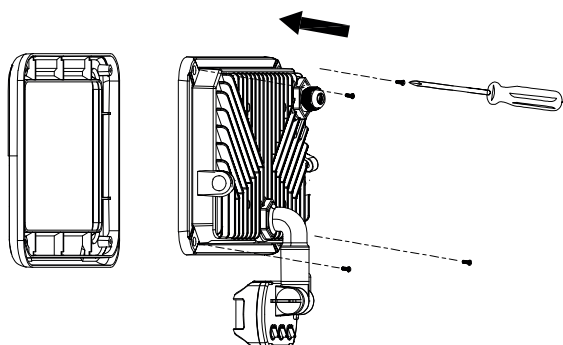

2.

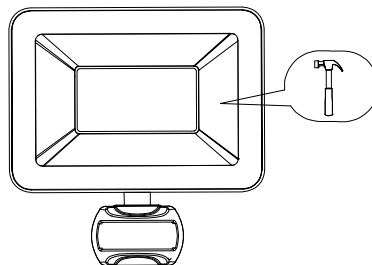

3.

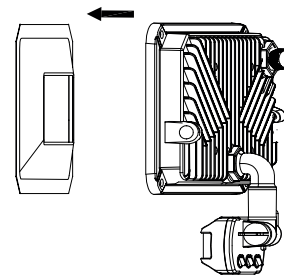

4.

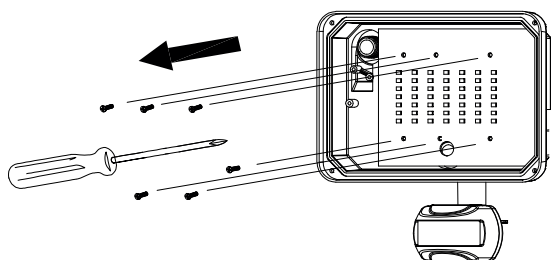

5.

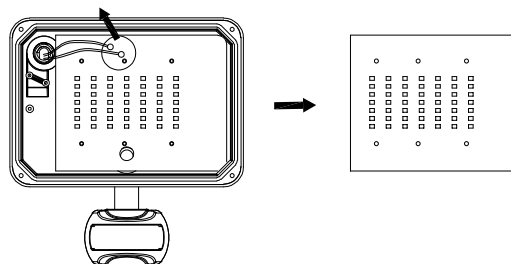

**⚠ Varning: Följande arbeten måste utföras av en behörig elektriker.**

II.



#### Verktyg som krävs

 Stjärnskruvmejsel

 Hammare

**⚠ Observera: Koppla bort från elnätet innan något arbete på enheten påbörjas.**

#### Demontera

1. Skruva loss ramen .
2. Slå sönder skyddsglasat  och plocka bort det.
3. Ta bort metallskärmen.
4. Lossa skruvarna på den integrerade LED-enheten med drivenhet .
5. Lossa kabeln och ta bort det integrerade LED-kortet med drivrutin.

III.

**Kassera de enskilda delarna enligt gällande bestämmelser!**

HORNBACH Baumarkt AG  
Hornbachstr. 11  
76879 Bornheim / Tyskland

[www.hornbach.com](http://www.hornbach.com)

# 10599981

## VENKOVNÍ LED SVÍTIDLO S PIR ČIDLEM

### Demontáž a likvidace

I.

1.

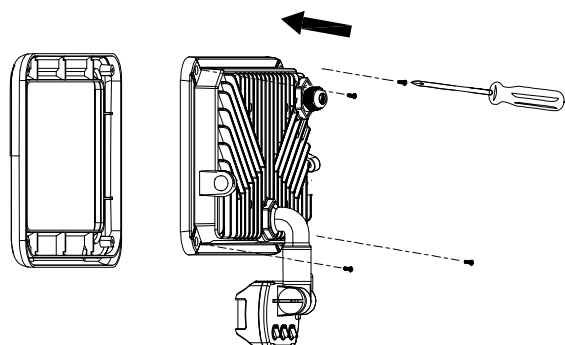

2.

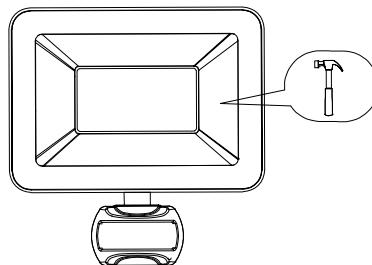

3.

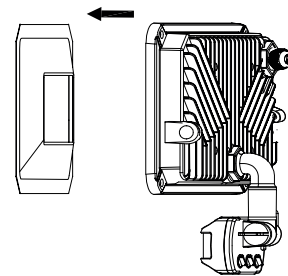

4.

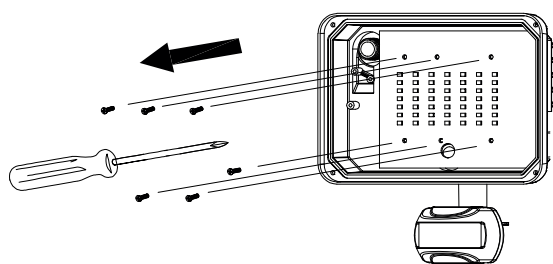

5.

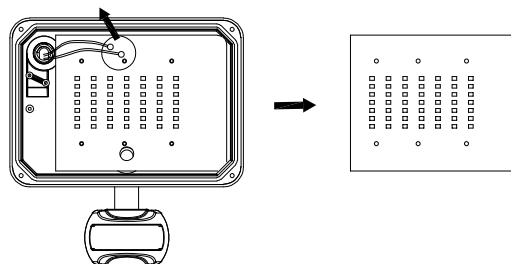

**⚠ Výstraha: Následující práce smí provádět pouze kvalifikovaný elektrikář.**

II.

#### Potřebné nářadí

⊕ Křížový šroubovák

🔨 Kladivo

**⚠ Upozornění: Před jakýmkoli úkonem na zařízení jej odpojte od elektrické sítě.**

#### Demontáž

1. Odšroubujte rám ⊕.
2. Rozbijte ochranné sklo 🔨 a odstraňte jej.
3. Odstraňte kovovou mřížku.
4. Šroubovákem povolte šrouby integrované LED jednotky ⊕.
5. Uvolněte kabel a odstraňte integrovanou desku LED s ovladačem.

III.

**Jednotlivé součásti zlikvidujte v souladu s platnými předpisy!**

HORNBACH Baumarkt AG  
Hornbachstr. 11  
76879 Bornheim / Německo

[www.hornbach.com](http://www.hornbach.com)

10599981

# VONKAJŠIE LED SVIETIDLO SO SNÍMAČOM PIR

## Demontáž a likvidácia

I.

1.

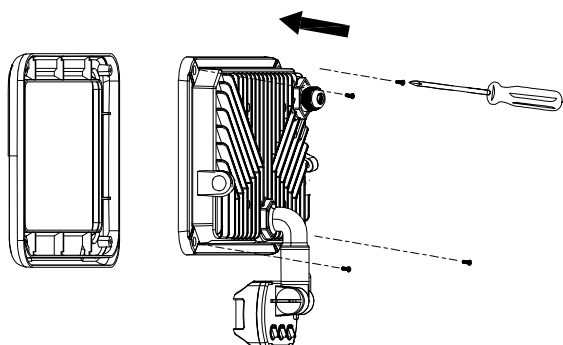

2.

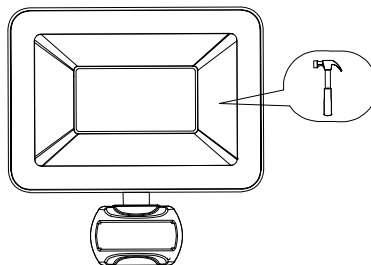

3.

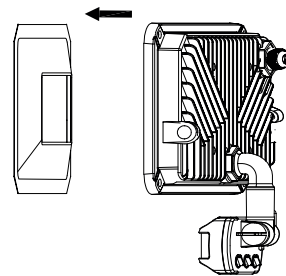

4.

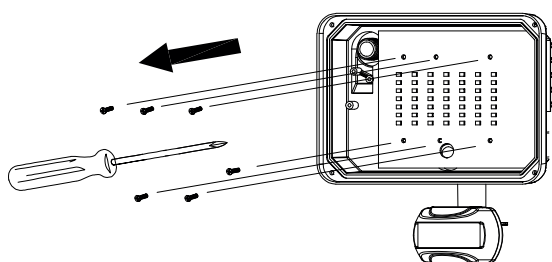

5.

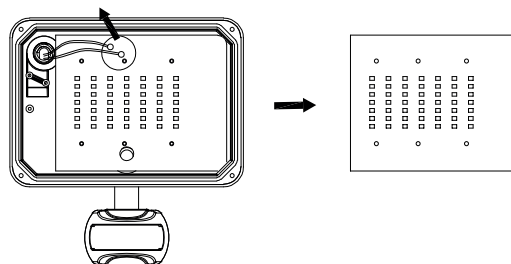

**⚠ Výstraha: Nasledujúce práce musí vykonávať kvalifikovaný elektrikár.**

II.



### Požadované nástroje

 Skrutkovač s krížovým hrotom

 Kladivo

**⚠ Upozornenie: Pred akoukoľvek operáciou so zariadením ho odpojte od elektrickej siete.**

### Demontáž

1. Odskrutkujte rám .
2. Rozbíte ochranné sklo  a odstráňte ho.
3. Odstráňte kovovú sieťku.
4. Uvoľnite skrutky integrovanej LED jednotky s ovládačom .
5. Uvoľnite kábel a vyberte integrovanú dosku LED s ovládačom.

III.

**Jednotlivé komponenty zlikvidujte v súlade s platnými predpismi!**

HORNBACH Baumarkt AG  
Hornbachstr. 11  
76879 Bornheim / Nemecko

[www.hornbach.com](http://www.hornbach.com)

10599981

# LAMPĂ DE LUCRU EXTERIOARĂ CU LED CU SENZOR PIR

## Demontare și eliminare

I.

1.

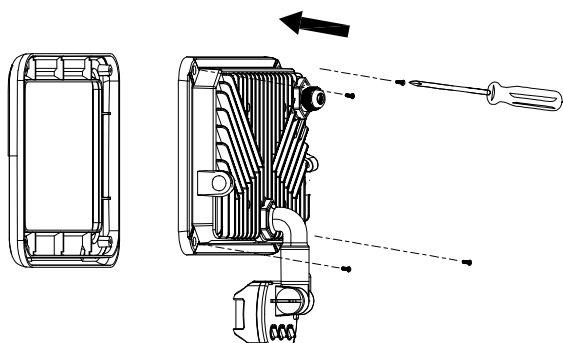

2.

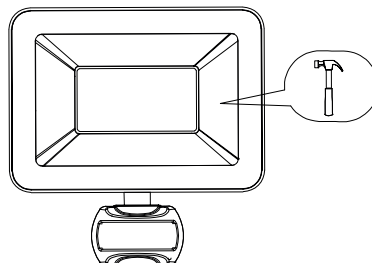

3.

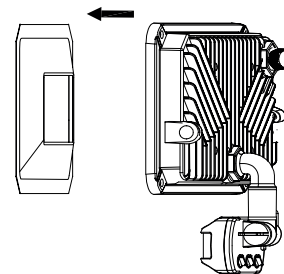

4.

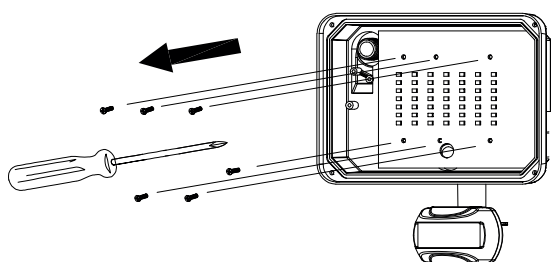

5.

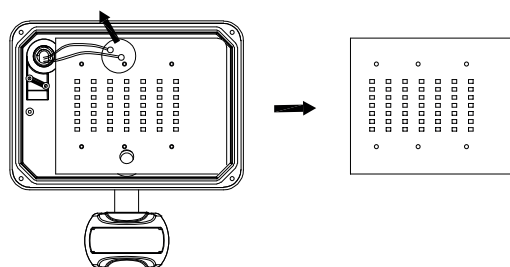

**⚠ Avertisment: Lucrările de mai jos trebuie efectuate de un electrician calificat.**

II.



### Scule necesare

 Șurubelniță în cruce

 Ciocan

**⚠ Atenție: Deconectați de la rețeaua electrică înainte de orice operațiune asupra dispozitivului.**

### Demontarea

1. Deșurubați cadrul .
2. Spargeți geamul de protecție  și îndepărtați-l.
3. Îndepărtați ecranul metalic.
4. Slăbiți șuruburile unității cu LED integrate cu unitatea de control .
5. Slăbiți cablul și scoateți placa cu LED integrată cu unitatea de control.

III.

**Eliminați componentele individuale conform reglementărilor în vigoare!**

HORNBACH Baumarkt AG  
Hornbachstr. 11  
76879 Bornheim / Germania

[www.hornbach.com](http://www.hornbach.com)



10599981

## LED OUTDOOR LUMINAIRE WITH PIR SENSOR

### Dismounting and disposal

I.

1.

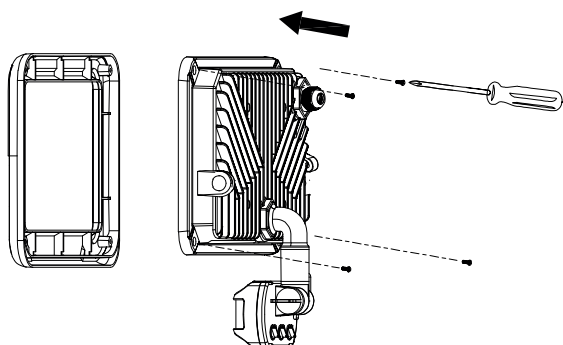

2.

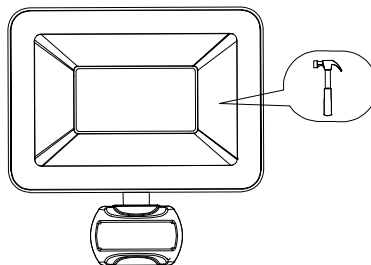

3.

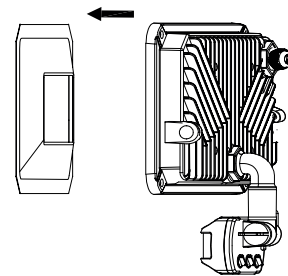

4.

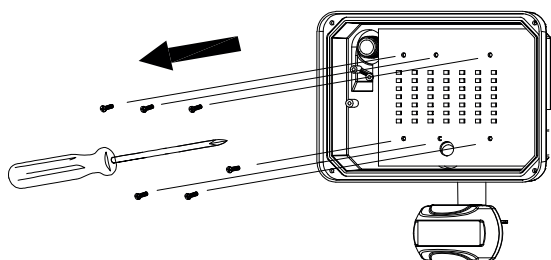

5.

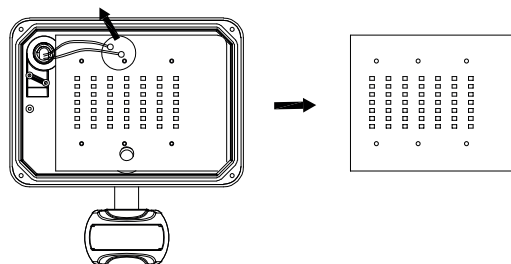

**⚠ Warning: The following work must be performed by a qualified electrician.**

II.



#### Required tools

 Cross-tip screwdriver

 Hammer

**⚠ Caution: Disconnect from power mains prior to any operations on the device.**

#### Dismounting

1. Unscrew the frame .
2. Break the protective glass  and remove it.
3. Remove the metal screen.
4. Loosen the screws of the integrated LED unit with driver .
5. Loosen the cable and remove the the integrated LED board with driver.

III.

**Dispose of the individual components according to the applicable regulations!**

HORNBACH Baumarkt AG  
Hornbachstr. 11  
76879 Bornheim / Germany

[www.hornbach.com](http://www.hornbach.com)