

Orbital Shower - Basic Fixture kit

Floor Fixture kit

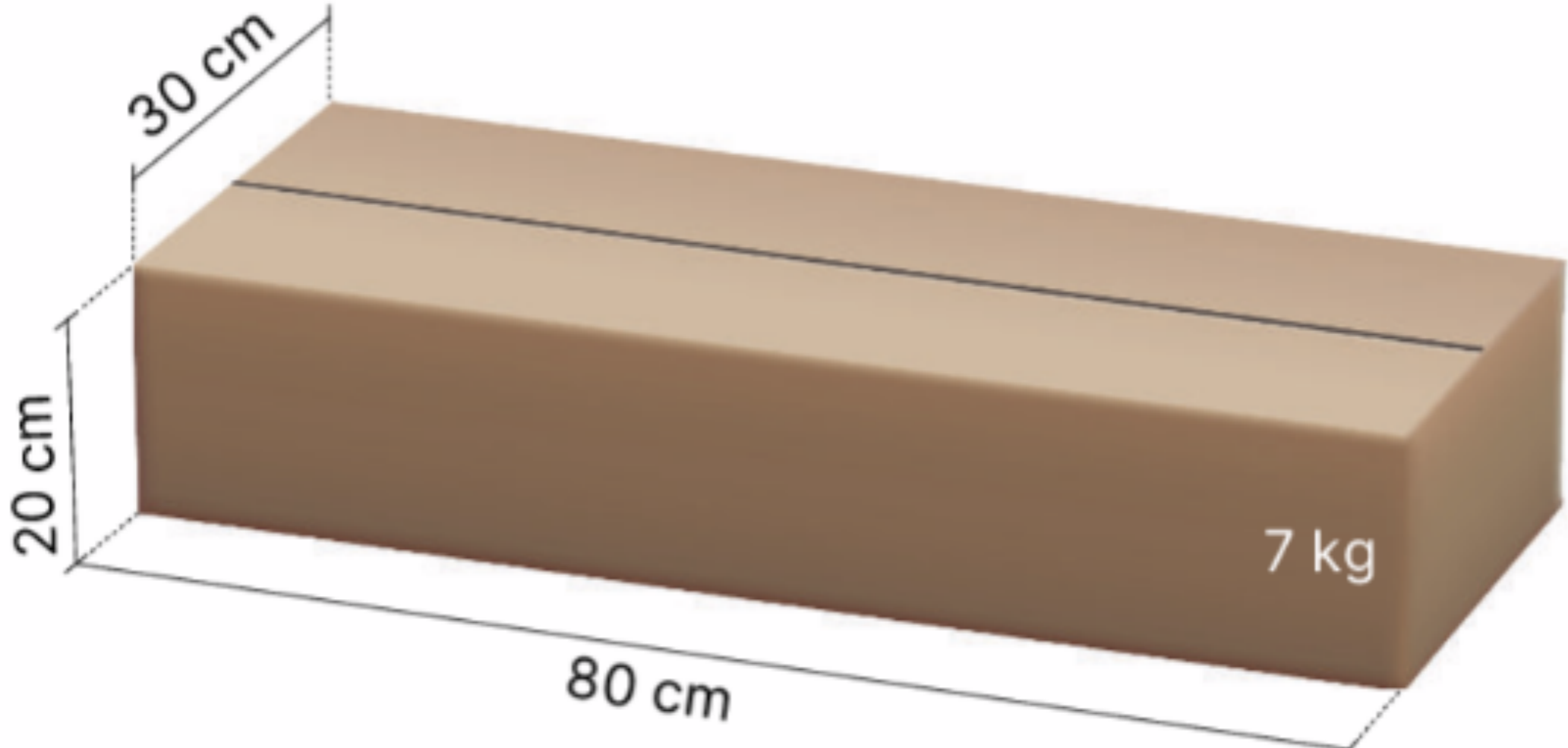

Drain waterproofing membrane



Drain unit



Tiling frame set



Outlet unit

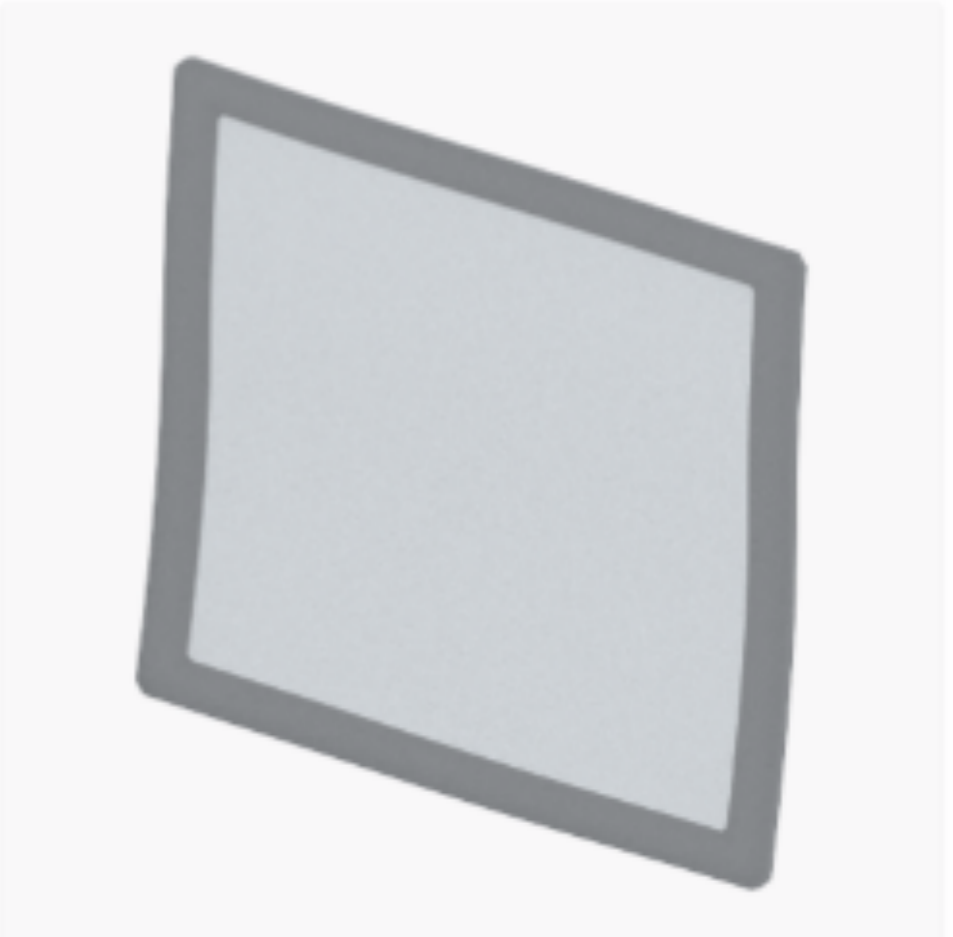

Cleaning wipe



Screws (4) & plugs (4)

Orbital Shower - Basic Fixture kit

Wall Fixture kit

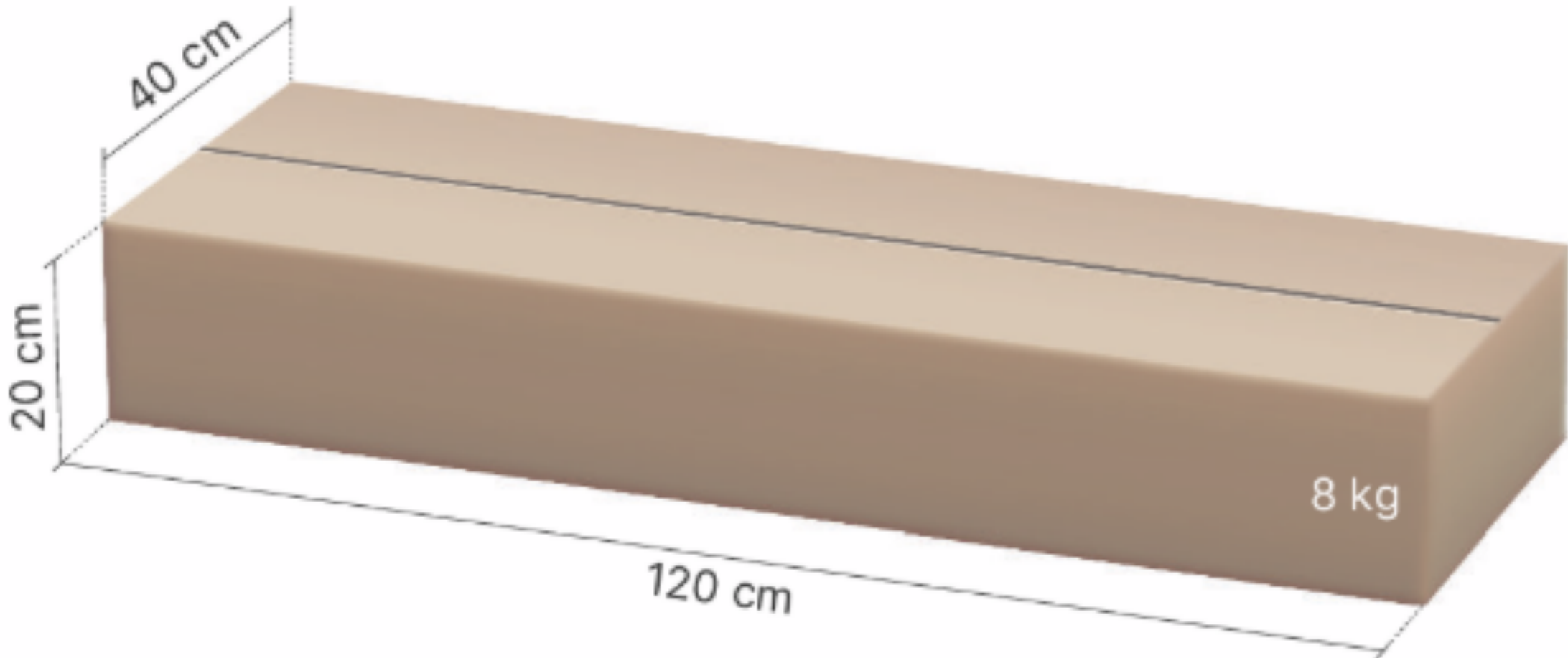

Core Wall Mounting - top bracket + bottom bracket



Screws for the Core Wall Mounting (6)



Braided hose



PEX hose with conduit (1x550cm)



Conduit for the Control Dial (1x350 cm)



Retainer conduit (10)

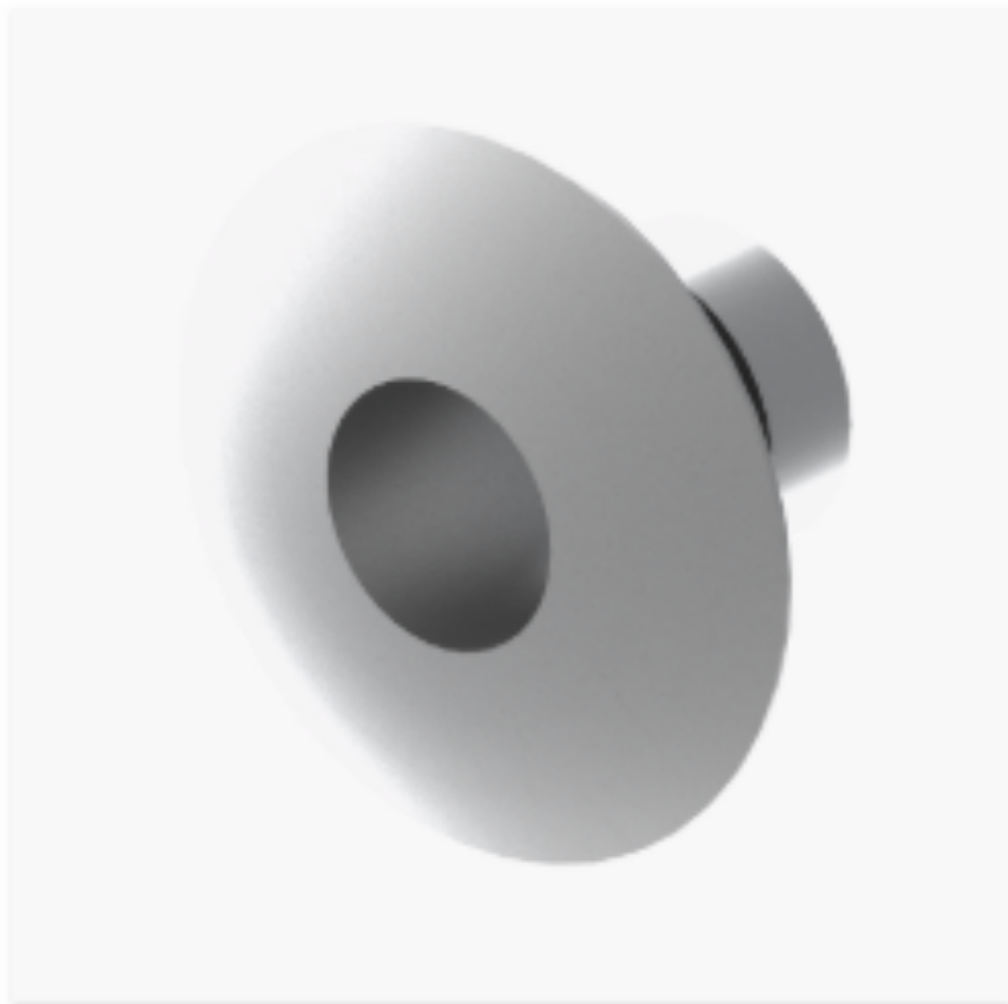

Conduit end cap



Mixer bracket



Wallbox UNI Push V2 & screws (4)



Conduit elbow (5)



Wall pistol mounting plate (3)



Screws for the mounting plate (6)



Reducer 50-40 mm



Fitting, 40 mm x45°, M-F (2)



Bend, 50 mm x 45°, M-F (6)



Drain pipe 50 mm (3x100 cm)



Wi-Fi antenna

Orbital Shower - Basic Technology kit

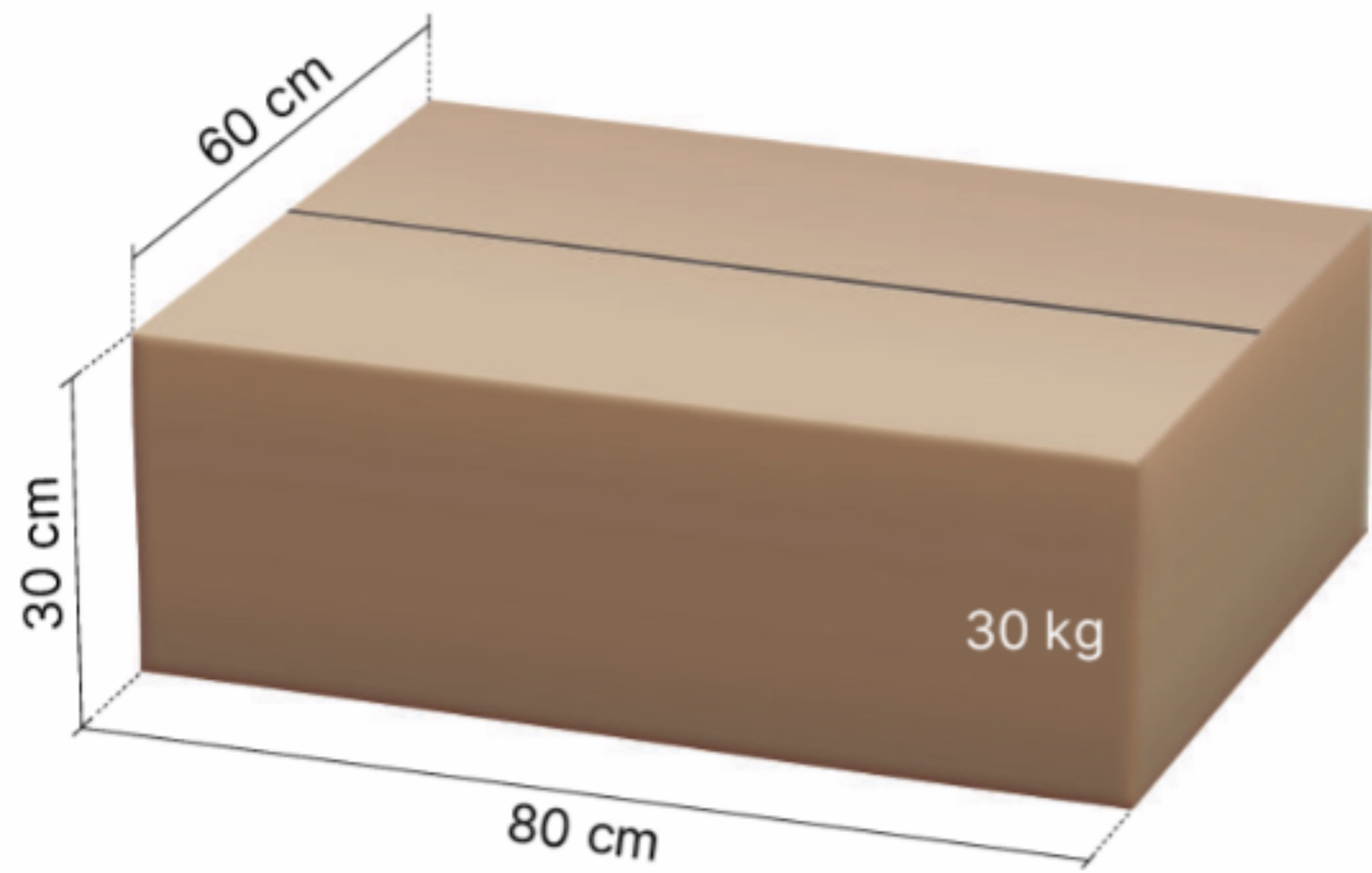

Orbital Shower Core

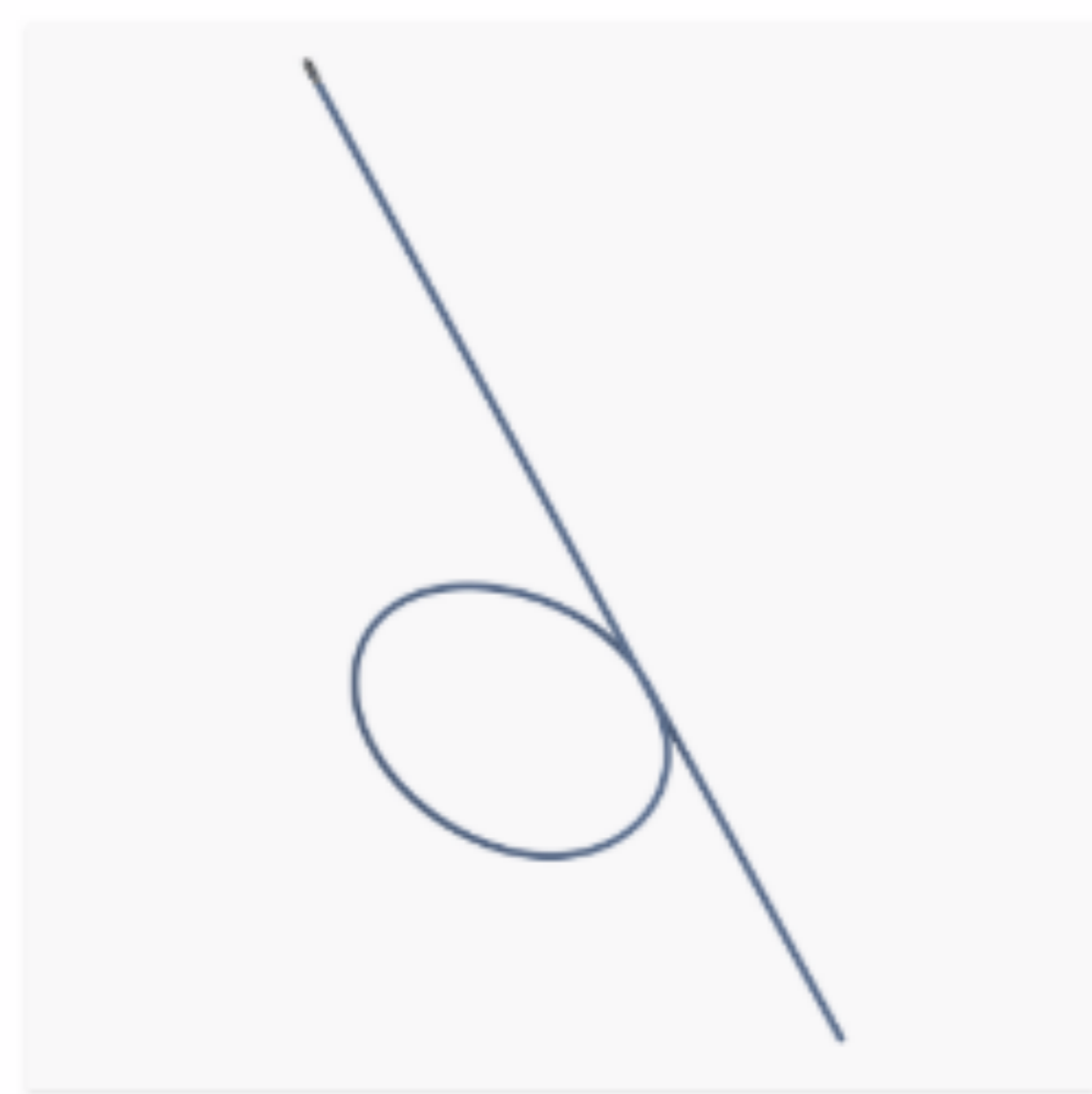

Flush hose



Recirculation hose

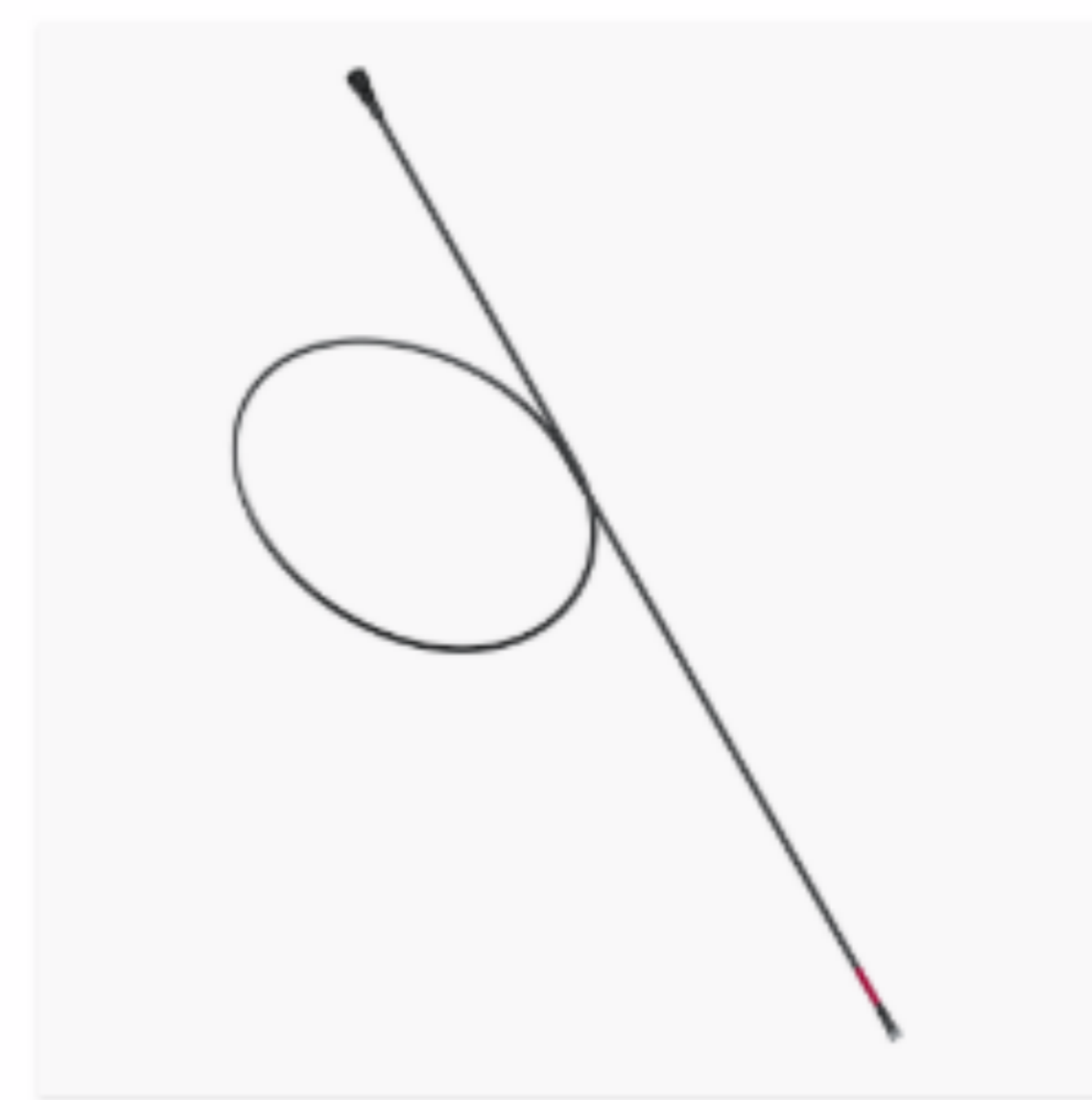

Sensor cable



Ethernet kit



Air gap tank cover



Flush hose kit



Grating tool



Hose connection

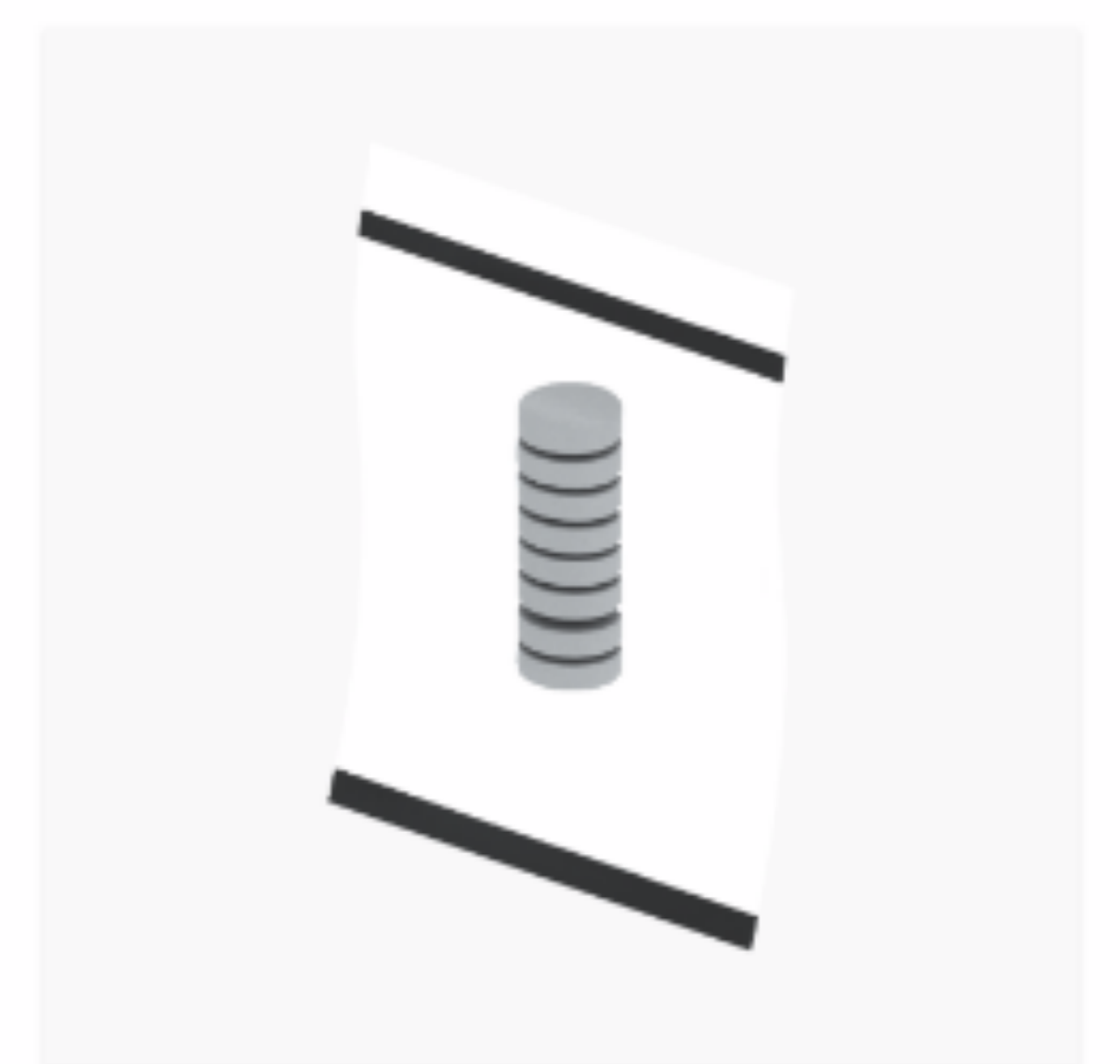

Descal tablets



Spring lock



Clip



Sensor Tank dock



Sensor Tank lock



Sensor Tank



Control Dial, including fixture, screws and extension cable



Filter capsule

Orbital Shower - Basic Technology kit

Black or white shower heads and diverter



Hand shower with hose



Head shower



Head shower arm



Threaded adapter



Diverter body



Diverter wall plate



Hand shower holder cover



Hand shower holder

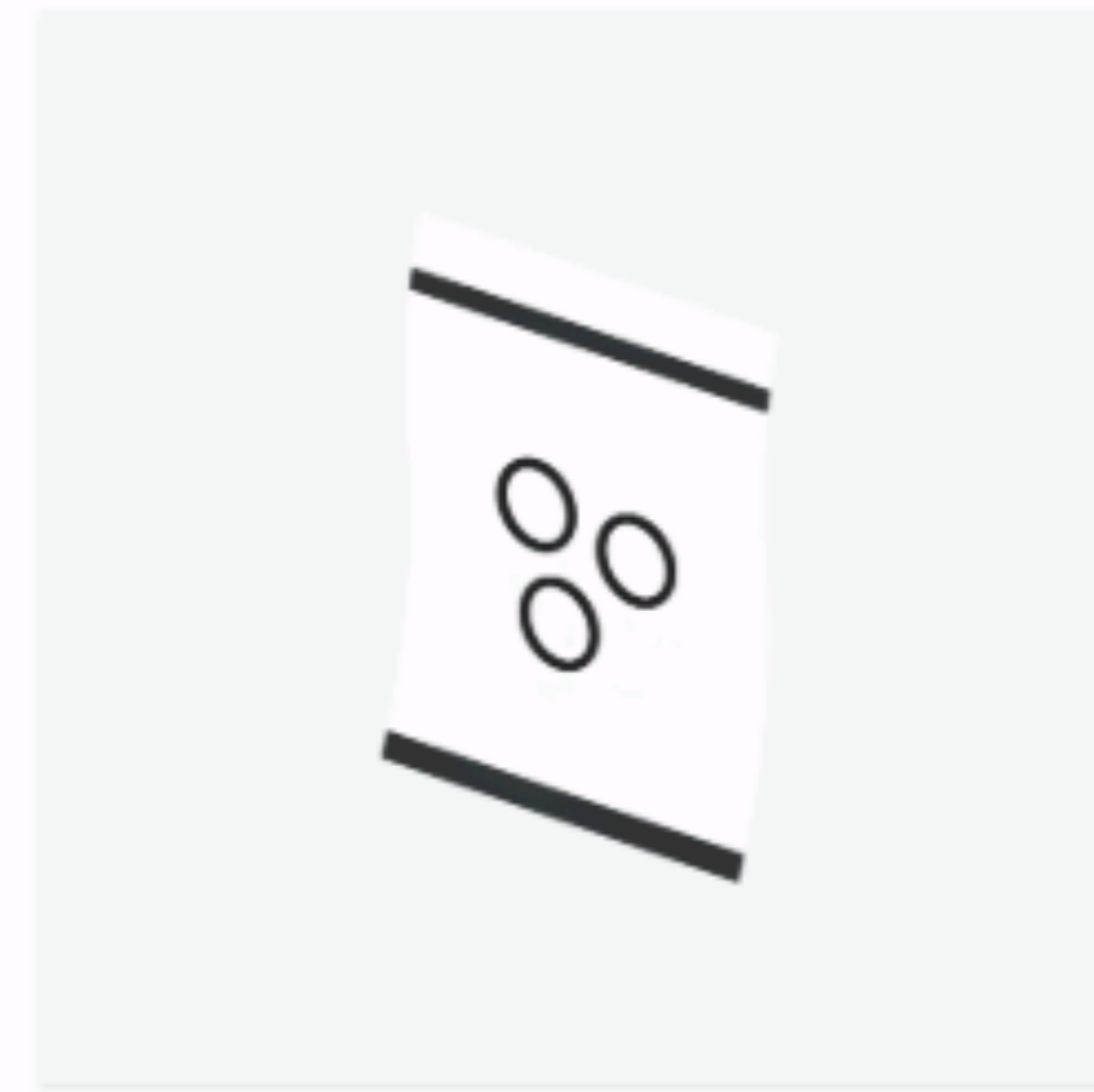

O-ring kit



Screw and tool kit