

Orbital Shower - Tiled Hatch Fixture kit

Floor Fixture kit

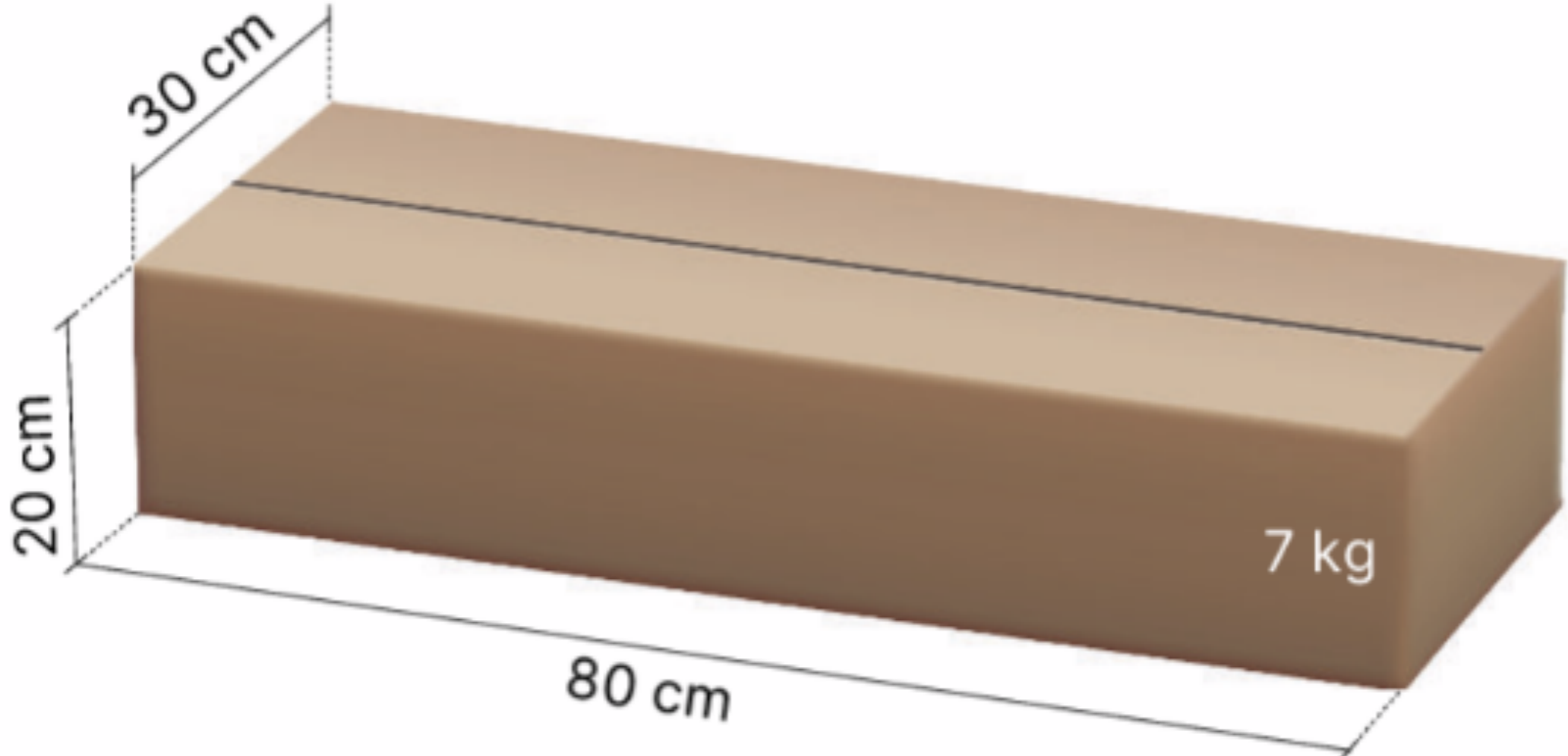

Drain waterproofing membrane



Drain unit



Tiling frame set



Outlet unit

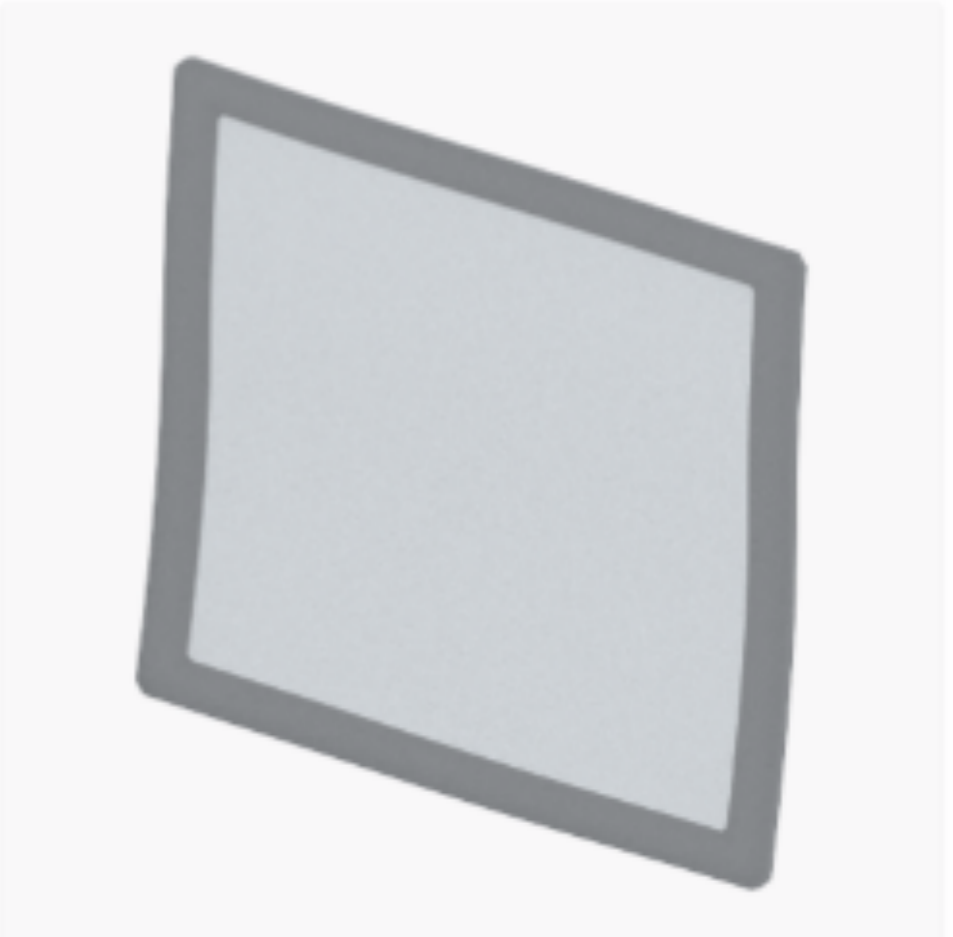

Cleaning wipe



Screws (4) & plugs (4)

Orbital Shower - Tiled Hatch Fixture kit

Wall Fixture kit

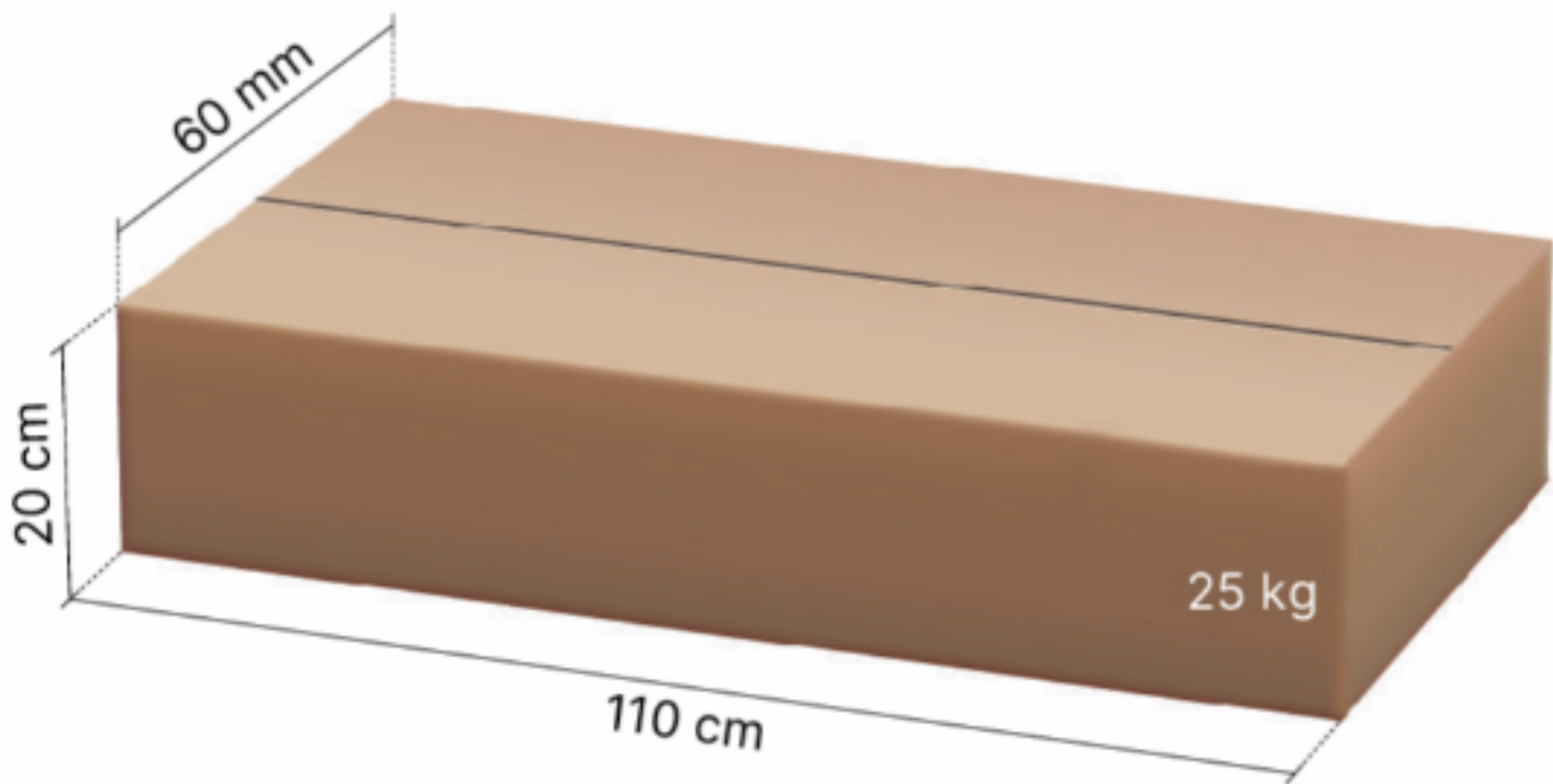

Wall Box and door



Waterproofing membrane



Screws for the Wall Box (8)



Conduit elbow (3)



Wall pistol mounting plate (2)



Screws for the mounting plate (6)



PEX hose with conduit (1x550cm)



Conduit for the Control Dial and leakage indicator (2x350 cm)



Pipe clamps (2)



Retainer conduit (10)



Wallbox UNI Push V2 & screws (4)



Drain pipe 50 mm (3x100 cm)



Fitting, 40 mm x45°, M-F (2)



Bend, 50 mm x 45°, M-F (6)

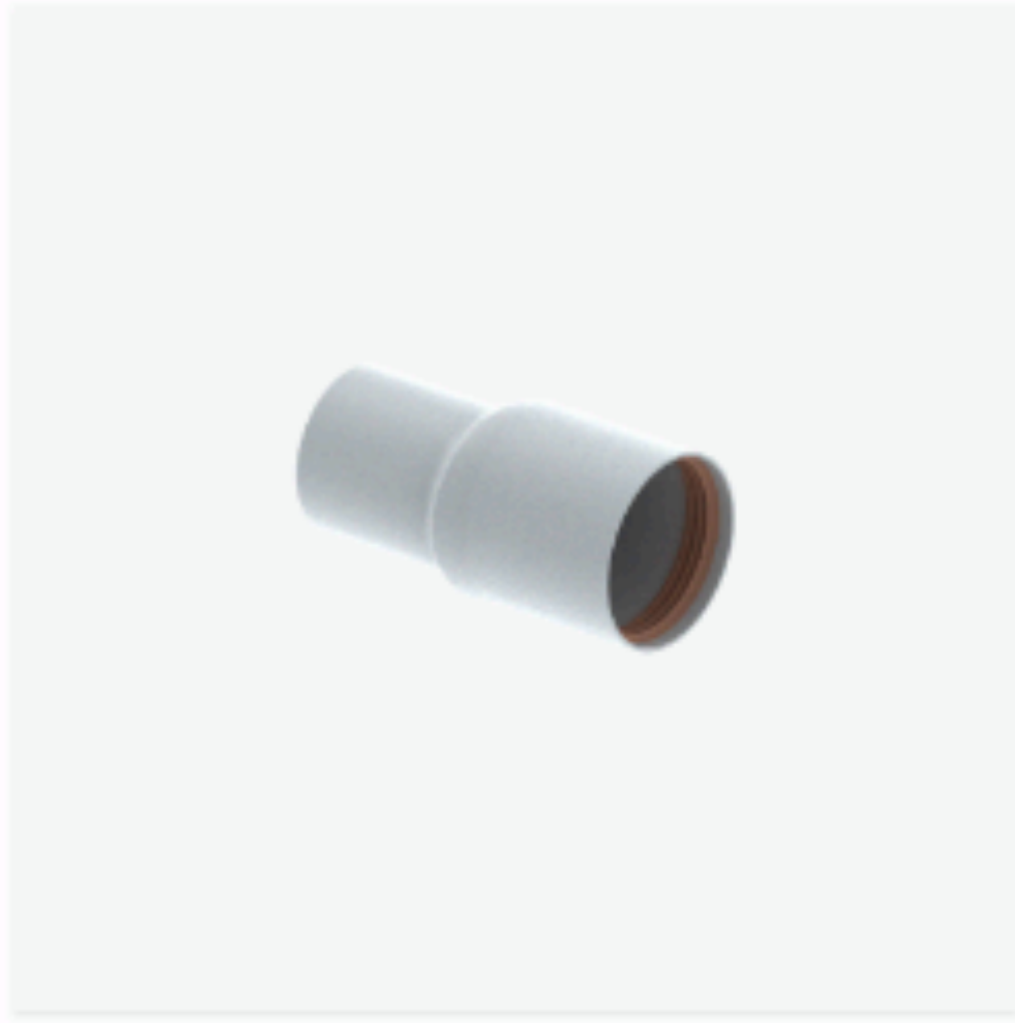

Reducer 50-40 mm



LK Drainage bend V2 complete



Ethernet connector kit



Wi-Fi antenna

Orbital Shower - Tiled Hatch Technology kit

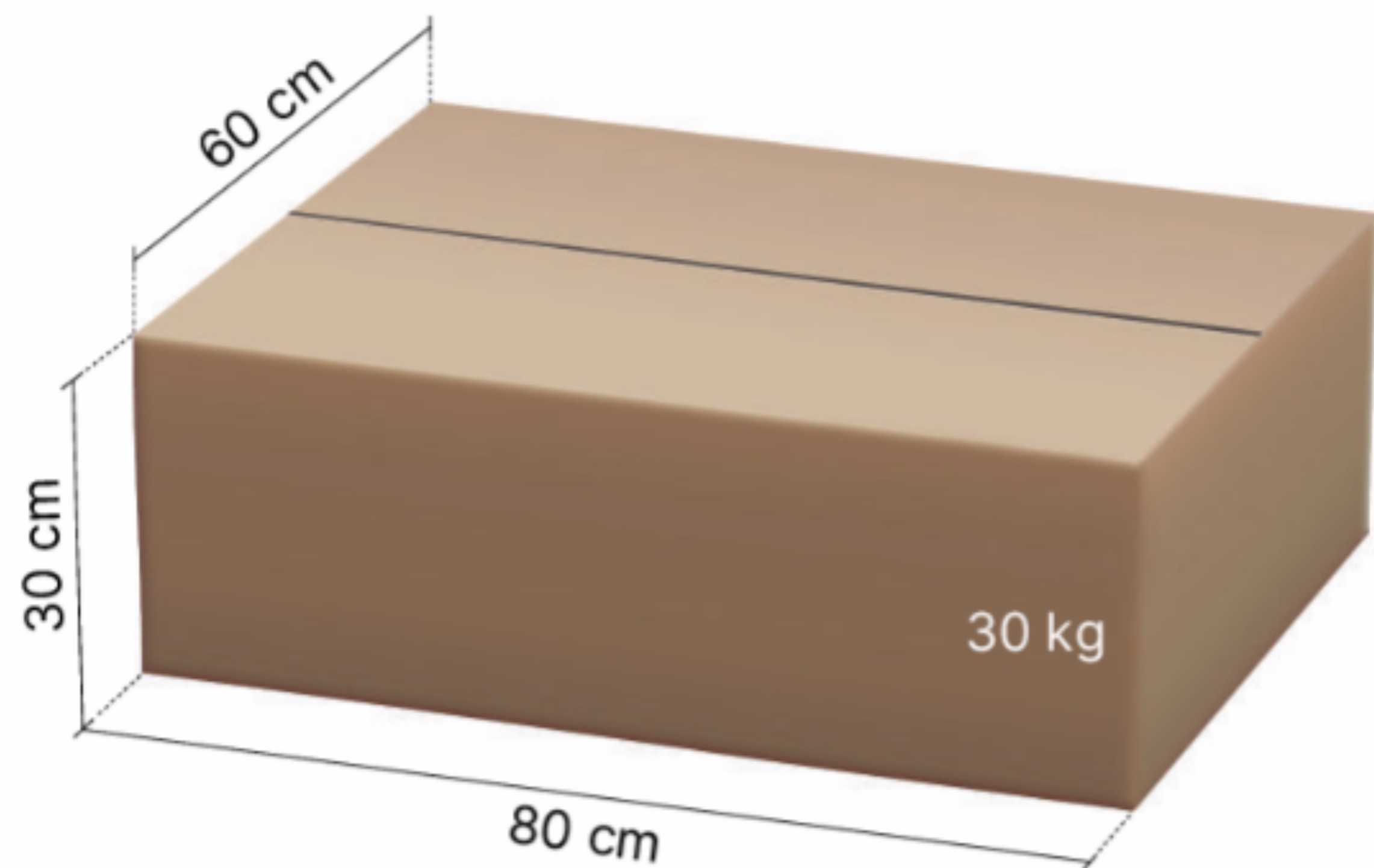

Orbital Shower Core

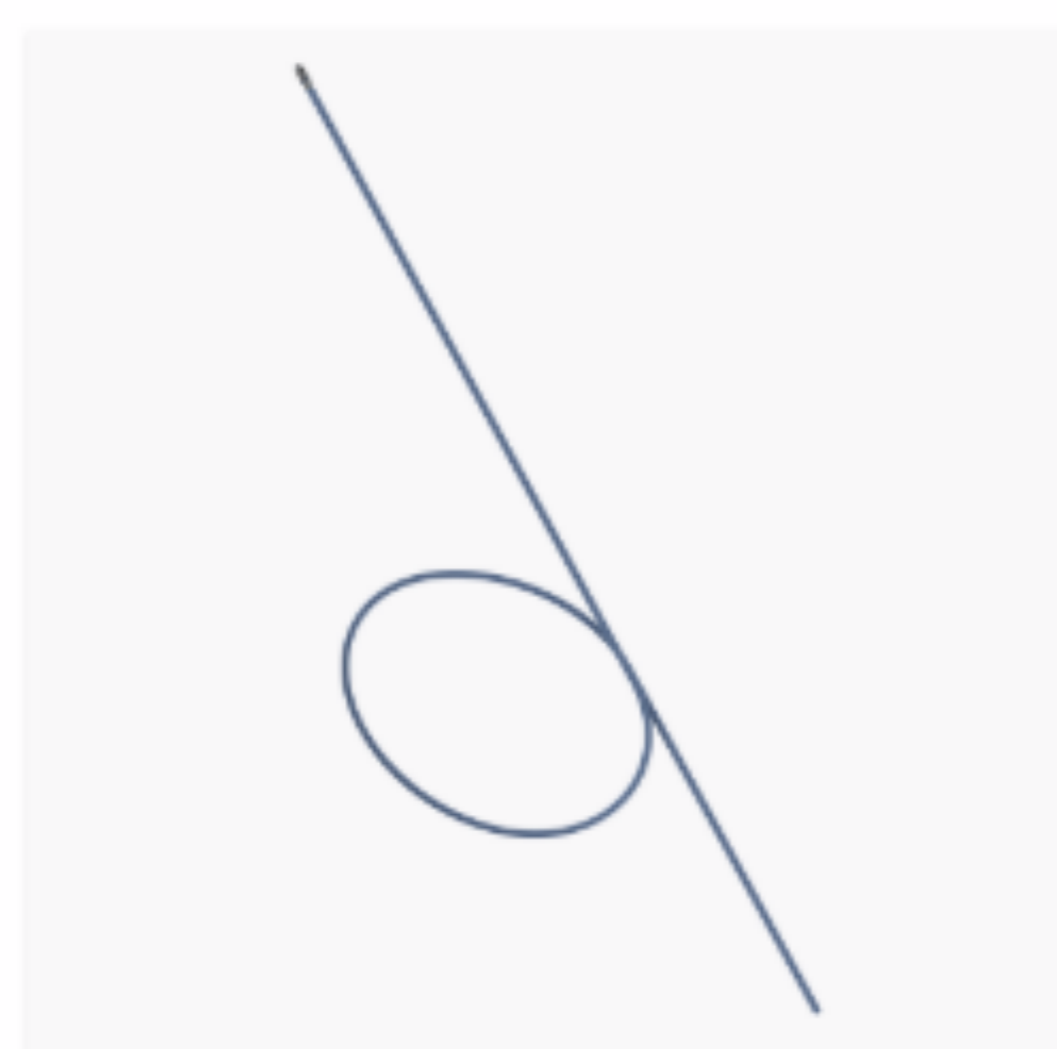

Flush hose



Recirculation hose

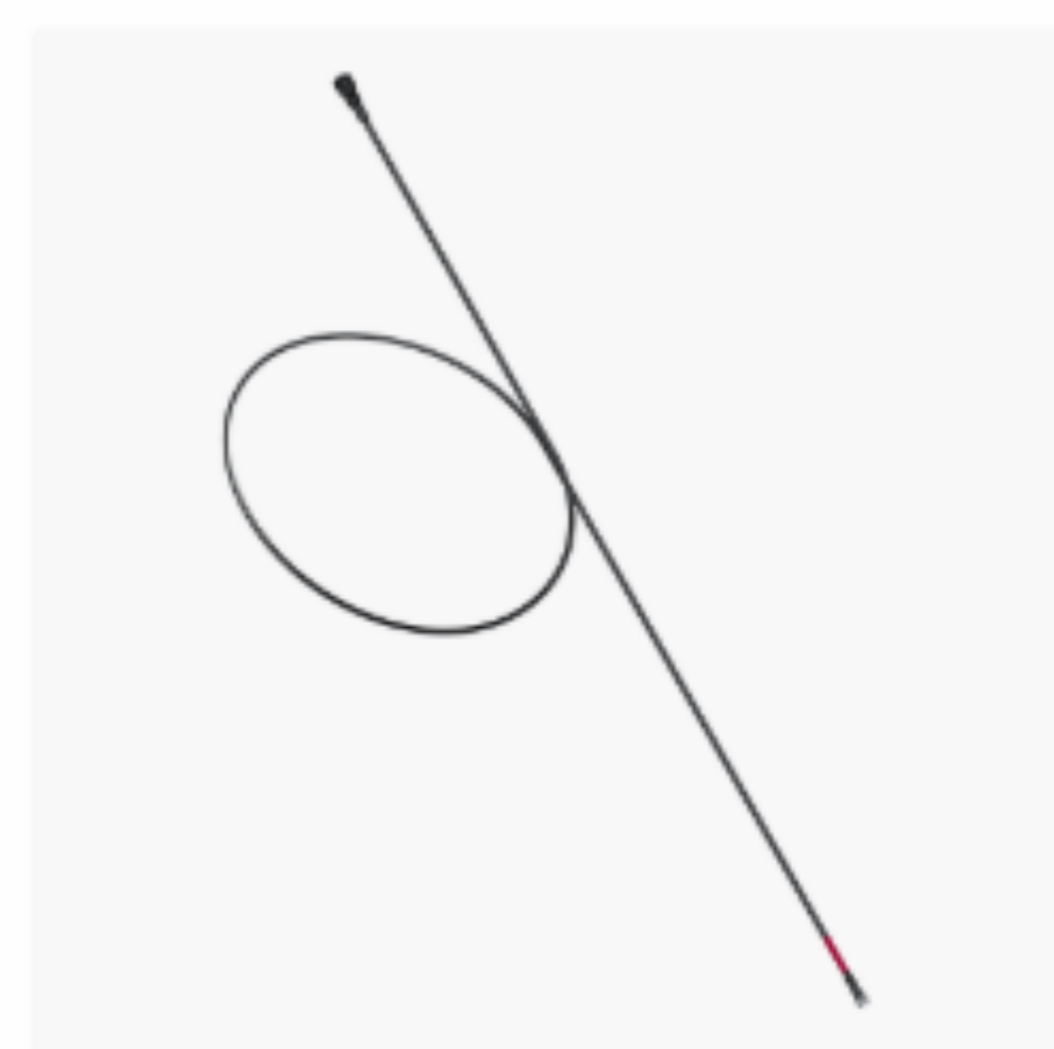

Sensor cable



Ethernet kit



Flush hose kit



Grating tool



Hose connection



Descaler tablets



Spring lock



Clip



Sensor Tank dock



Sensor Tank lock



Sensor Tank



Control Dial, including fixture, screws and extension cable



Filter capsule

Orbital Shower - Tiled Hatch Technology kit

Black or white shower heads and diverter



Hand shower with hose

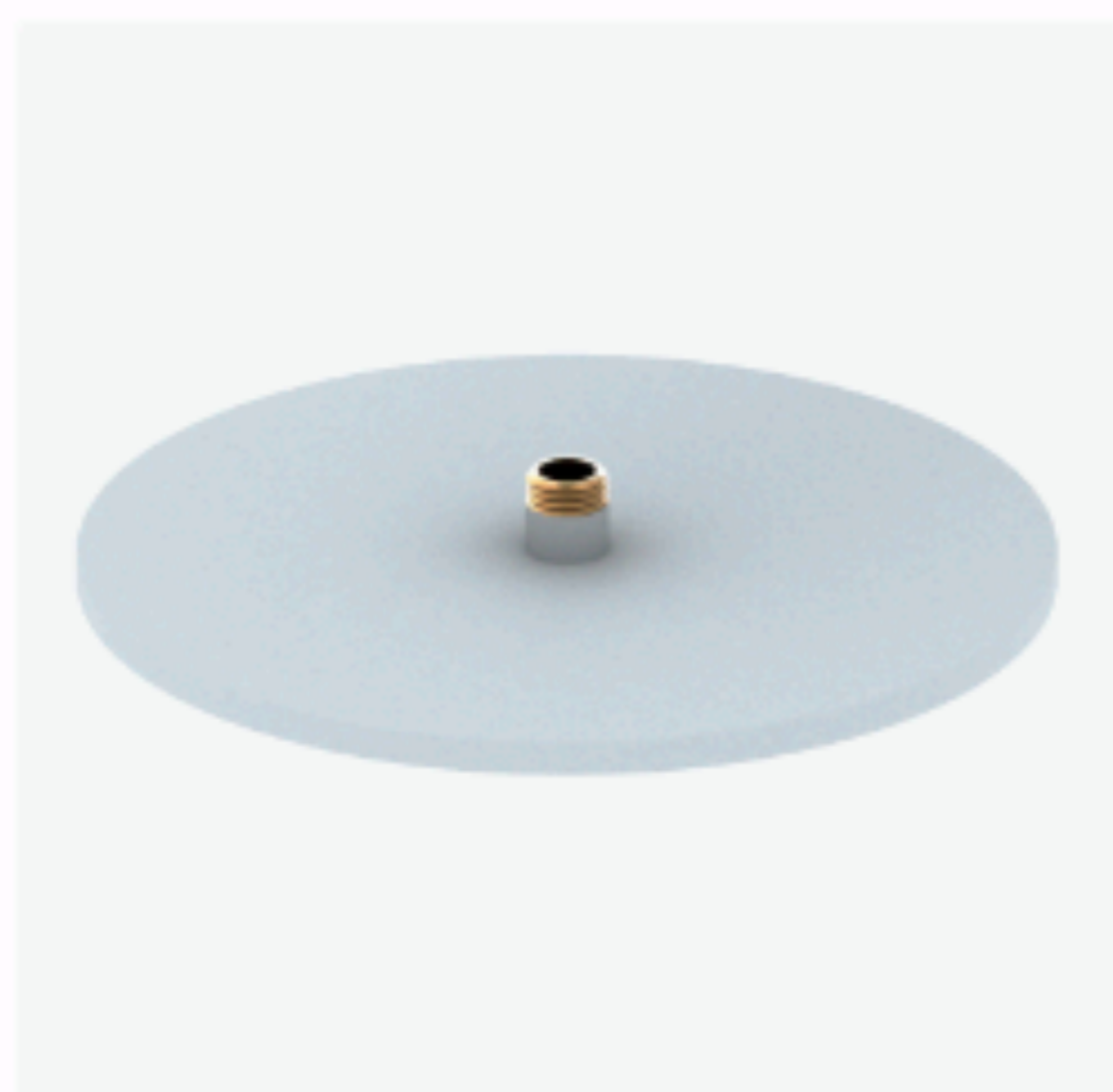

Head shower



Head shower arm



Threaded adapter



Diverter body



Diverter wall plate



Hand shower holder cover



Hand shower holder

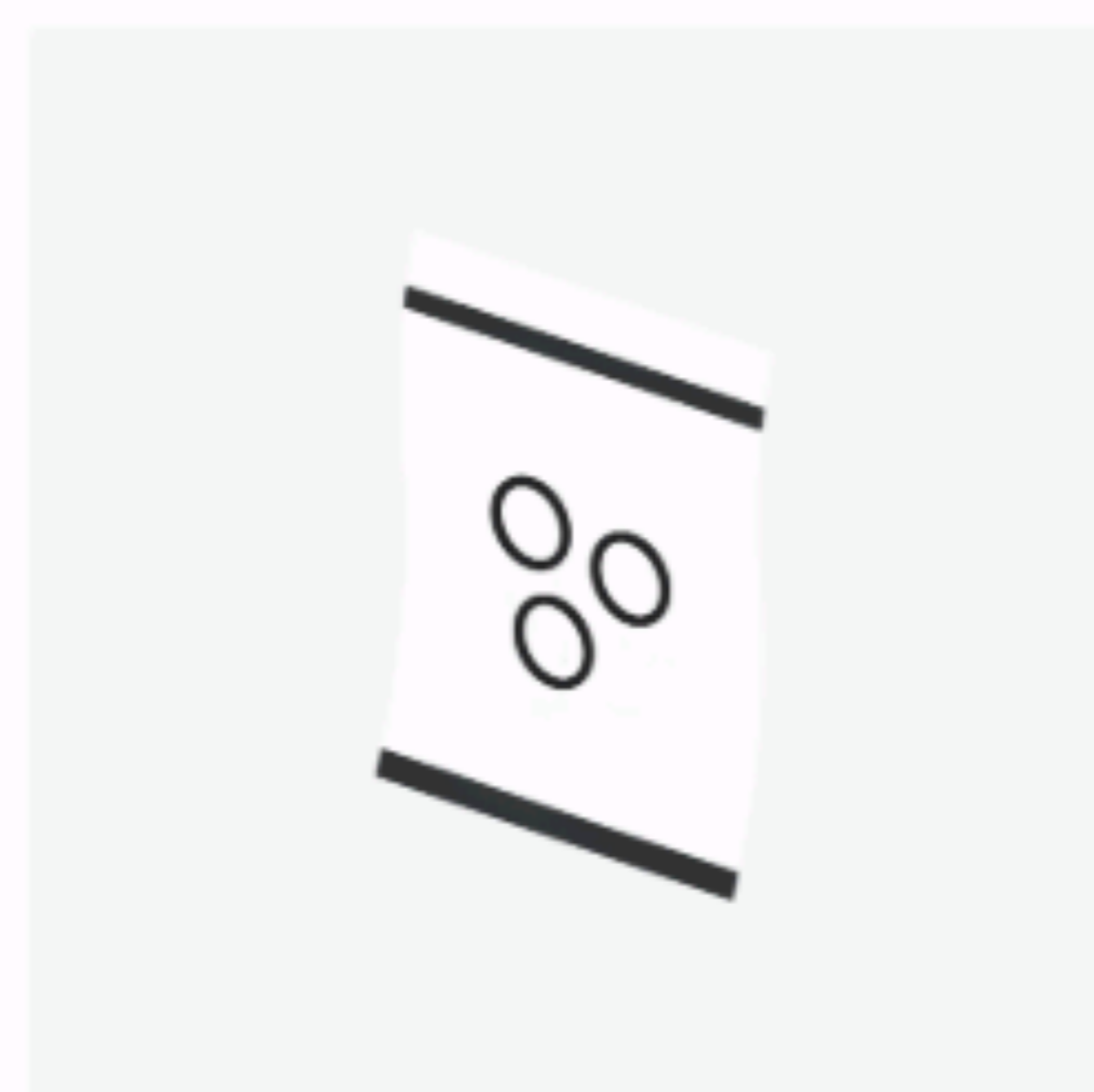

O-ring kit



Screw and tool kit