

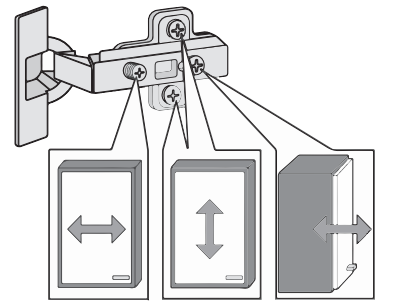

87266.530

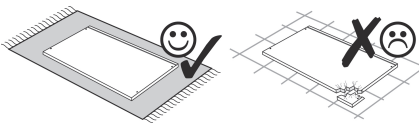

4 x 2827	4 x	8 x 30 20 x 2861	5/5 x 16 12 x 2821
3 x 1503	3 x 1611	3,5 x 15 6 x 2804	1 x
2 x	1 x 2863	10 x 2862	4 x 2552
4 x 9 2 x	5 x 30 1 x		

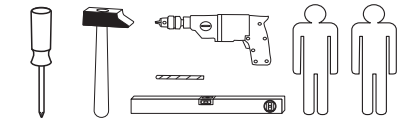
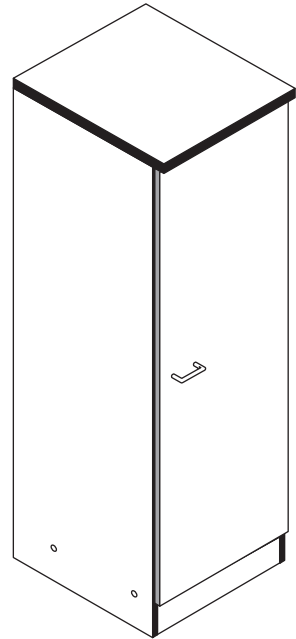
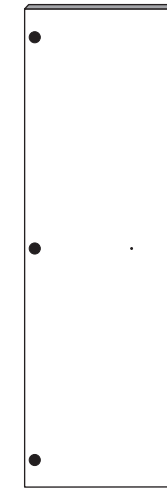
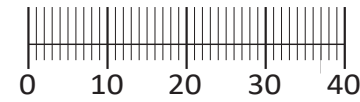

14 1 x

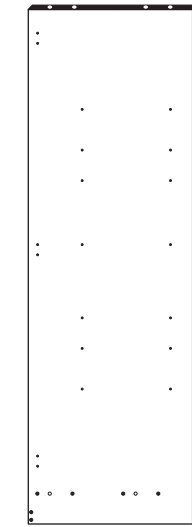

15 L 1 x

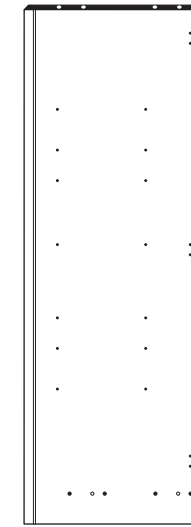

15 R 1 x



16 1 x

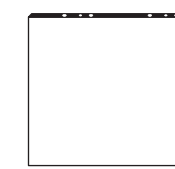

17 1 x

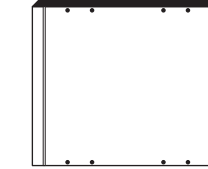

18 1 x



19 3 x

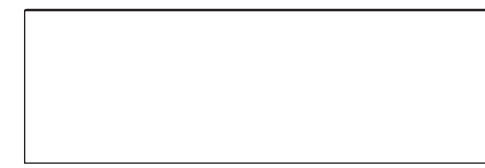

21 1 x

Das beigefügte Wandbefestigungsmaterial (Dübel und Schrauben) eignet sich nur für festes Mauerwerk (z.B.: Beton- oder Ziegelwände). Für andere Wandaufbauten sind eventuell Spezialdübel und andere Schrauben notwendig. Ziehen Sie gegebenenfalls eine Fachkraft zu Rate.

De begeleidende wandmontage hardware (pluggen en schroeven) is alleen geschikt voor massief metselwerk (bijvoorbeeld beton of bakstenen muren). Voor andere muur structuren zijn eventueel bijzondere ankerbouten en andere noodzakelijke. Draai indien nodig, een deskundige.

Приложенный материал для крепления к стене (дюбели и винты) пригоден только для жестких кладок (например, бетонные или кирпичные стены). Для других настенных конструкций необходимы смотря по обстоятельствам специальные дюбели и другие винты. При необходимости проконсультируйтесь у специалиста.

Le mur d'accompagnement matériel de montage (chevilles et les vis) ne convient que pour la maçonnerie solide (par exemple en béton ou des murs de briques). Pour les structures de mur d'autres sont peut-être spéciale boulons d'ancrage et d'autres nécessaires. Serrer le cas échéant, un expert.

Załączony materiał do mocowania do ściany (kolki rozprężne i wkręty) nadaje się tylko do ścian murowanych (np. z betonu lub cegieł). Do ścian wykonanych w innych technologiach konieczne być mogą specjalne kolki rozprężne i inne wkręty. W razie potrzeby skorzystaj z fachowej pomocy

Il muro di accompagnamento hardware di montaggio (tasselli e viti) è adatto solo per muratura piena (ad esempio calcestruzzo o muratura). Per le altre strutture murarie sono forse speciali bulloni di ancoraggio e necessari di altri. Serrare se necessario, un esperto.

The accompanying wall mounting hardware (anchors and screws) is suitable only for solid masonry (eg concrete or brick walls). For other wall structures are possibly special anchor bolts and other necessary. Tighten if necessary, an expert.

Ekteki duvara sabit montaj malzemeleri (dübel ve vidalar), sadece sağlam duvarlar için (örnek: beton veya tuğla) elverişlidir. Başka duvarlar için özel dübeller ve farklı vidalar gerekebilir. Gerektiğinde bir uzmana danışınız.

1

8 x 30 8 x 2861	5/5 x 16 12 x 2821	3 x 1611	1 x 2863
-----------------	--------------------	----------	----------

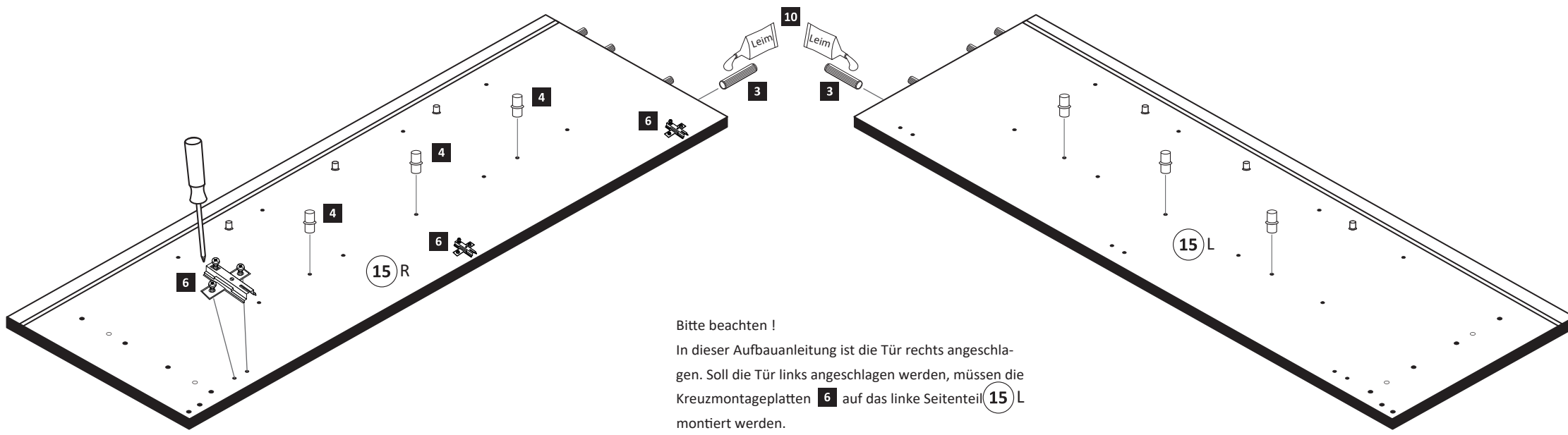
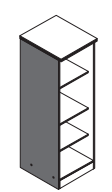
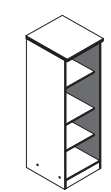

Bitte beachten !
In dieser Aufbauanleitung ist die Tür rechts angeschlagen. Soll die Tür links angeschlagen werden, müssen die Kreuzmontageplatten 6 auf das linke Seitenteil 15 L montiert werden.

2

8 x 30 12 x 2861	1 x 2863
------------------	----------

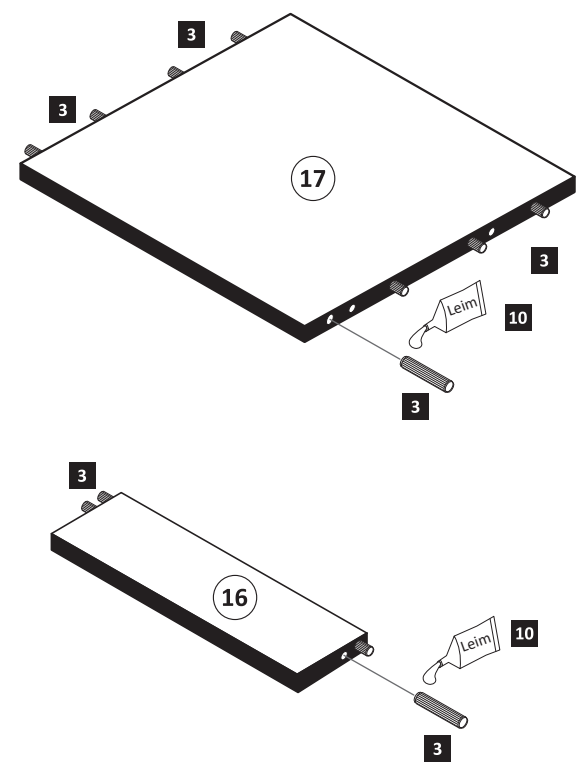
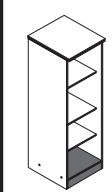

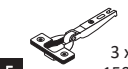
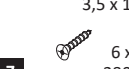

3

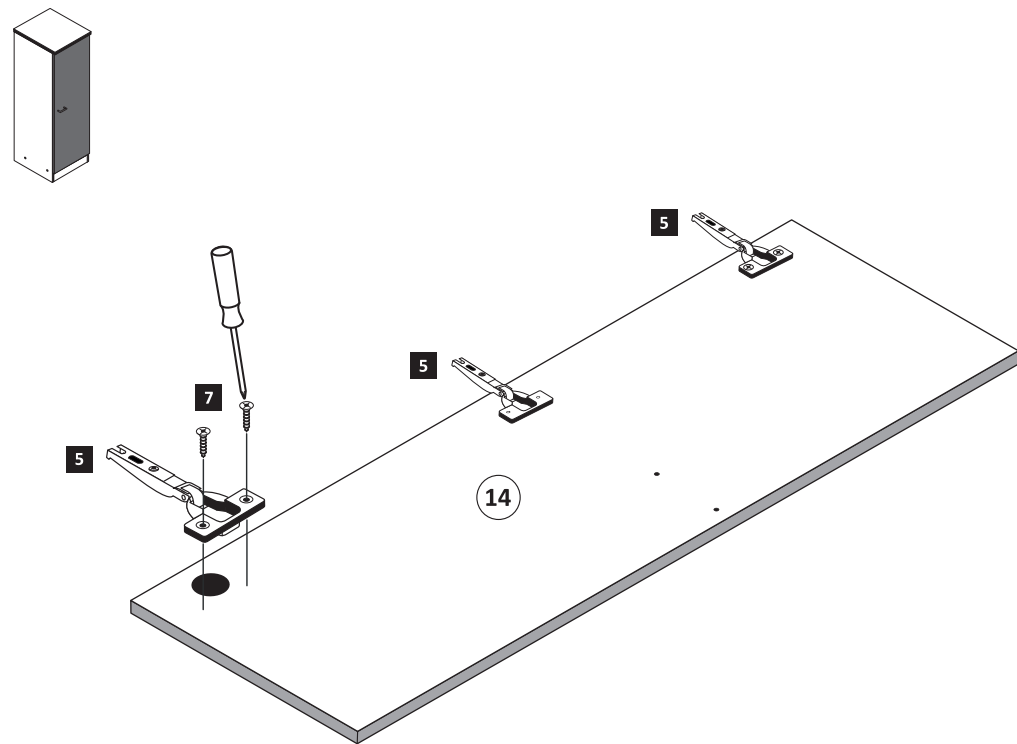
- 5  3 x 1503
- 7  6 x 2804



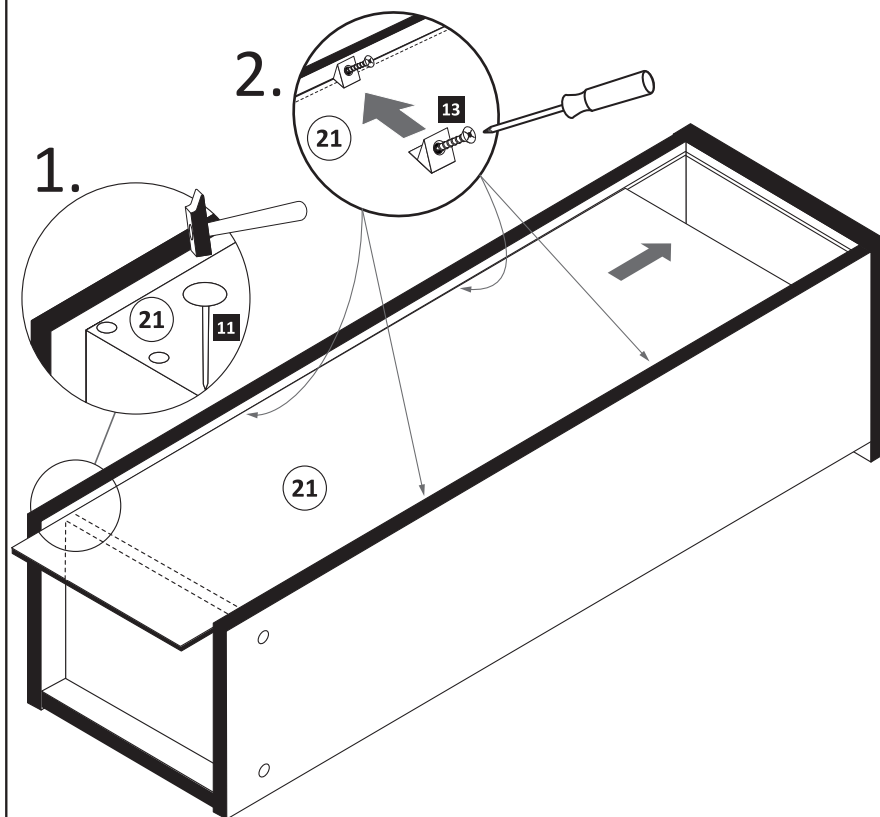

5

- 11  10 x 2862
- 13  4 x 2552



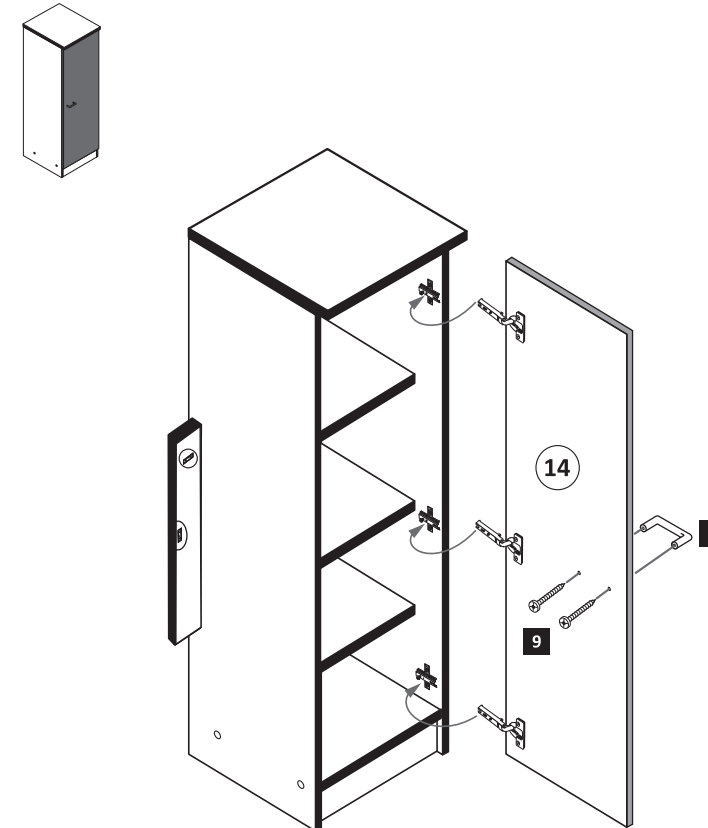

7

- 8  1 x
- 9  2 x

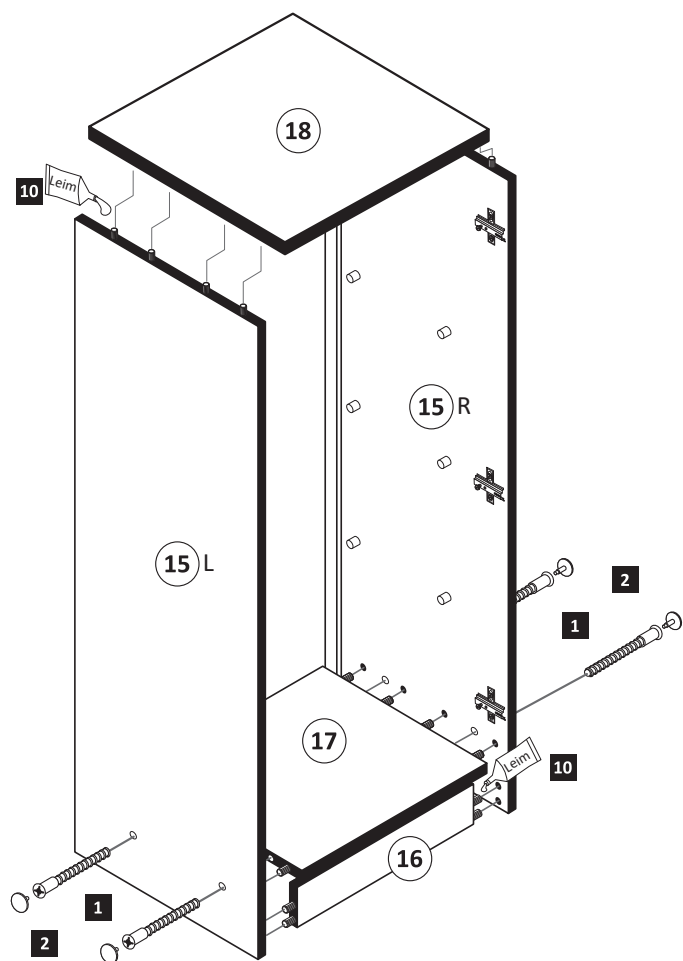

4



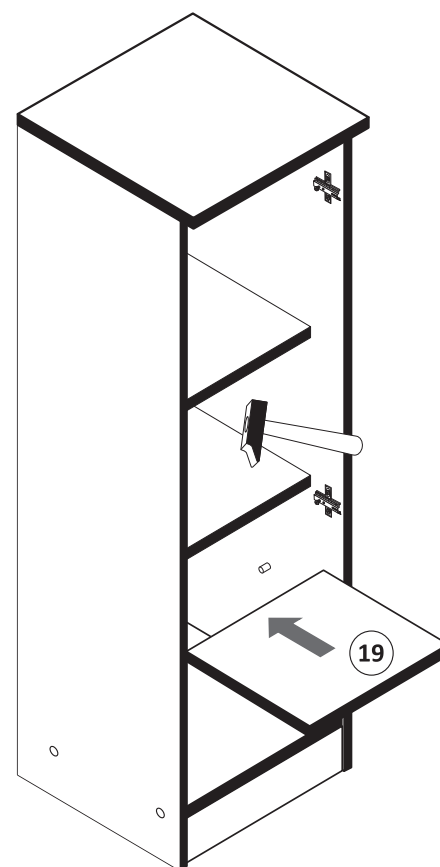
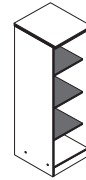

- 10  1 x 2863
- D Leim
GB Glue
NL Lijm
PL Klej
TR Tutkal
F Colle
I Colla
- 20 min.

6



8

- 22  4 x 9
- 2 x 
- 1 x  5 x 30

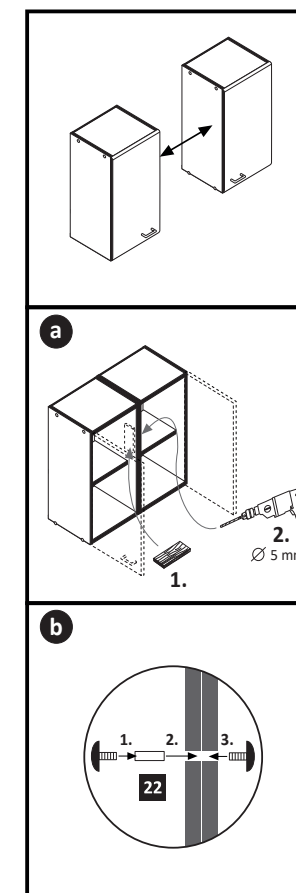

**D****Wichtige Pflegehinweise**

Bitte beachten Sie die wichtigen Pflegehinweise auf unserer Internetseite



www.till-hilft.de



Pflegehinweise

**PL****Ważne instrukcje dotyczące pielęgnacji**

Zwróć uwagę na ważną instrukcję dotyczącą pielęgnacji na naszej stronie internetowej



www.till-hilft.de



Pflegehinweise

**GB****Important care instructions**

Please note the important care instructions on our website



www.till-hilft.de



Pflegehinweise

**SK****Dôležité pokyny na starostlivosť**

Dbajte na dôležité pokyny týkajúce sa starostlivosti na našich webových stránkach



www.till-hilft.de



Pflegehinweise

**FR****Instructions d'entretien importantes**

S'il vous plaît noter les instructions de soins importants sur notre site Web



www.till-hilft.de



Pflegehinweise

**HU****Fontos kezelési utasítások**

Kérjük, vegye figyelembe a honlapunkon található fontos kezelési útmutatót



www.till-hilft.de



Pflegehinweise

**IT****Importanti istruzioni per la cura**

Si prega di notare le importanti istruzioni per la cura sul nostro sito web



www.till-hilft.de



Pflegehinweise

**RO****Instrucțiunile importante de îngrijire**

Rețineți instrucțiunile importante de îngrijire de pe site-ul nostru



www.till-hilft.de



Pflegehinweise

**NL****Belangrijke zorginstructies**

Let op de belangrijke zorginstructies op onze website



www.till-hilft.de



Pflegehinweise

**TR****Önemli bakım talimatları**

Lütfen web sitemizdeki önemli bakım talimatlarını dikkate alınız



www.till-hilft.de



Pflegehinweise

**CZ****Důležité pokyny pro péči**

Vezměte prosím na vědomí důležité pokyny pro péči na našich webových stránkách



www.till-hilft.de



Pflegehinweise

**RU****Важные инструкции по уходу**

Обратите внимание на важные инструкции по уходу на нашем веб-сайте



www.till-hilft.de



Pflegehinweise



www.till-hilft.de



89930.330

 4 x 1980	 3,5 x 15 16 x 2804	 8mm 4 x 2917
---	--	--



!! WICHTIG!!

Bitte fixieren den Schrank an der Wand bzw. an dem Nachbarschrank erst nach dem die Höheneinstellung mit dem Füßen durchgeführt ist.

