



SPACY

SPACY

SPACY

SPACY205 | 84 x 205 cm

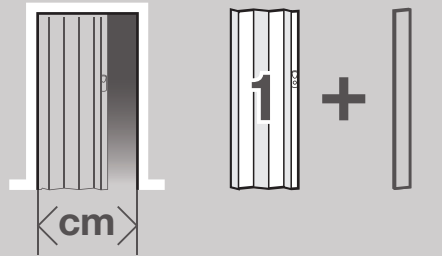

84	-
99	1
113	2
128	3
142	4

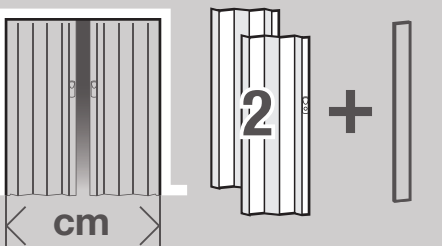

168	-
183	1
197	2
212	3
226	4
241	5
255	6
270	7
284	8

ÉMISSIONS DANS L'AIR INTÉRIEUR*

A+

*Information sur le niveau d'émission de substances volatiles dans l'air intérieur, présentant un risque de toxicité par inhalation, sur une échelle de classe allant de A+ (les faibles émissions) à C (fortes émissions).

Rb **Lea** **100%**

GARANTIE GARANTÉE

2

ANS/YEARS

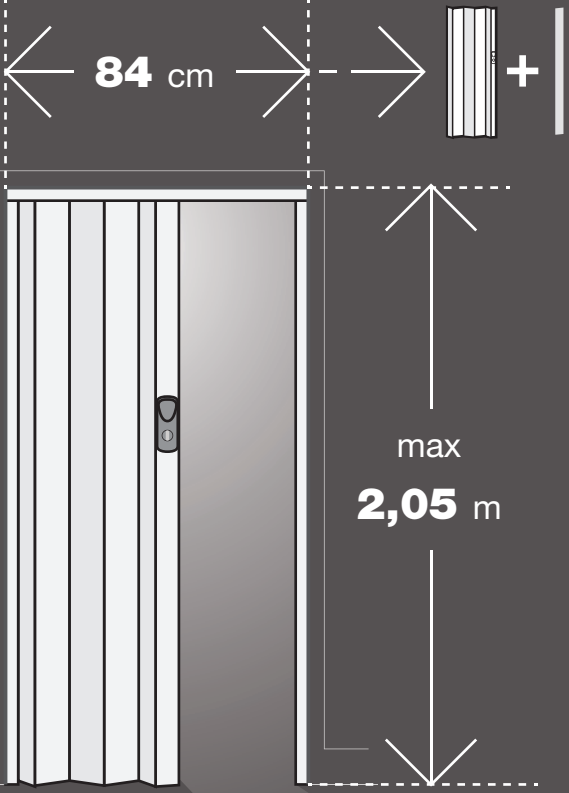

Réf. 4099205



SPACY205 | 84 x 205 cm



SPACY

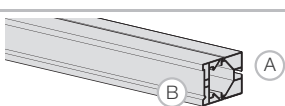

FR A Accrochage / B Réception
 DE A Aufnahme- / B Befestigungsschiene
 NL A Ophangrail- / B Bevestigingsrail
 ES A fijación / B cierre
 IT A Aggancio / B Ricezione
 PT A Perfil de engate / B e de fecho
 EN A Fixing / B Reception section

x1

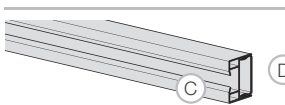

FR C rail / D support
 DE C Führungsschiene / D Halterung
 NL C Geleidsrail / D Houder
 ES C guía / D soporte
 IT C guida di scorrimento / D supporto
 PT C guia / D suspensão
 EN C rail / D support

x1

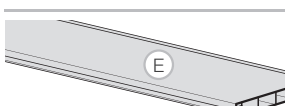

FR Demi-lame 2 jons
 DE Halblamelle 2 Lippen
 NL Half profiel 2 geleiders
 ES Media lámina reversible
 IT Semi-pannello 2 bordi
 PT Meia lâmina reversível
 EN Half-panel 2 leaves

x1

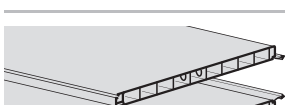

x2

x2

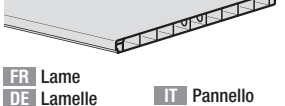

FR Lamelle
 DE Lamelle
 NL Profiel
 ES Lámina

IT Pannello
 PT Lámina
 EN Leaf

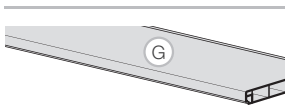

FR Demi-lame 1 jonc
 DE Halblamelle 1 Lippe
 NL Half profiel 1 geleider
 ES Media lámina fija
 IT Semi-pannello 1 bordo
 PT Meia lâmina fixa
 EN Half-panel 1 leaf

x1

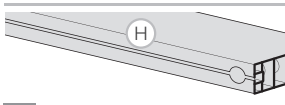

FR Lame fermeture
 DE Schließprofil
 NL Sluiprofiel
 ES Lámina de cierre

IT Pannello di chiusura
 PT Lámina de fecho
 EN Closing leaf

x1

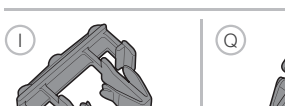

x1

x4



x2

x5

x1



Ø 4.3 mm
 L 45 mm x4

Ø 4 mm
 L 30 mm x15



x1

L16mm x2

x1

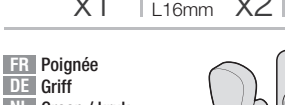

FR Poignée
 DE Griff
 NL Greep / kruk
 ES Manetas / cerradura
 IT Maniglia
 PT Maçaneta
 EN Handle

x2

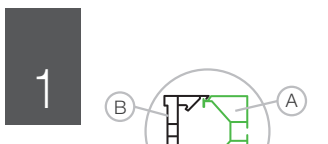
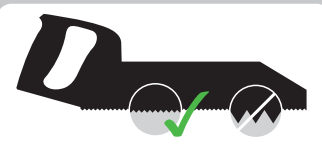
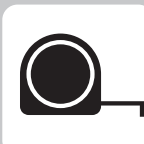

1
 FR Séparer accrochage et réception
 DE Trennen Sie Aufnahme- und Befestigungsschiene
 NL Scheid de ophangrail en de bevestigingsrail
 ES Separar el perfil lateral de fijación del perfil lateral de cierre
 IT Separare aggancio e ricezione
 PT Separar o perfil lateral de engate e o perfil lateral de fecho
 EN Separate the fixing and receiving sections



2
 FR Recouper la réception, l'accrochage et les lames selon la hauteur de l'encadrement
 DE Kürzen Sie Aufnahme-, efestigungsschiene und Lamellen auf Höhe des Rahmens
 NL Kort de ophangrail, bevestigingsrail en profielen in op lengte van het kozijn
 ES Cortar a la medida el perfil y lateral según la altura de la puerta o marco
 IT Ritagliare la ricezione, l'aggancio ed i pannelli in base all'altezza del vano
 PT Cortar à medida o perfil de fecho e engate lateral segundo a altura de enquadramento da porta
 EN Cut the receiving and fixing profiles and the leaves to the frame height

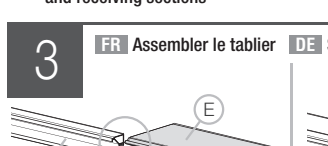
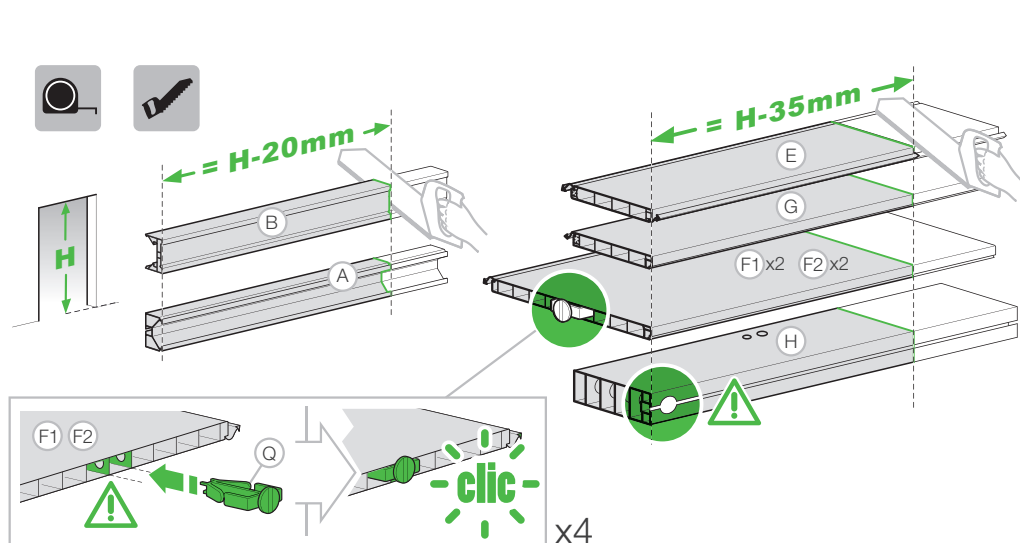

3
 FR Assembler le tablier
 DE Stecken Sie die Lamellen zusammen
 NL Verbind de profielen
 ES Ensambler las láminas entre sí
 IT Assemblare l'anta mobile
 PT Unir as lâminas
 EN Assemble the panels

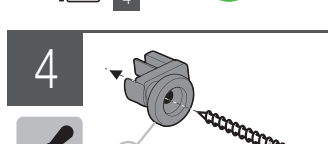

4
 FR Visser les patins côté accrochage
 DE Schrauben Sie die Halter an Aufnahmeschiene
 NL Schroef de houder op ophangrailrail
 ES Atornillar los patines del lado de la fijación
 IT Avvitare i pattini dal lato aggancio
 PT Aparafusar a patilha à meia lâmina de engate
 EN Screw the rollers on the fixing face

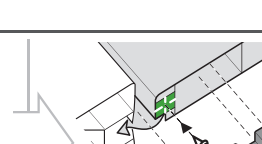

5
 FR Visser les patins côté réception
 DE Schrauben Sie die Halter an die Befestigungsschiene
 NL Schroef de houder op bevestigingsrail
 ES Atornillar patin del lado de la recepción
 IT Avvitare i pattini dal lato ricezione
 PT Aparafusar a patilha à meia lâmina de fecho
 EN Screw the rollers on the receiving face



6
 FR Clipper l'embout sur la lame fermeture
 DE Klippen Sie den Anschluss in das Schließprofil
 NL Klip de beugel in het sluitprofiel
 ES Clipar el soporte guía sobre la lámina de cierre
 IT Agganciare la punta sul pannello di chiusura
 PT Introduzir a peça de encaixe na lâmina de fecho
 EN Clip the end cap on closing leaf

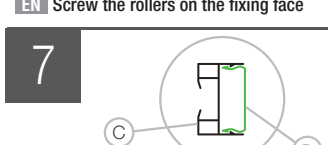

7
 FR Séparer rail et support
 DE Trennen Sie Führungsschiene und Halterung auf Breite des Rahmens
 NL Scheid geleidsrail en houder
 ES Separar la guía del soporte de fijación
 IT Separare la guida di scorrimento ed il supporto
 PT Separar a guia e o suporte de fixação
 EN Separate the rail and support

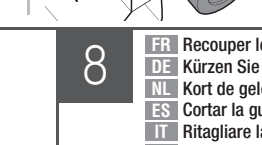

8
 FR Recouper le rail et le support selon la largeur de l'encadrement
 DE Kürzen Sie Führungsschiene und Halterung auf Breite des Rahmens
 NL Kort de geleidsrail en houder in op breedte van het kozijn
 ES Cortar la guía superior y el soporte según el ancho de la apertura
 IT Ritagliare la guida di scorrimento in base alla lunghezza del vano
 PT Cortar a guia superior e o suporte segundo a largura do enquadramento
 EN Cut the rail and support to fit the door frame

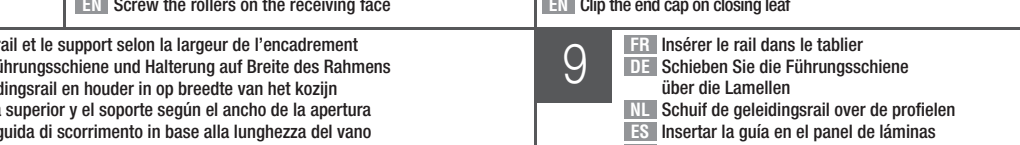

9
 FR Insérer le rail dans le tablier
 DE Schieben Sie die Führungsschiene über die Lamellen
 NL Schuif de geleidsrail over de profielen
 ES Insertar la guía en el panel de láminas
 IT Inserire la guida di scorrimento nell'anta mobile
 PT Inserir a guia no painel de lâminas
 EN Slide the rail into the panels



10
 FR Fixer le support du rail dans l'encadrement
 DE Befestigen Sie die Halterung am Rahmen
 NL Bevestig de houder op het kozijn
 ES Fijar el soporte de la guía al marco
 IT Fissare il supporto della guida di scorrimento nel vano
 PT Fixar o suporte das guias no enquadramento
 EN Fix the slideway to the frame



FR Clipper le rail et le tablier dans le support
 DE Klippen Sie die Führungsschiene mit Lamellen in die Halterung
 NL Klik de geleidsrail met profielen in de houder
 ES Clipar la guía y las láminas en el soporte
 IT Agganciare la guida di scorrimento e l'anta mobile nel supporto
 PT Introduzir a guia e as lâminas no suporte
 EN Clip the rail and panels in the slideway



11
 FR Fixer les clips d'accrochage au mur
 DE Fixieren Sie die Clips für das Befestigungsprofil
 NL Bevestig de bevestigingsclips op de wand
 ES Fijar los accesorios de montaje a la pared
 IT Fissare il clip di aggancio al muro
 PT Fixar os clips de encaixe à parede
 EN Install the fixing clips on the wall

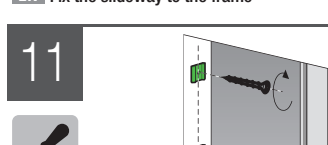

FR Clipper la porte au mur
 DE Klippen Sie die Tür an der Wand fest
 NL Kip de deur aan de wand
 ES Clipar el perfil de fijación a la pared
 IT Agganciare la porta al muro
 PT Encaixar a porta no paredeco
 EN Clip the door to the wall



12
 FR Installer la poignée
 DE Bringen Sie den Griff an
 NL Installeer de greep/kruk
 ES Montar la maneta



13
 FR Fixer le profilé de réception au mur
 DE Befestigen Sie das Aufnahmeprofil an der Wand
 NL Bevestig het ophangprofiel aan de wand
 ES Fijar el perfil de cierre a la pared
 IT Fissare il profilato di ricezione al muro
 PT Fixar o perfil de fecho à parede
 EN Fix the receiving profile to the wall

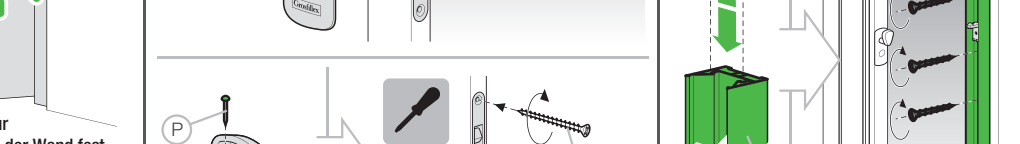

14
 FR Fixer la gâche
 DE Bringen Sie den Beschlag an
 NL Bevestig de slotplaat
 ES Fijar el cierre de la maneta



15
 IT Fissare la bocchetta
 PT Instalar a chapa-testa
 EN Fit the strike plate

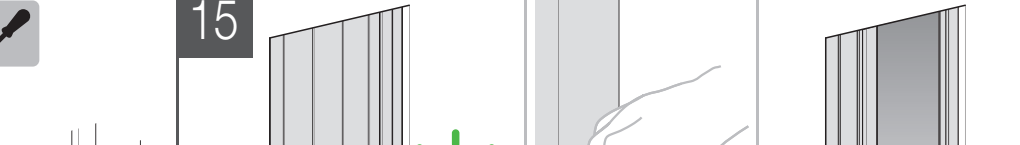

+
 FR Double cloison
 DE Trennwand
 NL Dubbele wand
 ES Doble tabique
 IT Doppio tramezzo
 PT Divisória dupla
 EN Double folding door

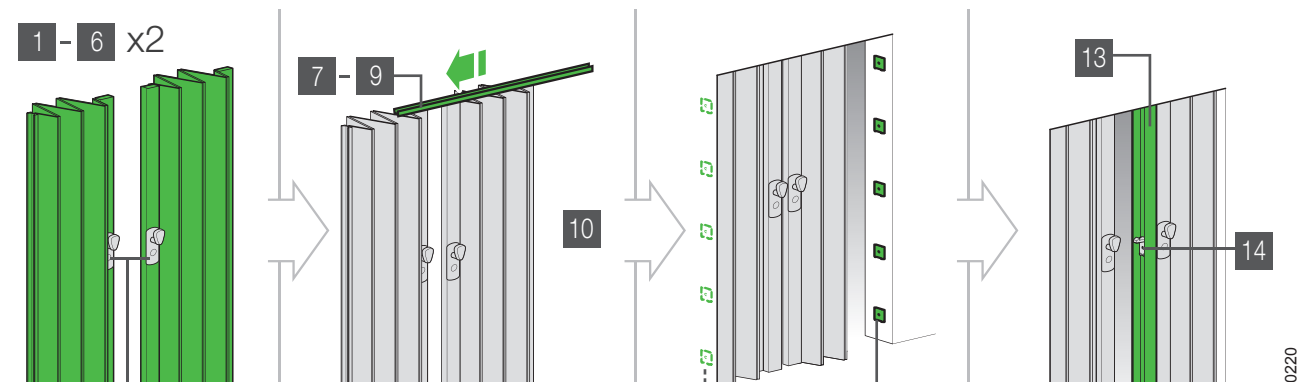

Grosfillex

Réf. 4099205
 Grosfillex Société par Actions Simplifiées
 Capital de 408 000 Euros
 RC Bourg-en-Bresse 759 201 106
 Rue de Lac
 CS60401 Arbenat
 01117 Oyonnax Cedex - France