

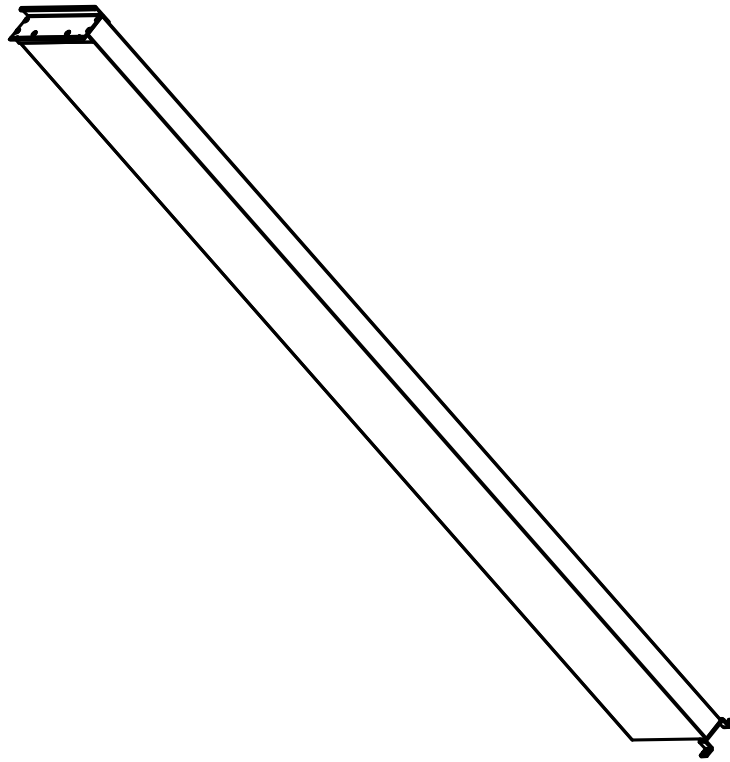

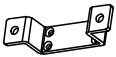



ZT199  
ZT200

e-mail: [customerservice@sorara.eu](mailto:customerservice@sorara.eu)

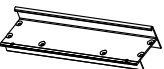

**MIDDLE PANEL**  
FILLER PANEL

REF	PARTS	QTY	SPECS
A		2	
B		4	ST5. 5X50
C		4	8X40
D		5	ST4. 8X25
E		15	ST4. 2X25
F		1	
G		1	
H		1	

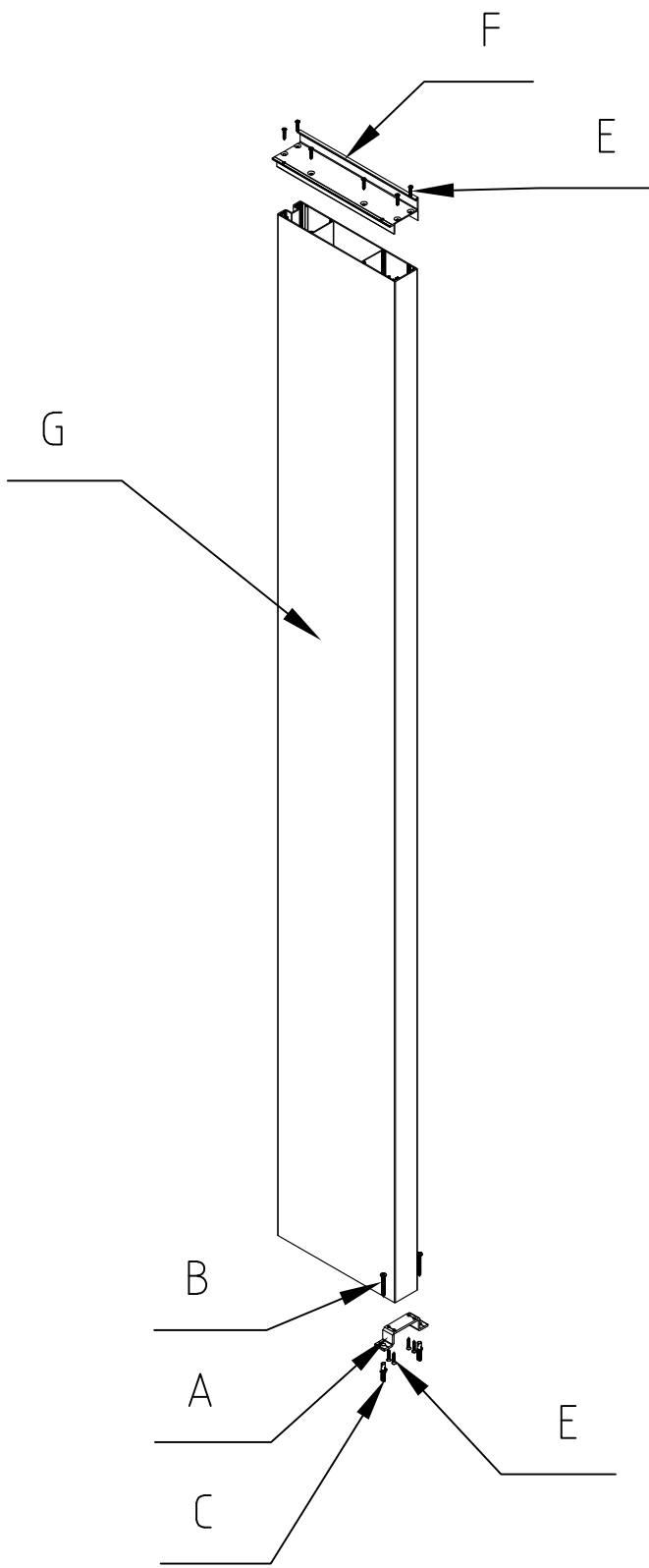

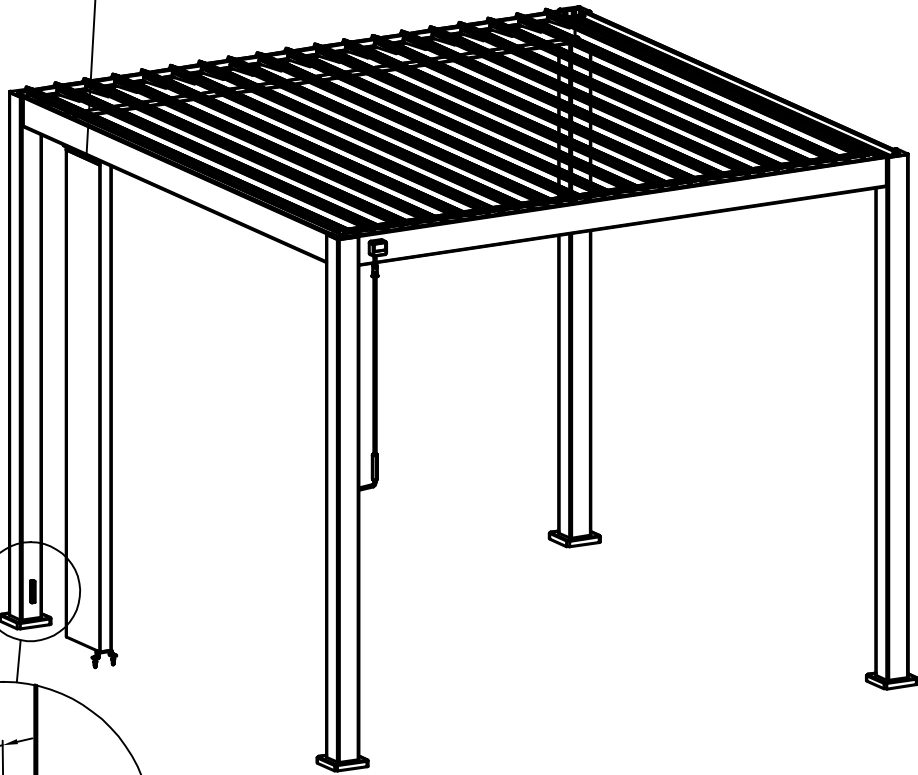
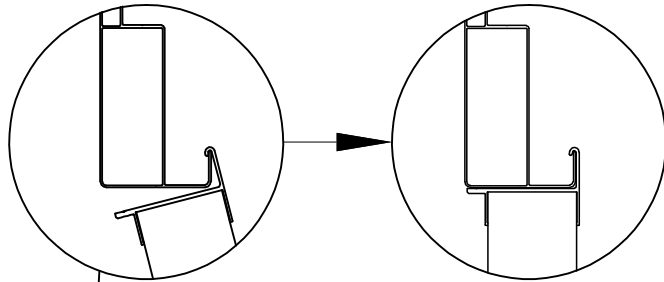

D,H

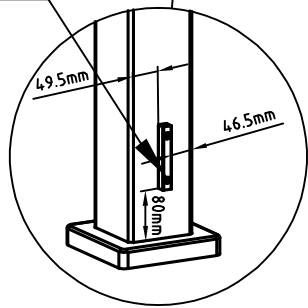

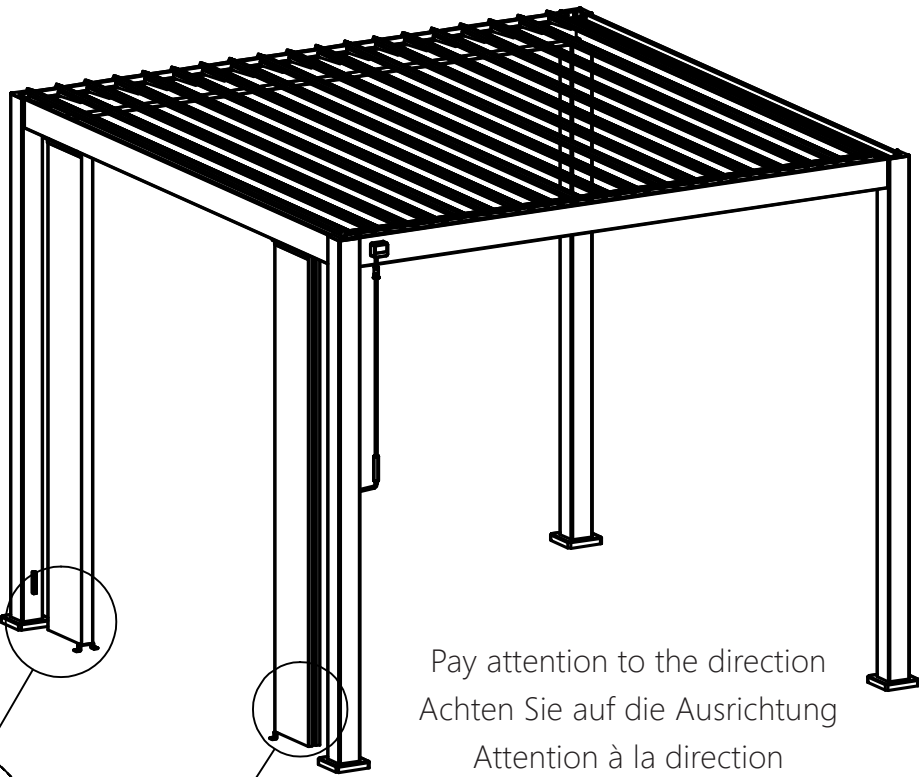

Pay attention to the direction  
Achten Sie auf die Ausrichtung  
Attention à la direction  
Prestare attenzione alla direzione  
Figyeljen az irányra  
Let op de richting

