

PERGOLA MIT LAMELLENDACH DL 3X4 M

PERGOLA WITH LOUVERED ROOF DL 3X4 M

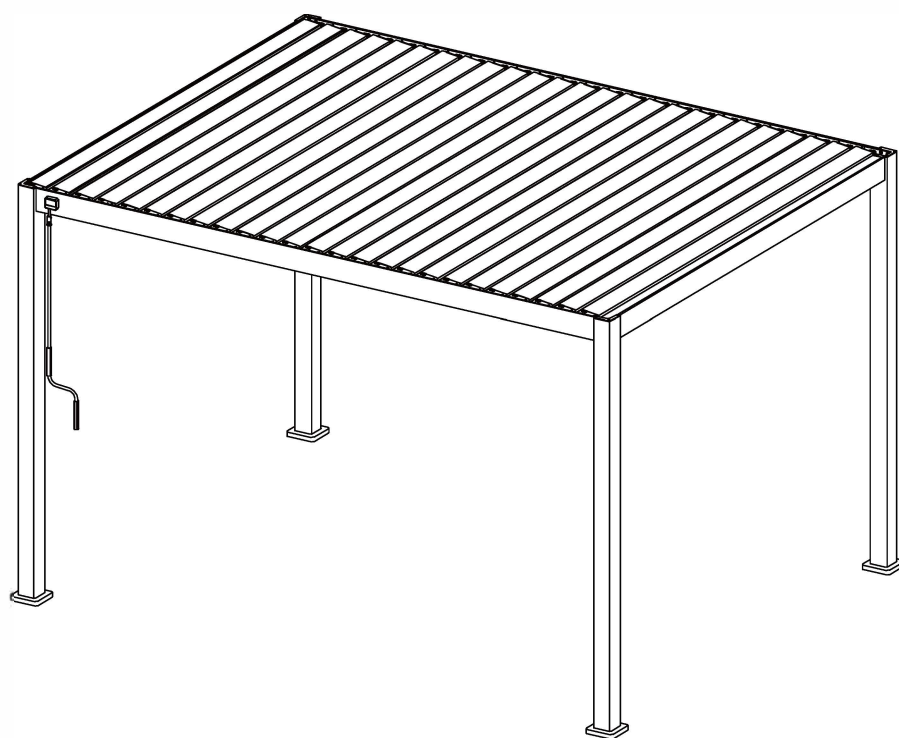

GB | PERGOLA AWNING | Installation and User Manual
DE | PERGOLA MARKISE | Montage- und Gebrauchsanweisung
FR | STORE PERGOLA | Manuel d'installation et de l'utilisateur
IT | TENDA PERGOLA | Manuale d'installazione e d'uso
HU | PERGOLA AWNING | Telepítési és használati útmutató
NL | PERGOLA MET LAMELLENDAK | Installatie- en gebruikershandleiding





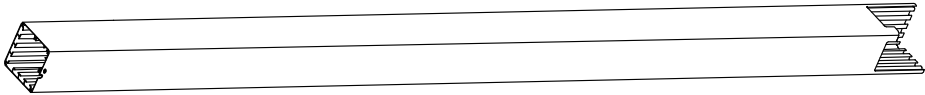
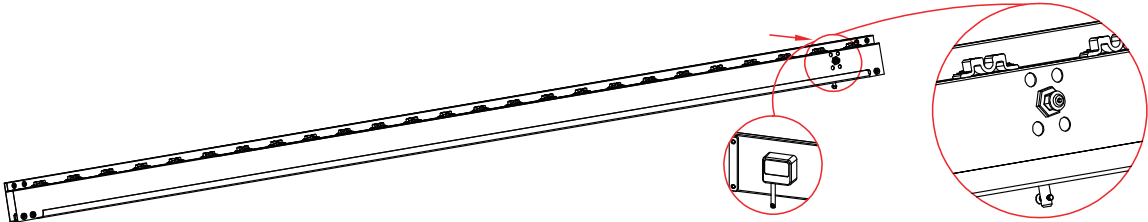
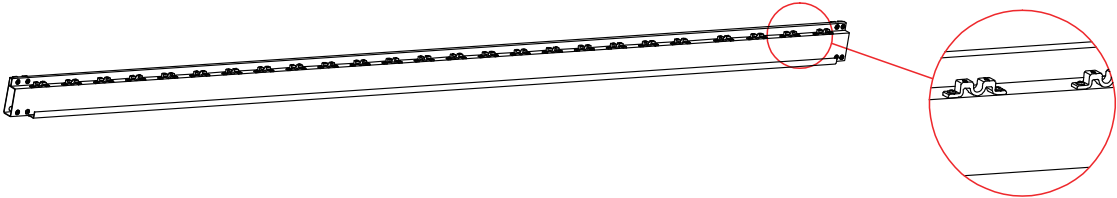
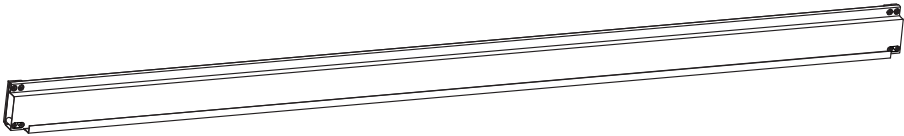
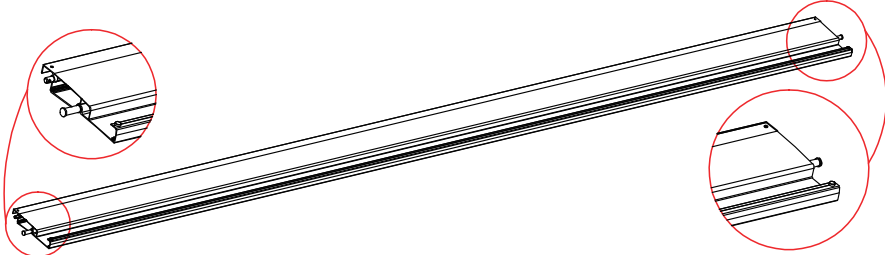
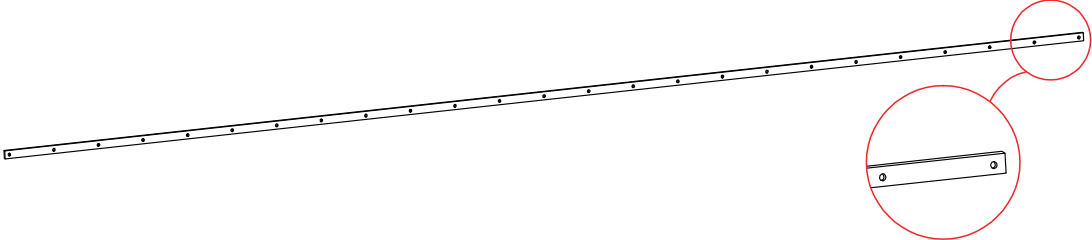

Installation Video

e-mail: customerservice@sorara.eu

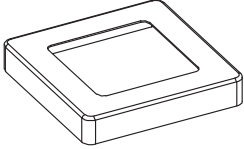
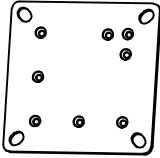
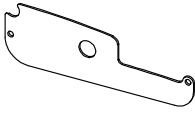
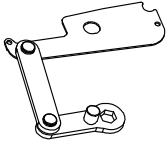
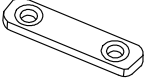
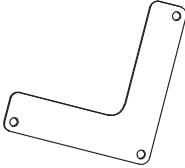
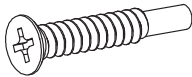
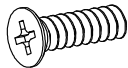
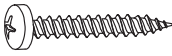
	REF	QTY	REF	QTY	REF	QTY
Carton 1/4	(A)	4PCS	(I)	4PCS	(J)	4PCS
	(K)	51PCS	(L)	1PC	(M)	52PCS
	(N)	4PCS	(O)	24PCS	(P)	104PCS
	(Q)	104PCS	(R)	12PCS	(S)	29PCS
	(V)	1PC	(W)	16PCS	(X)	1PC
	(Y)	2PCS	(Z)	1PC		
	User Manual	1SET				
Carton 2/4	(B1)	1PC	(B2)	1PC	(C)	2PCS
	(G)	1PC	(H)	1PC		
Carton 3/4	(D)	13PCS				
Carton 4/4	(D)	12PCS				

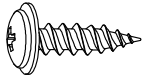
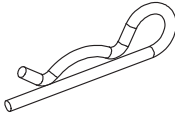
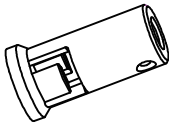
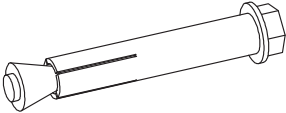
REF	PICTURE	QTY
A		4PCS
B1		1PC
B2		1PC
C		2PCS
D		25PCS
G		1PC
H		1PC

REF	PICTURE	QTY
I		4PCS
J		4PCS
K		51PCS
L		1PC
M		52PCS
N		4PCS
O		24PCS
P	 M5x12mm	104PCS
Q	 4.2x25mm	104PCS

REF	PICTURE	QTY
R	 5.5x19mm	12PCS
S		29PCS
V		1PC
W		16PCS
X		1PC
Y		2PCS
Z	 Ø12mm	1PC

GB - WARNING

- Read these installation and use instructions carefully before installing and using the pergola.
- Observe the installation requirements and methods for proper and safe installation of the Pergola.

Instructions for use

This pergola is suitable for outdoor use and protects against direct sun or glare.

In case of strong wind (Beaufort wind force over 3 = more than 19 km/h) or forecasts of snowfall, please set the slats vertically (open). The closed slats are not designed to carry snow and ice loads. The pergola is not intended for commercial use.

DE - WARNUNG

- Vor Montage und Verwendung der Pergola-Markise diese Montage- und Gebrauchsanleitung sorgfältig durchlesen.
- Die Montageanforderungen und -methoden für eine fachgerechte und sichere Montage der Pergola-Markise beachten

Verwendungshinweis

Diese Pergola-Markise ist für den Einsatz im Außenbereich geeignet und schützt vor direkter Sonne oder Blendung.

Bei Aufkommen von starkem Wind (Beaufort-Windstärke über 3 = mehr als 19 km/h) oder Vorhersagen von Schneefall bitte die Lamellen senkrecht stellen (öffnen). Die geschlossenen Lamellen sind nicht zum Tragen von Schnee- und Eislasten vorgesehen. Die Pergola ist nicht für den gewerblichen Gebrauch bestimmt.

FR - AVERTISSEMENT

- Lisez attentivement ces instructions d'installation et d'utilisation avant d'installer et d'utiliser la pergola.
- Respectez les exigences et les méthodes d'installation pour une installation correcte et sûre de la pergola.

Instructions d'utilisation

Cette pergola est adaptée à un usage extérieur et protège du soleil direct ou de l'éblouissement.

En cas de vent fort (force de vent Beaufort supérieure à 3 = plus de 19 km/h) ou de prévisions de chutes de neige, veuillez placer les lames verticalement (ouvertes). Les lames fermées ne sont pas conçues pour supporter des charges de neige et de glace. La pergola n'est pas destinée à un usage commercial.

IT - ATTENZIONE

- Leggere attentamente le presenti istruzioni per l'installazione e l'uso prima di installare e utilizzare la pergola.
- Osservare i requisiti e i metodi di installazione per una corretta e sicura installazione della pergola.

Istruzioni per l'uso

Questa pergola è adatta all'uso esterno e protegge dal sole diretto o dall'abbagliamento.

In caso di vento forte (forza del vento Beaufort superiore a 3 = più di 19 km/h) o di previsioni di nevicate, si prega di posizionare le lamelle in verticale (aperte). Le lamelle chiuse non sono progettate per sopportare carichi di neve e ghiaccio. La pergola non è destinata a un uso commerciale.

HU - FIGYELMEZTETÉS

- A pergola felszerelése és használata előtt figyelmesen olvassa el ezeket a telepítési és használati utasításokat.
- Tartsa be a telepítési követelményeket és módszereket a pergola megfelelő és biztonságos telepítése érdekében.

Használati utasítás

Ez a pergola kültéri használatra alkalmas, és véd a közvetlen napsütéstől vagy a vakító fénytől.

Erős szél (Beaufort szélerősség 3 = több mint 19 km/h) vagy hóesés előrejelzése esetén kérjük, állítsa a lamellákat függőlegesen (nyitottan). A zárt lamellákat nem hó- és jégterhelésre tervezték. A pergola nem kereskedelmi használatra készült.

NL - WAARSCHUWING

- Lees deze plaatsings- en gebruiksaanwijzing aandachtig door voordat de pergola wordt gebruikt.
- Neem de installatie-eisen en -methodes in acht voor een juiste en veilige installatie van de Pergola.

Gebruiksaanwijzing

Deze pergola is geschikt voor buitengebruik en beschermt tegen directe zon of schittering. Bij sterke wind (Beaufort windkracht meer dan 3 = meer dan 19 km/u) of sneeuwvoorspellingen, gelieve de lamellen verticaal open te zetten. De gesloten lamellen zijn niet ontworpen om sneeuw- en ijs te dragen. De pergola is niet bedoeld voor commercieel gebruik.

GB - Accessories needed

- Work gloves
- Knife or cutter
- Rubber mallet
- Tape measure
- Spirit level
- Cordless screwdriver & impact drill
- Suitable drill bits
- 2 stepladders

FR - Accessoires nécessaires

- Gants de travail
- Couteau ou cutter
- Maillet en caoutchouc
- Mètre ruban
- Niveau à bulle
- Tournevis sans fil et perceuse à percussion
- Mèches appropriées
- 2 escabeaux

HU - Szükséges tartozékok

- Munkakesztyű
- Kés vagy vágókés
- Gumikalapács
- Mérőszalag
- Vízmérték
- Akkus csavarhúzó és ütvefúró
- Megfelelő fúrófejek
- 2 létra

DE - Benötigtes Zubehör

- Arbeitshandschuhe
- Messer oder Cutter
- Gummihammer
- Maßband
- Wasserwaage
- Akkuschauber & Schlagbohrmaschine
- Passende Bohrer
- 2 Stehleitern

IT - Accessori necessari

- Guanti da lavoro
- Coltello o taglierino
- Mazzuolo di gomma
- Metro a nastro
- Livella a bolla d'aria
- Avvitatore a batteria e trapano a percussione
- Punta da trapano adatte
- 2 scalette

NL - Accessoires nodig

- Werkhandschoene
- Mes of snijde
- Rubberen hame
- Rolmaa
- Waterpa
- Accuschroevendraaier & klopboormachin
- Geschikte bore
- 2 trapladder

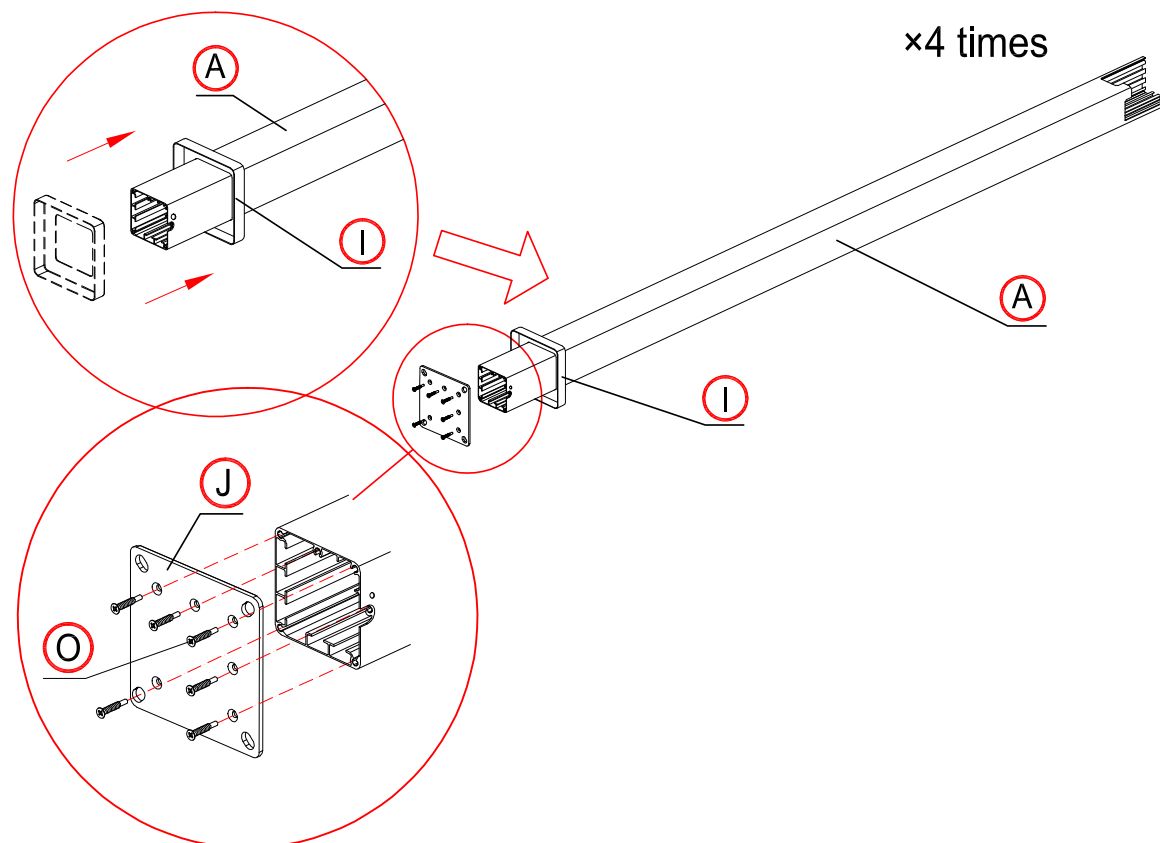

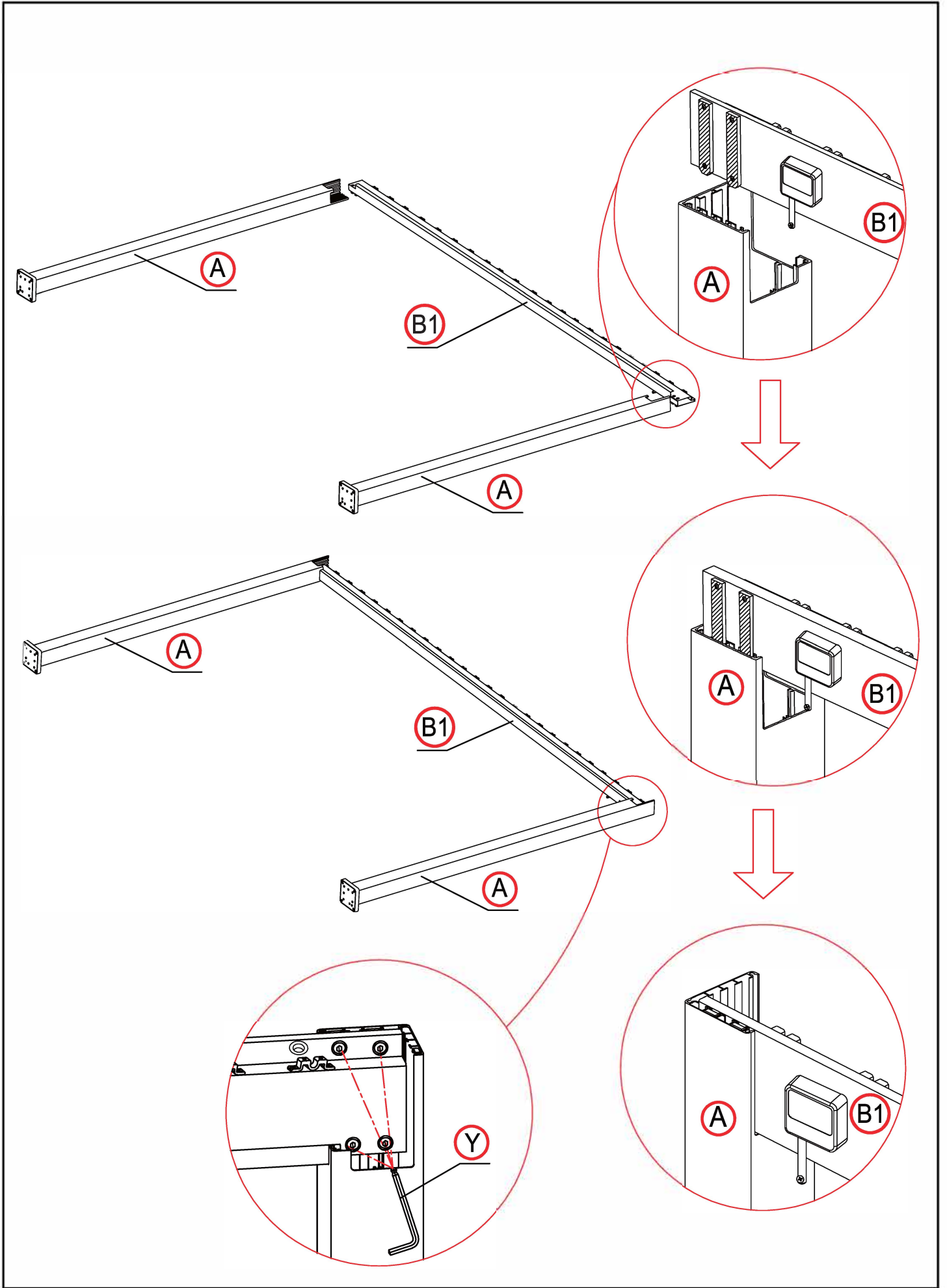

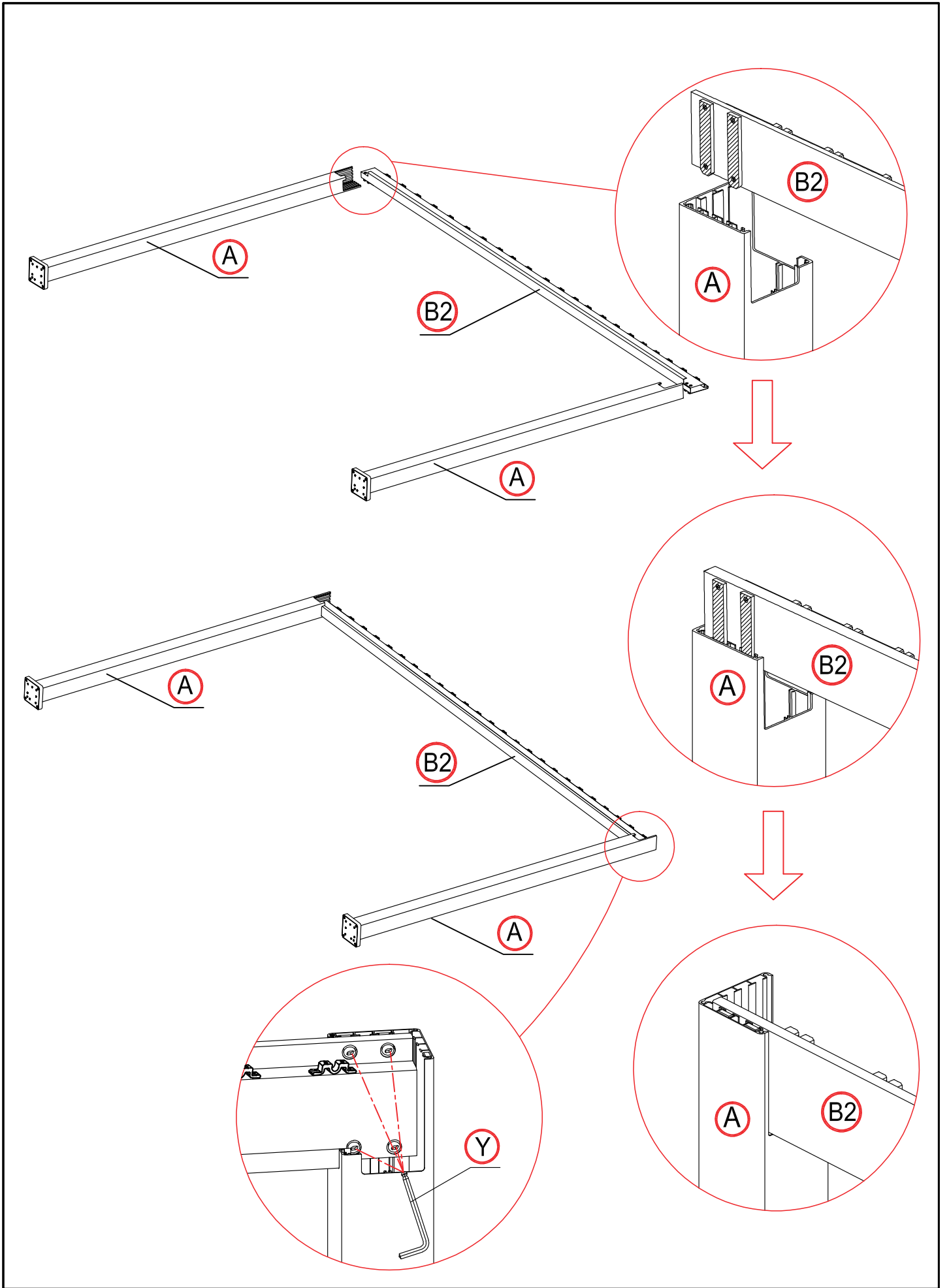

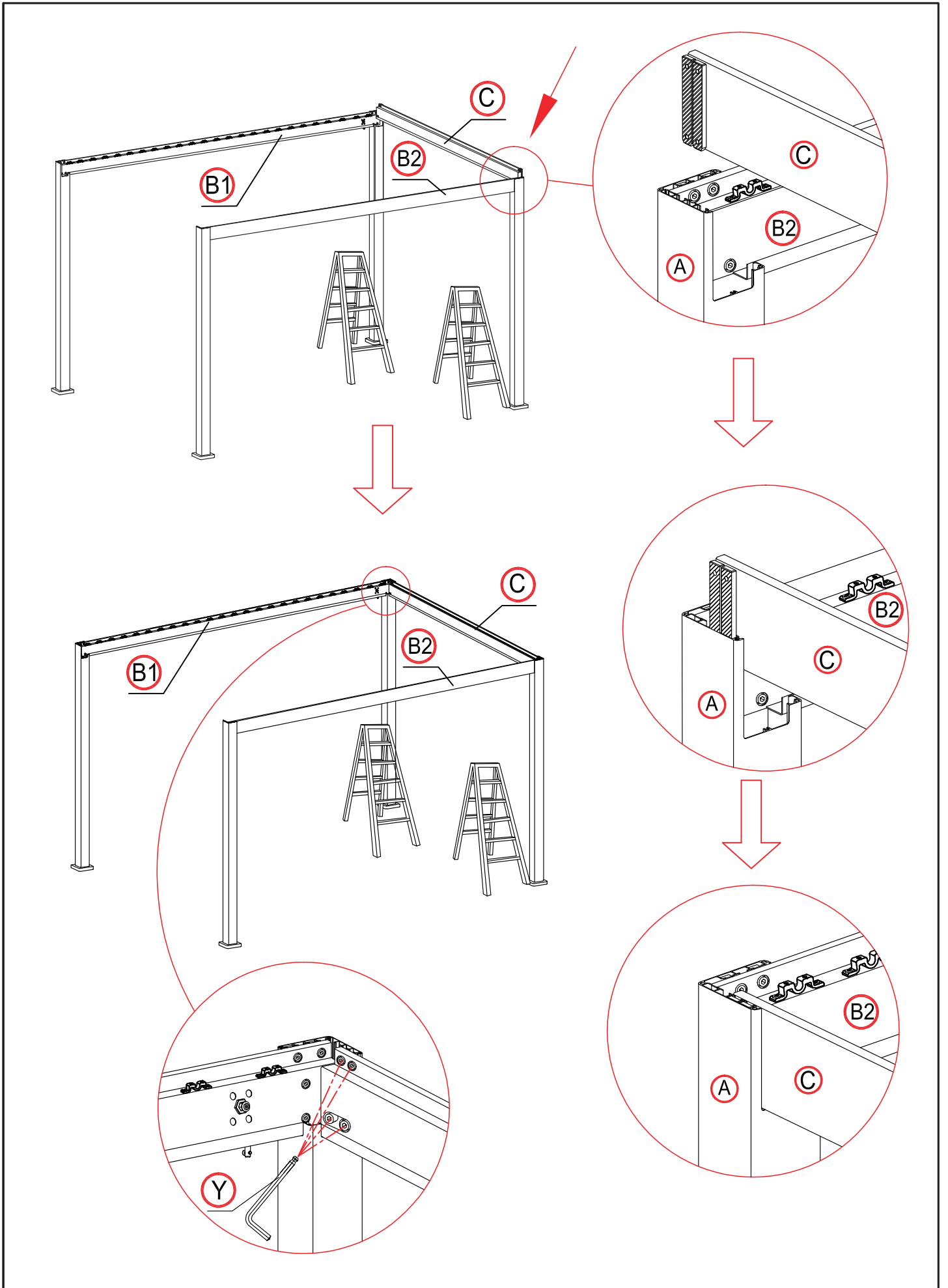

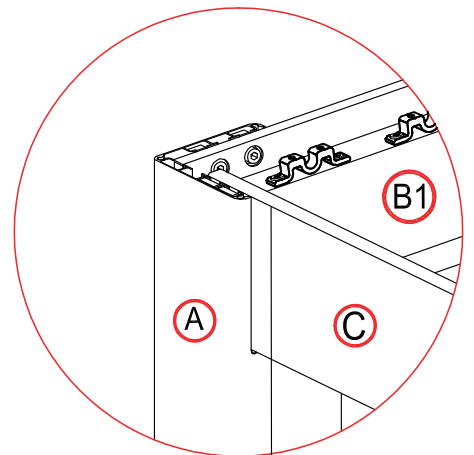
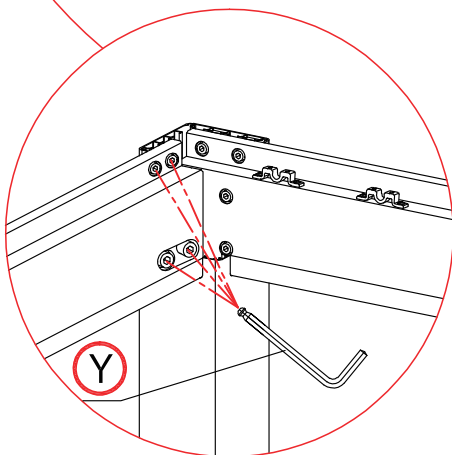
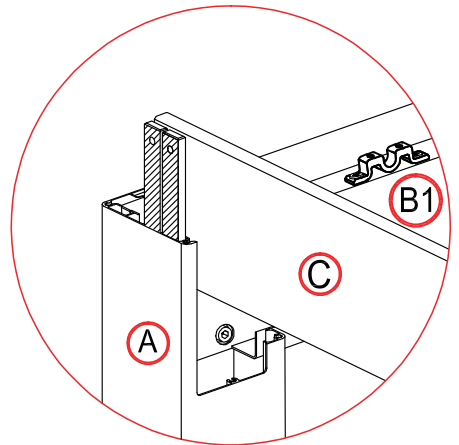
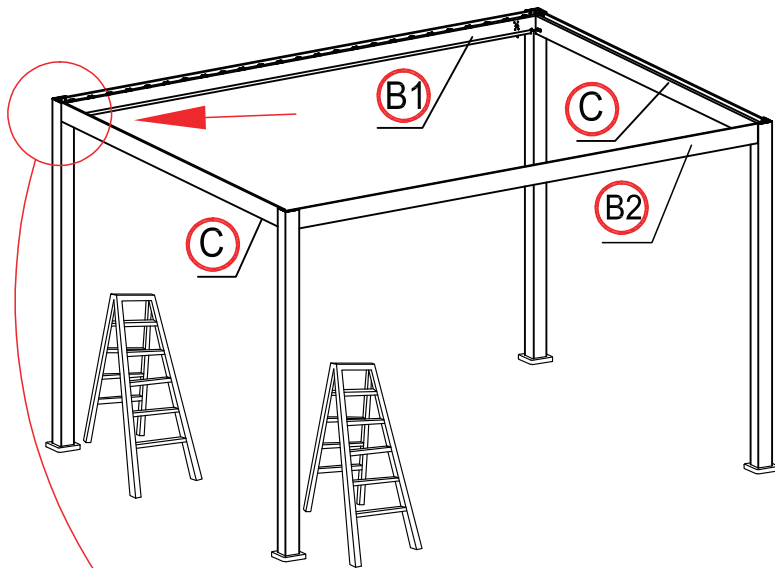
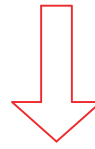
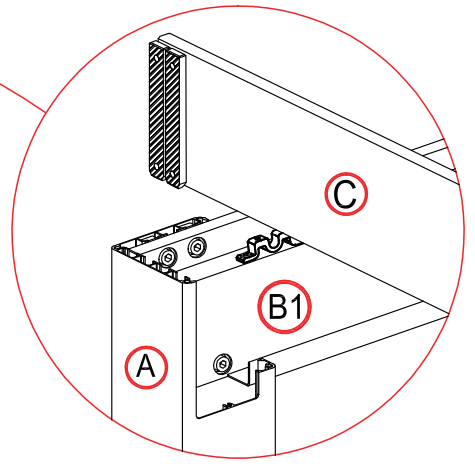
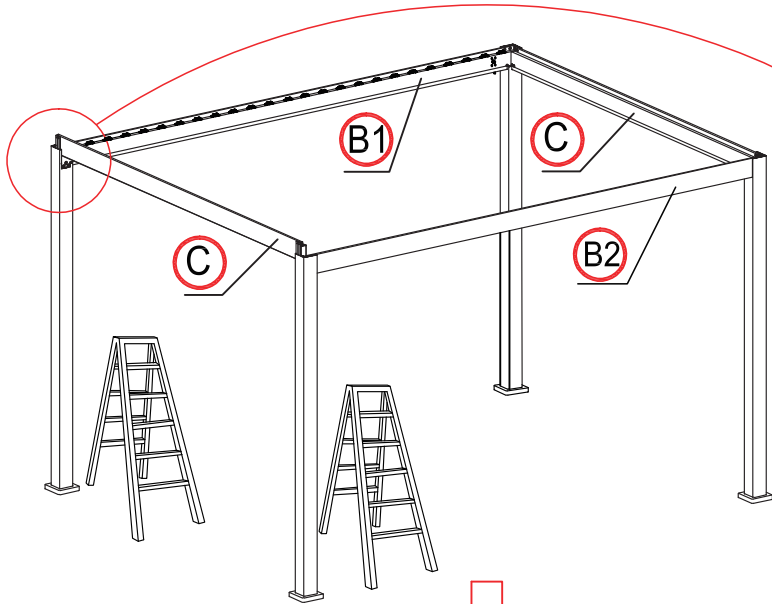

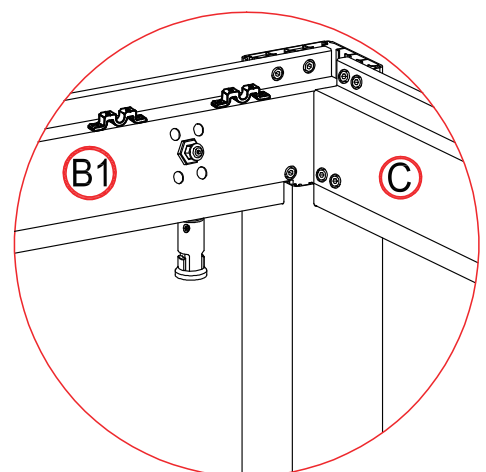
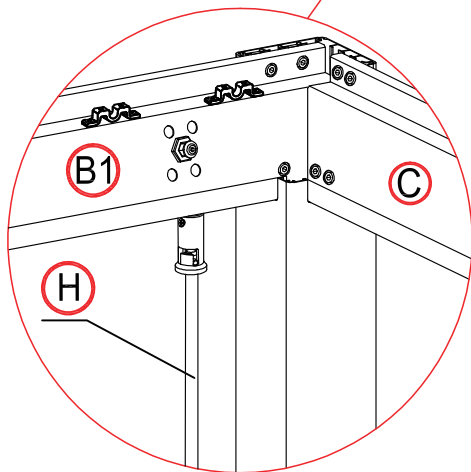
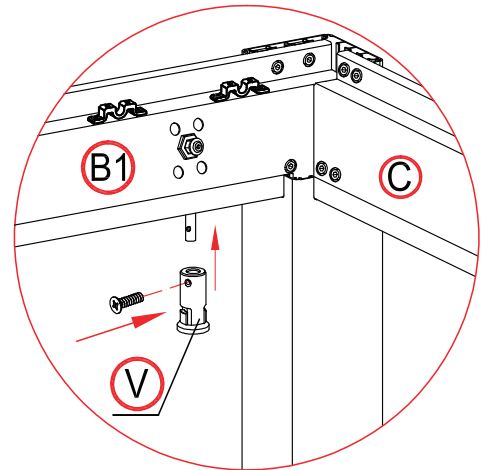
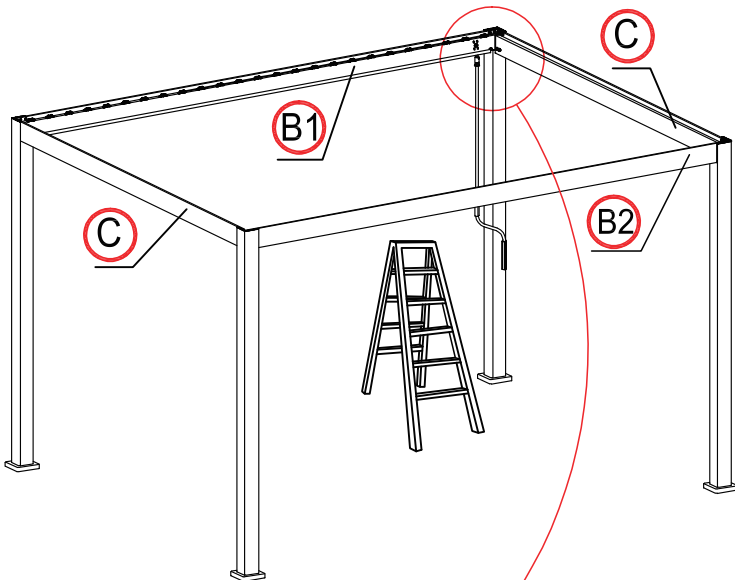
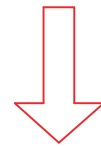
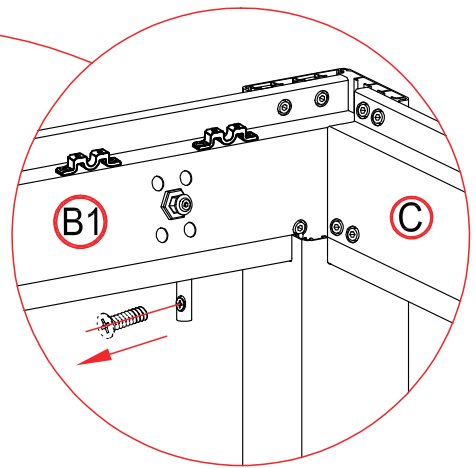
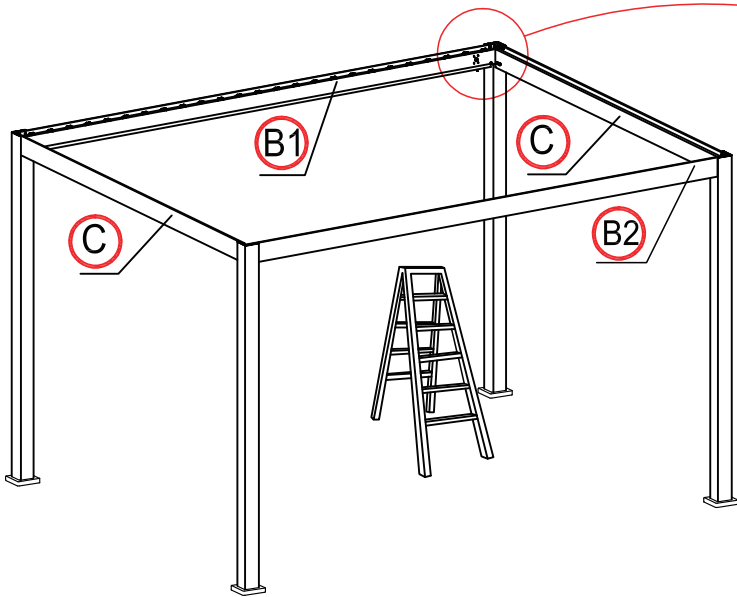

×1 time

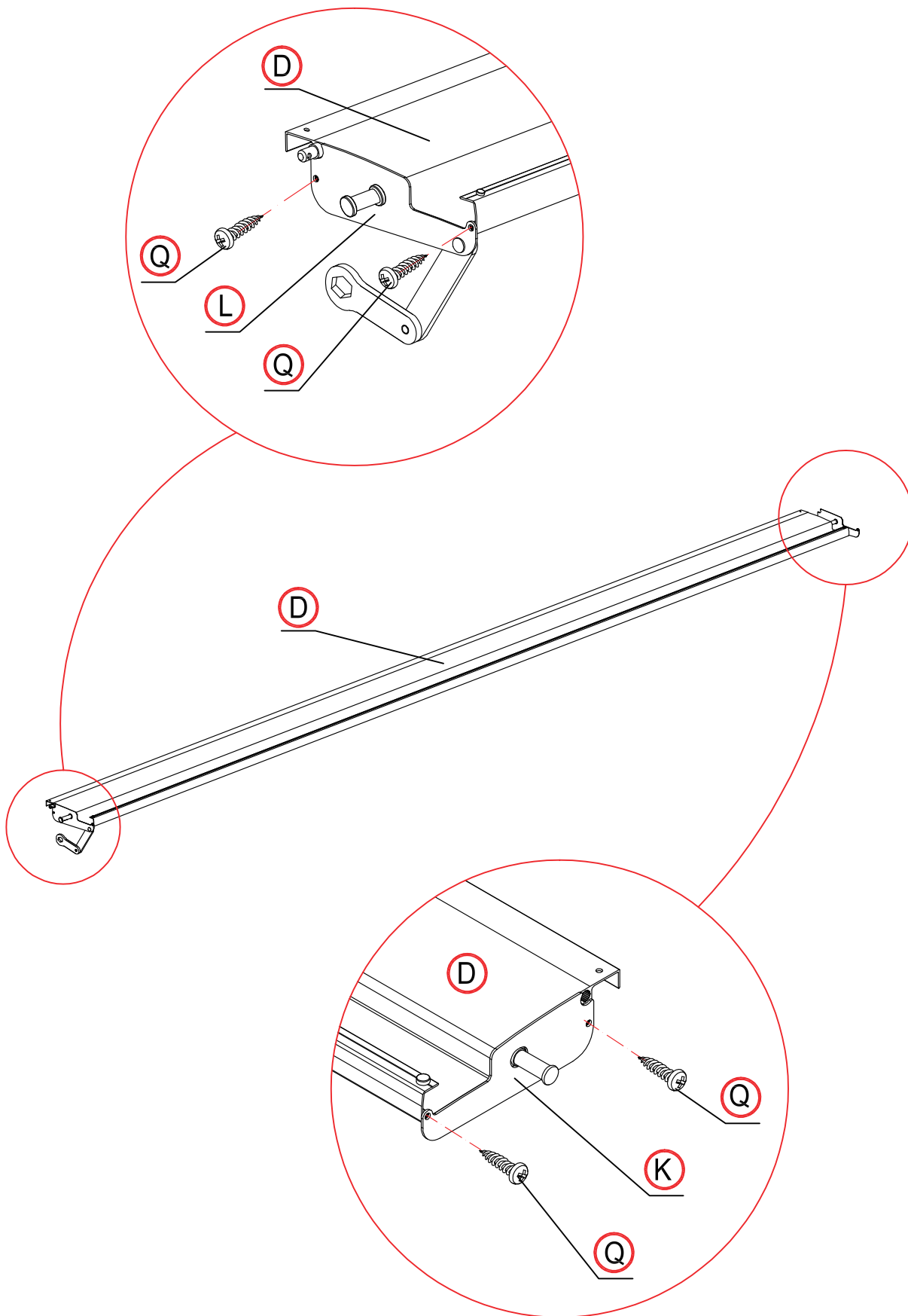

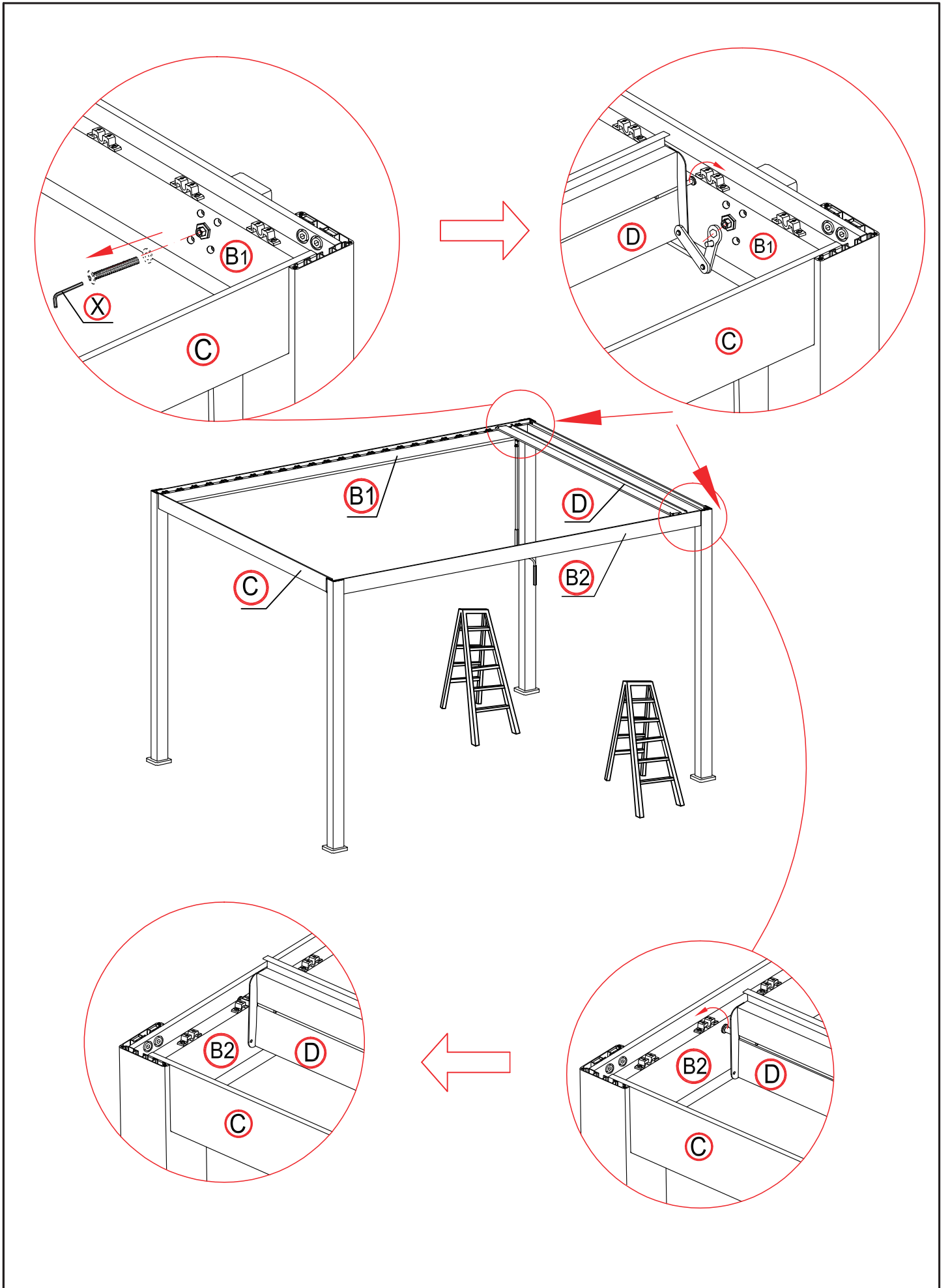

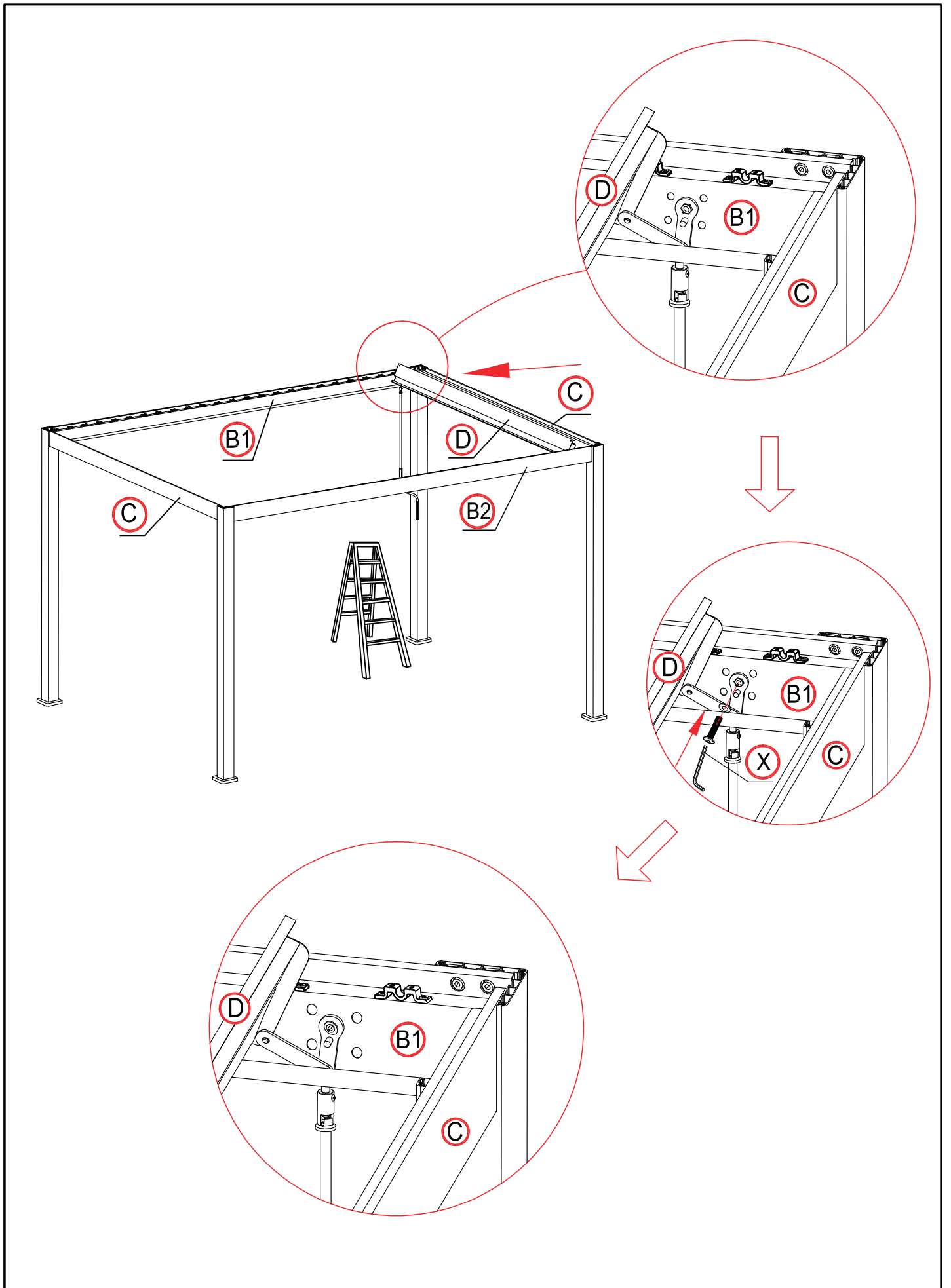

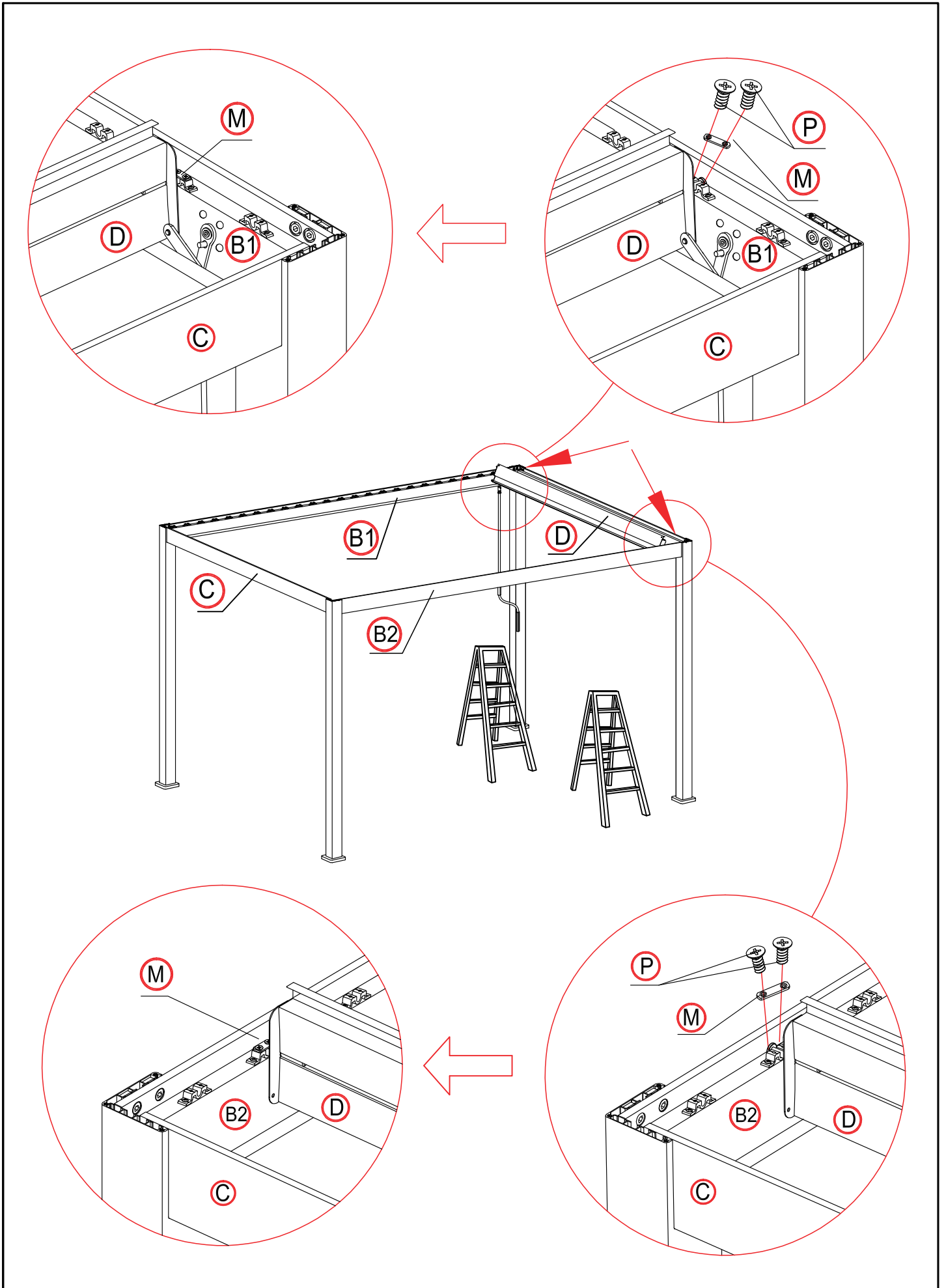

×24 times

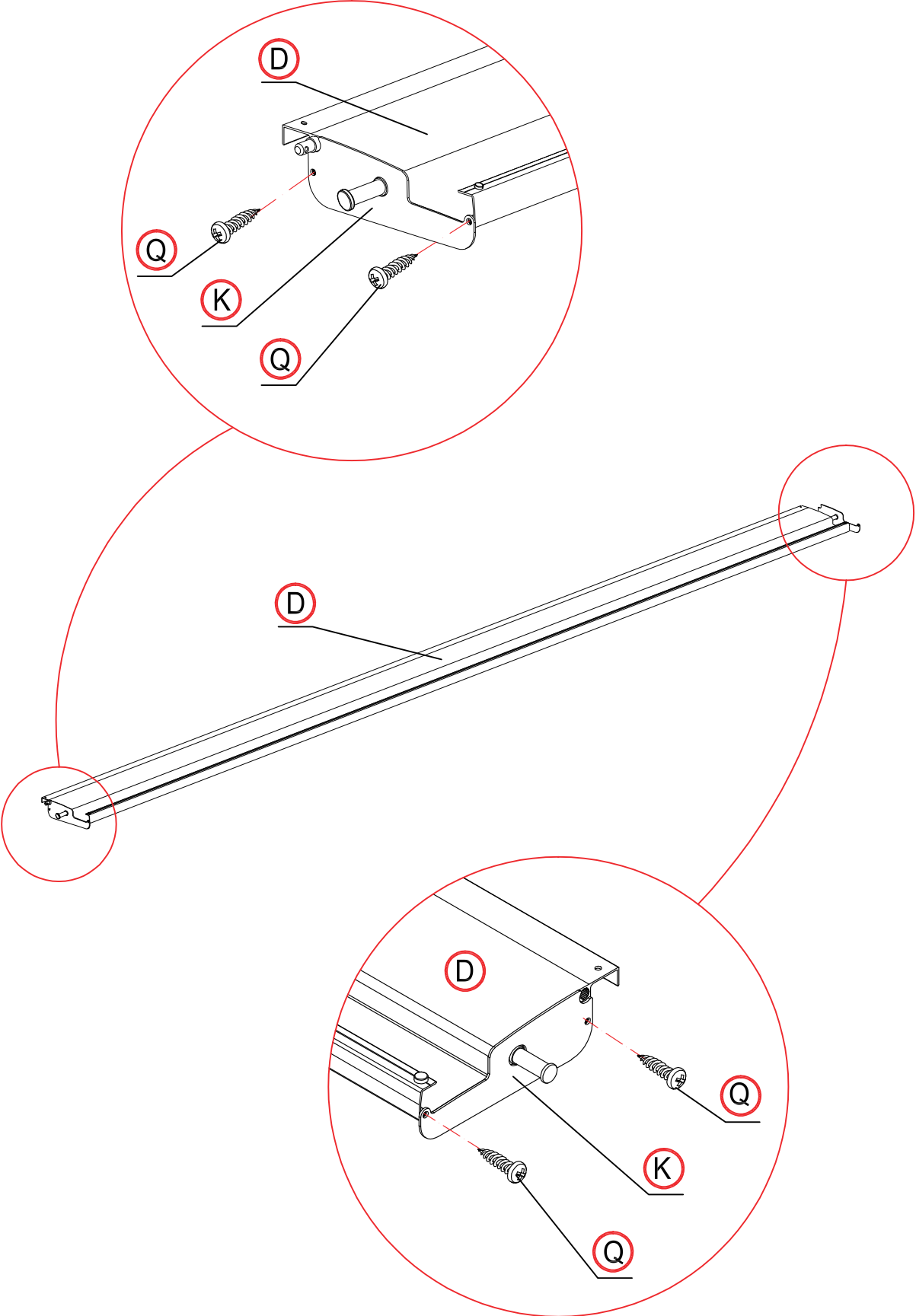

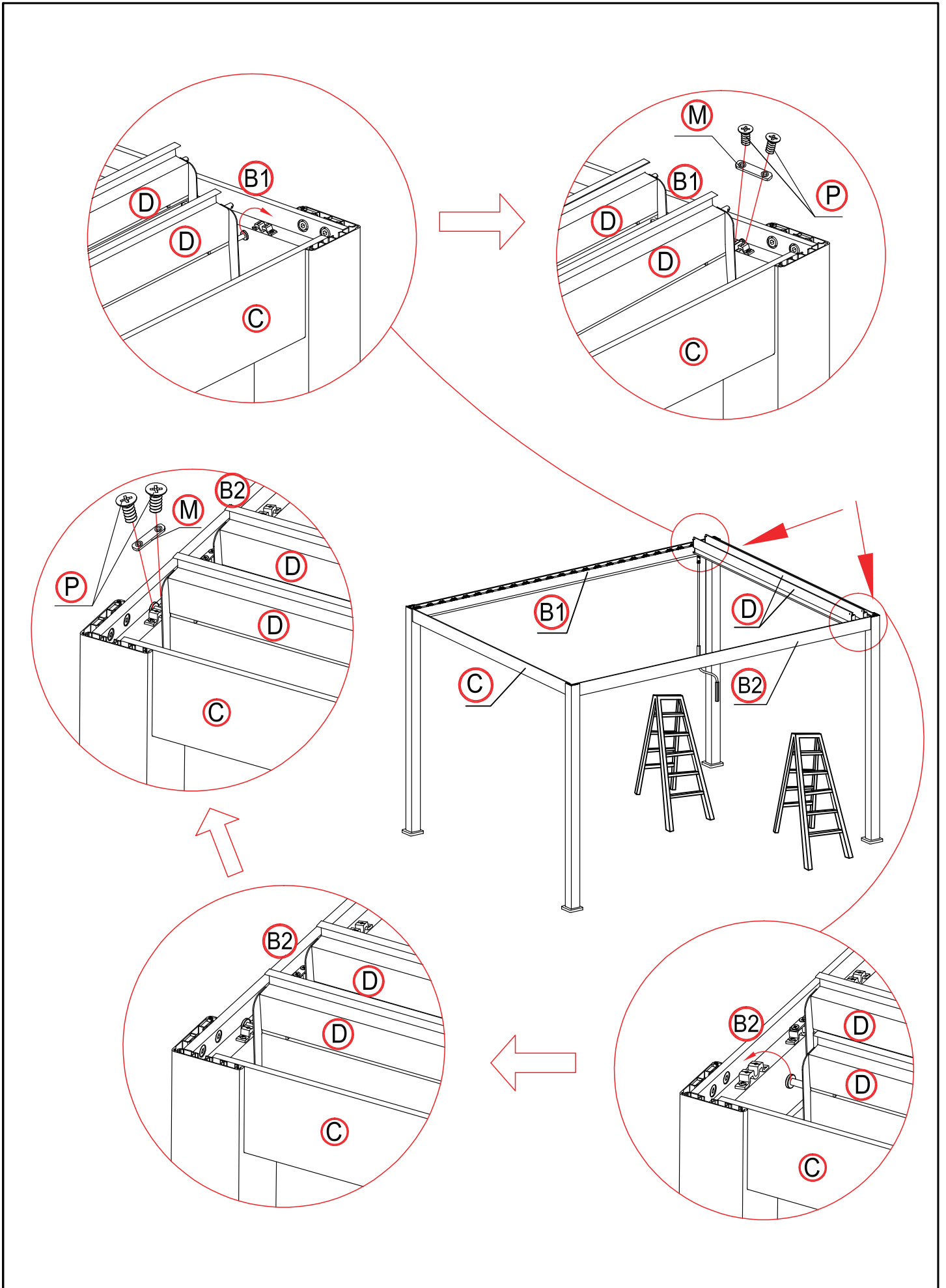

Set the slats vertically

Die Lamellen vertikal stellen

Placez les lattes verticalement

Posizionare le lamelle in verticale

Állítsa a léceket függőlegesen

Zet de lamellen verticaal

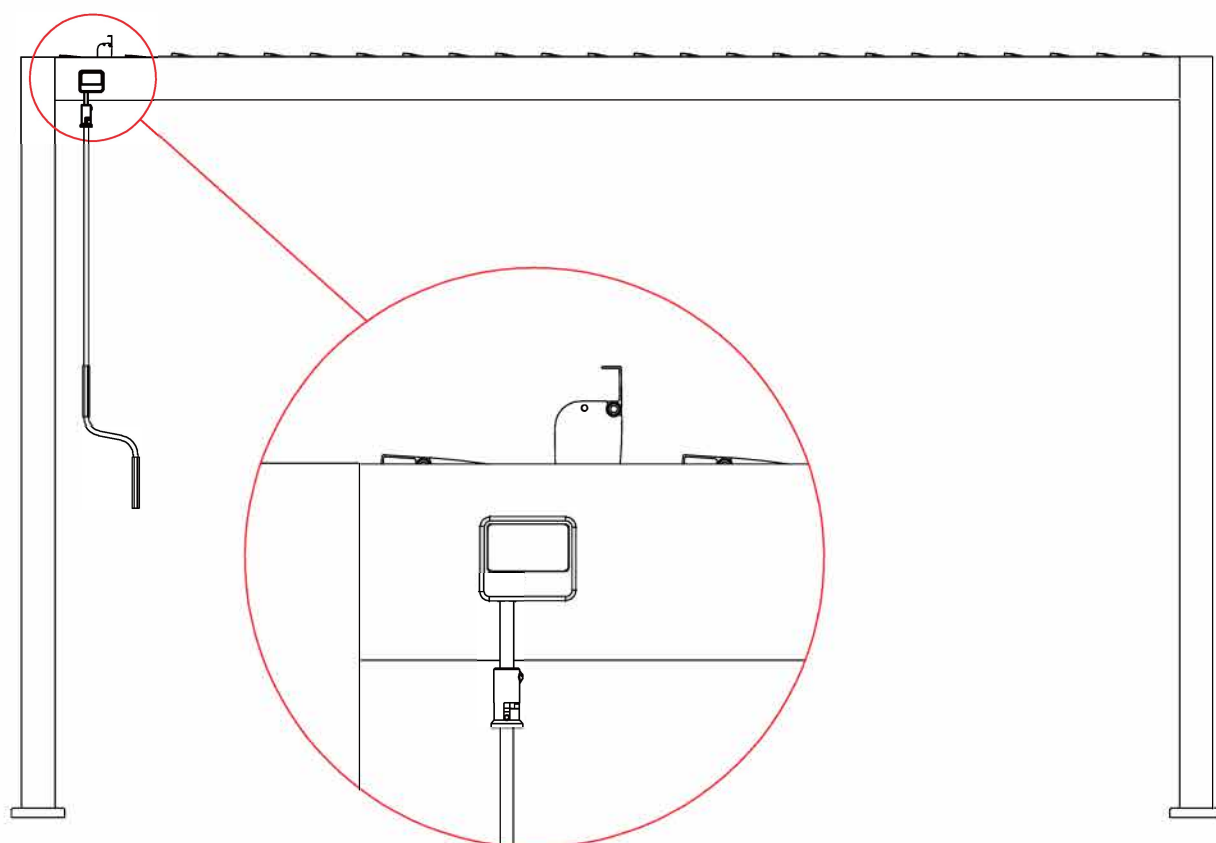

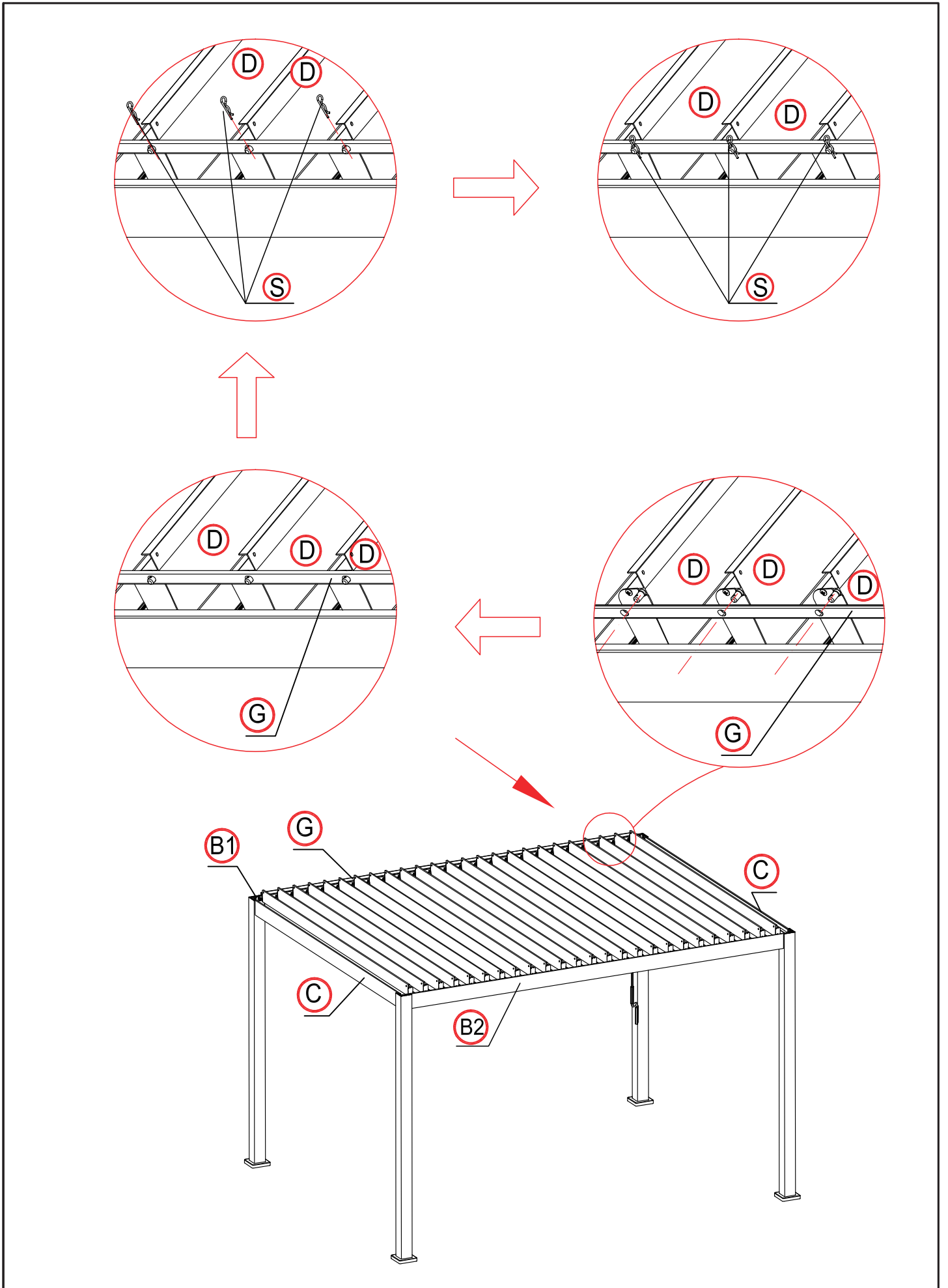

×4 times

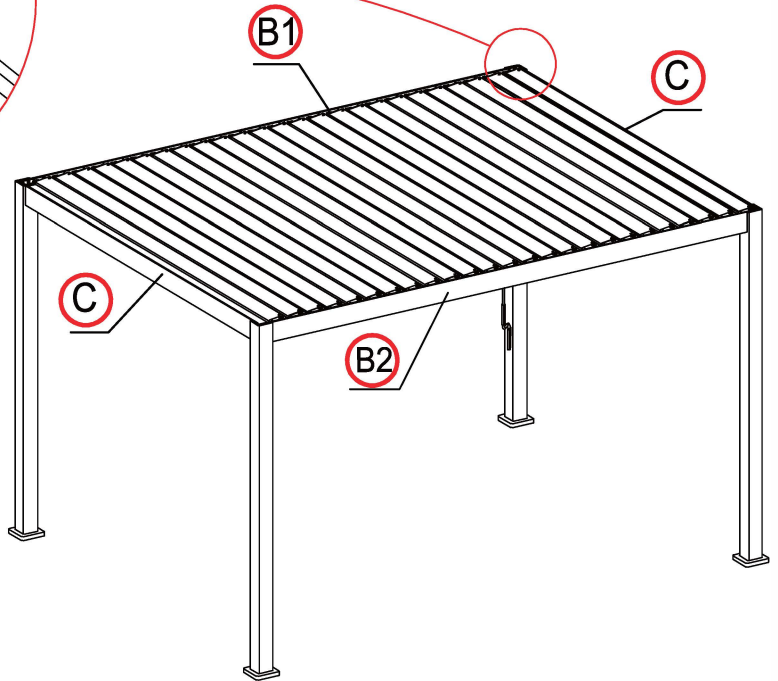
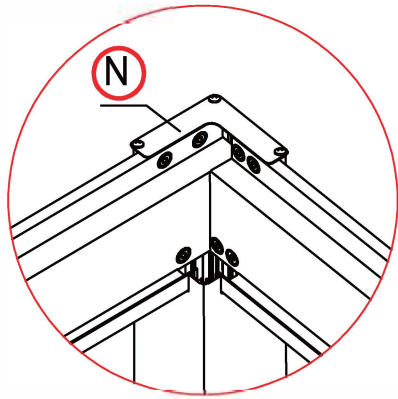
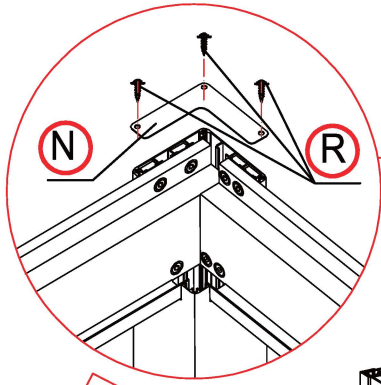

×4 times

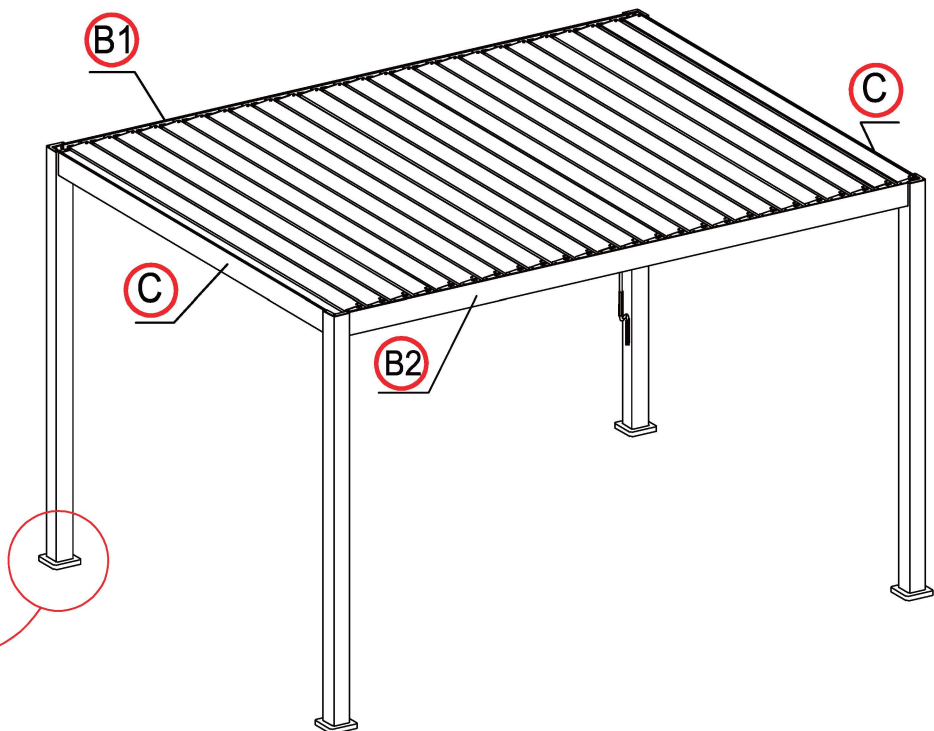
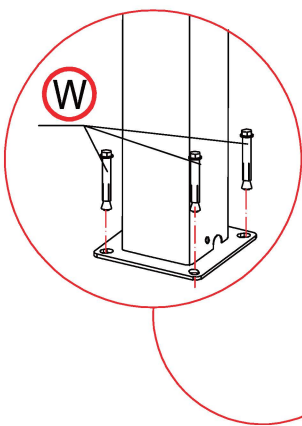

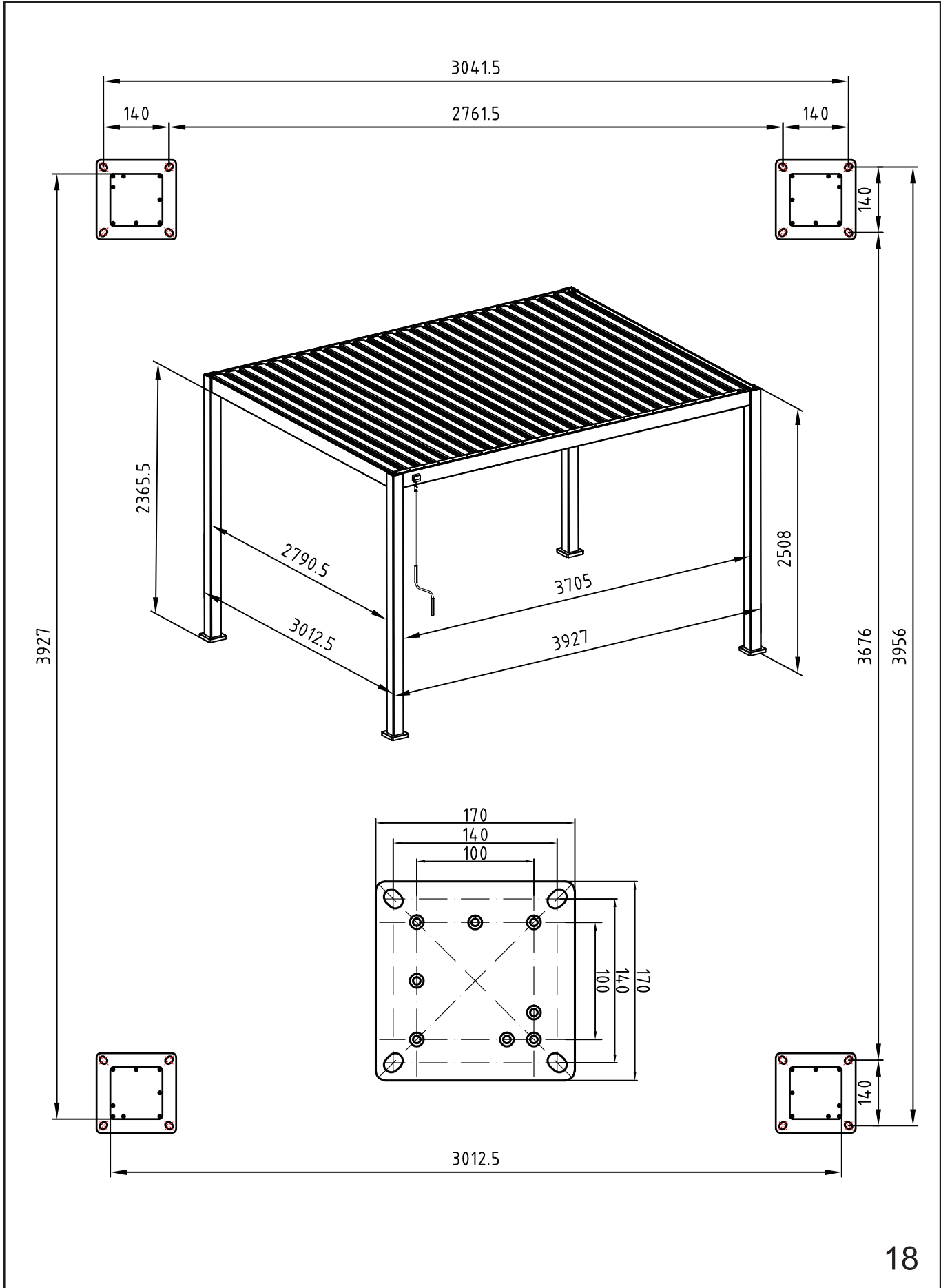

GB - Anchoring the feet

The pergola must be anchored in a stable manner. Either in suitable solid ground or there must be frostproof load-bearing foundations must be built. An example: 30 x 30 and approx. 80 cm frost depth.

Cleaning and maintenance

Remove dirt and dust with a mixture of water and soap (household cleaner) and a soft, clean cloth. If friction noises occur during operation, lubricate with silicone-based products.

DE - Verankerung der Füße

Die Pergola muss standsicher verankert werden. Entweder in geeignetem festem Untergrund oder es müssen frostsichere tragfähige Fundamente gebaut werden. Ein Beispiel: 30 x 30 und ca. 80 cm Frosttiefe.

Reinigung und Wartung

Schmutz und Staub mit einer Mischung aus Wasser und Seife (Haushaltsreiniger) und einem weichen, sauberen Tuch entfernen. Sollten Reibungsgeräusche bei der Bedienung auftreten mit silikonbasierten Mitteln schmieren.

FR - Ancrage des pieds

La pergola doit être ancrée de manière stable. Soit dans un sol solide approprié, soit il doit y avoir des fondations porteuses à l'épreuve du gel doivent être construites. Un exemple : 30 x 30 et une profondeur de gel d'environ 80 cm.

Nettoyage et entretien

Enlever la saleté et la poussière avec un mélange d'eau et de savon (nettoyant ménager) et un chiffon doux et propre. Si des bruits de frottement se produisent pendant le fonctionnement, lubrifiez avec des produits à base de silicone.

IT - Ancoraggio dei piedi

La pergola deve essere ancorata in modo stabile. In un terreno solido e adatto o in una fondazione portante antigelo. è necessario costruire delle fondamenta portanti a prova di gelo. Un esempio: 30 x 30 e circa 80 cm di profondità di gelo.

Pulizia e manutenzione

Rimuovere lo sporco e la polvere con una miscela di acqua e sapone (detergente domestico) e un panno morbido e pulito. Se durante il funzionamento si verificano rumori di attrito, lubrificare con prodotti a base di silicone.

HU - A lábak rögzítése

A pergolát stabilan le kell horgonyozni. Vagy megfelelő szilárd talajba, vagy pedig kell lennie fagyálló teherbíró alapokat kell építeni. Egy példa: 30 x 30 és kb. 80 cm-es fagymélység.

Tisztítás és karbantartás

A szennyeződések és a port víz és szappan (háztartási tisztítószer) keverékével és egy puha, tiszta ruhával távolítsa el. Ha működés közben súrlódási zajok lépnek fel, kenje be szilikon alapú termékekkel.

NL - Verankering van de palen

De pergola moet stabiel worden verankerd. Ofwel in geschikte vaste grond ofwel vorstvrij er moeten dragende funderingen worden gebouwd. Een voorbeeld: 30 x 30 en ca. 80 cm vorstdiepte.

Reiniging en onderhoud

Verwijder vuil en stof met een mengsel van water en zeep (huishoudelijk schoonmaakmiddel) en een zachte, schone doek. Als er tijdens het gebruik wrijvingsgeluiden optreden, smeer dan met producten op siliconenbasis.