

4018211 200238

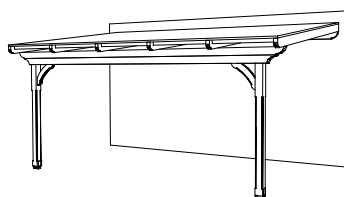

4018211 200290

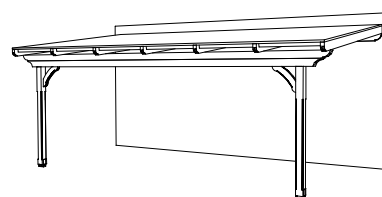

4018211 200351

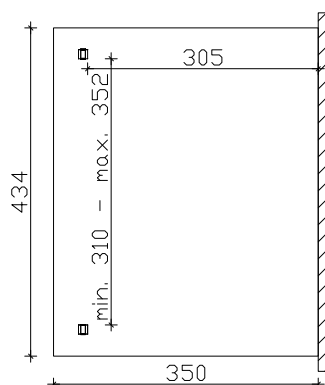

Grundriss

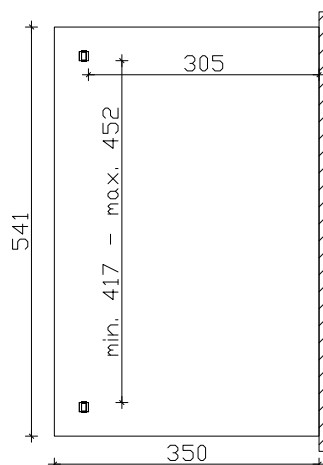

Grundriss

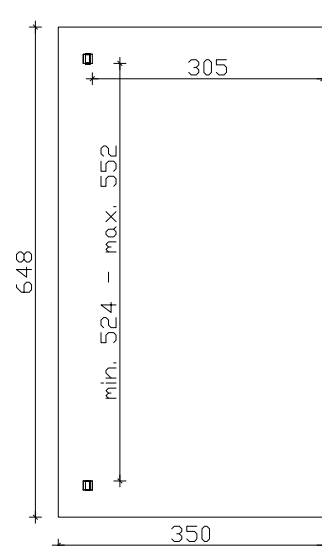

Grundriss

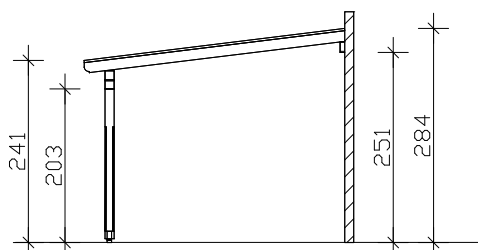

Seitenansicht

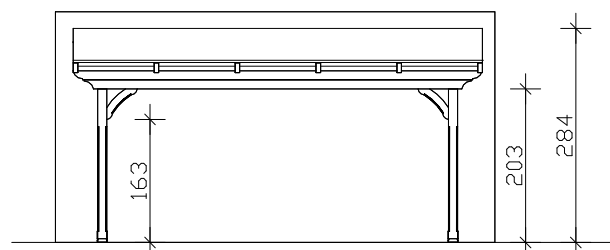

Frontansicht

M 1:100

## "Ravenna" Terrassenüberdachung 434cm / 541cm / 648cm x 350cm

### Datenblatt / Baubeschreibung

<b>Holzart / Eisenteile</b>	<b>Douglasie, unbehandelt / verzinkt</b>
<b>Pfosten</b>	<b>2 Stück 12x12x198cm</b>
<b>Dacheindeckung</b>	<b>Polycarbonat Doppelstegplatten 16mm (transparent)</b>
<b>Schneelast</b>	<b>sk = 1,75kN/m<sup>2</sup></b>
<b>Breite x Tiefe</b>	<b>434cm / 541cm / 648cm x 350cm</b>
<b>Gesamthöhe / Durchgang</b>	<b>241-284cm / 203cm (inkl. Abstand zum Boden, Aufschraubstütze = 5cm)</b>
<b>Fläche (umb.Raum)</b>	<b>15,19m<sup>2</sup> (39,87m<sup>3</sup>) / 18,94m<sup>2</sup> (49,71m<sup>3</sup>) / 22,68m<sup>2</sup> (59,54m<sup>3</sup>)</b>
<b>Dachneigung</b>	<b>7°</b>
<b>Verpackungseinheit</b>	<b>BxLxH 110x450-655x38-46cm / Gewicht 300/355/410kg</b>
<b>Inklusive</b>	<b>Montagematerial, Aufschraubstützen, Kopfbänder, Aufbauanleitung</b> (ohne Dübel für Wandbefestigung, ohne Wandabdichtungsprofile)