



Temponox-Bogen 90° mit SC-Contur

- Pressanschlüsse

Ausstattung

Dichtelemente EPDM

Modell 1716

Artikel 809 638

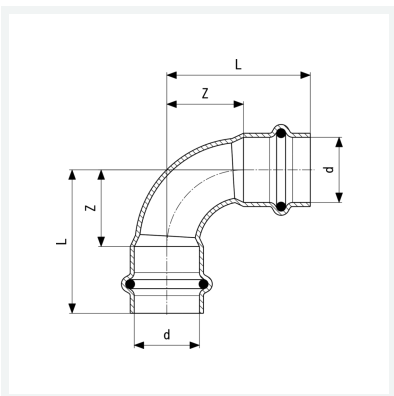

Eigenschaften

Rohraußendurchmesser	d	15
Länge	L	38 mm
Z-Maß	Z	16 mm
Gewicht	41,8 g	
Volumen	82,88 cm ³	
Werkstoff	Stahl nichtrostend	