

# Kids Climbing Dome with Slide

ACCORDING TO SAFETY REQUIREMENTS

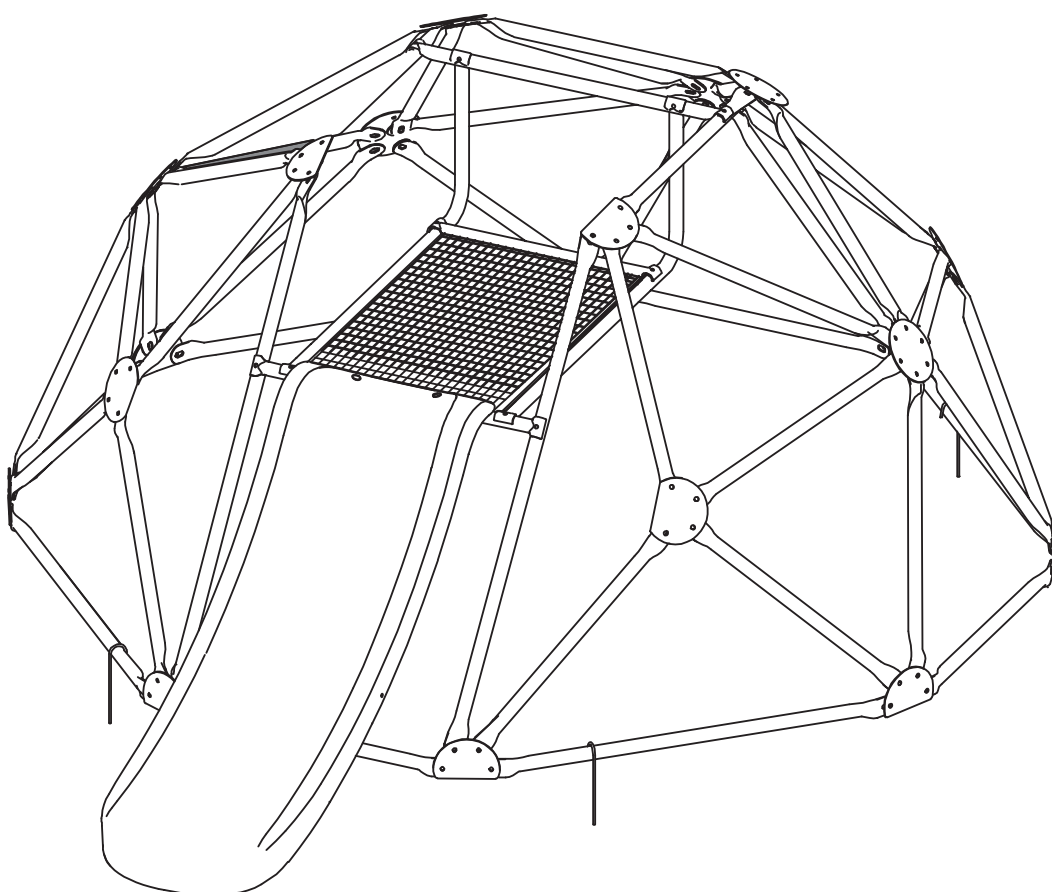

CE







**ORIGINAL INSTRUCTION MANUAL  
RETAIN FOR FUTURE REFERENCE**







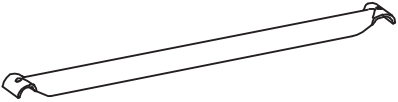

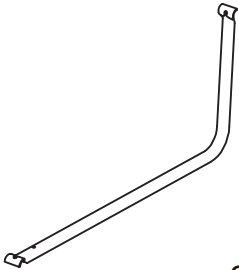

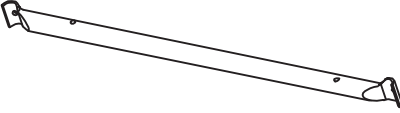
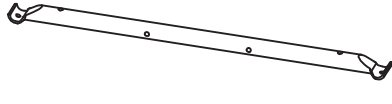
- ⚠ Danger! Keep all small parts and packaging materials for this product away from babies and children, otherwise they may pose a choking hazard.
- ⚠ The product must be installed and used under the supervision of an adult.
- ⚠ Read through each step carefully and follow the proper order.
- ⚠ Remove all packaging, separate and count all parts and hardware before installation.
- ⚠ Please ensure that all parts are correctly installed, incorrect installation can lead to a danger.
- ⚠ We recommend that, where possible, all items are assembled near the area in which they will be placed in use, to avoid moving the product unnecessarily once assembled.
- ⚠ Ensure a secure surface during installation, and always place the product on a flat, steady and stable surface.

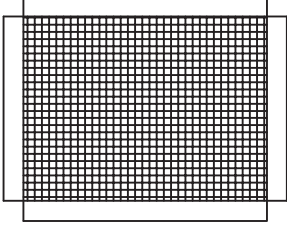
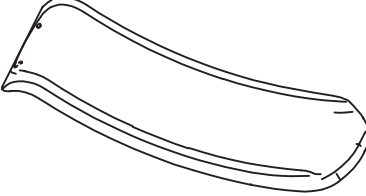
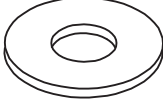
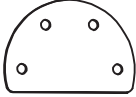
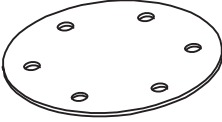
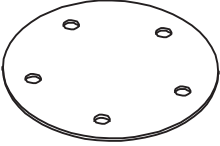
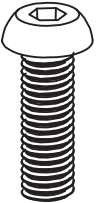
## PARTS LIST

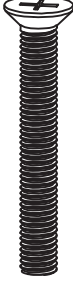
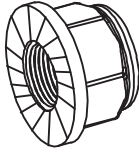
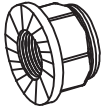
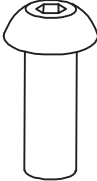
**Note:** Some of these parts have extra spare parts.

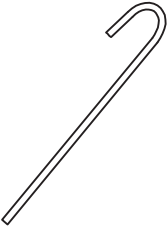
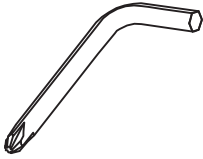
<p><b>A</b></p>  <p>blue 17pcs</p>	<p><b>B</b></p>  <p>red 18pcs</p>	<p><b>C</b></p>  <p>blue 4pcs</p>
<p><b>D</b></p>  <p>blue 1pc</p>	<p><b>E</b></p>  <p>blue 2pcs</p>	<p><b>F</b></p>  <p>blue 2pcs</p>

<p><b>G</b></p>  <p>blue 1pc</p>	<p><b>H</b></p>  <p>blue 1pc</p>	<p><b>Q</b></p>  <p>blue 2pcs</p>	
<p><b>I</b></p>  <p>1pc</p>	<p><b>P</b></p>  <p>1pc</p>	<p><b>D8</b></p>  <p>10pcs</p>	
<p><b>F1</b></p>  <p>12pcs</p>	<p><b>F2</b></p>  <p>3pcs</p>	<p><b>F3</b></p>  <p>4pcs</p>	
<p><b>Z10</b></p>  <p>M8x13 86pcs</p>	<p><b>Z14</b></p>  <p>M6x20 10pcs</p>	<p><b>Z15</b></p>  <p>M5x42 2pcs</p>	
<p><b>K</b></p>  <p>M8 86pcs</p>	<p><b>N</b></p>  <p>M5 2pcs</p>	<p><b>G8</b></p>  <p>10pcs</p>	
<p><b>L8</b></p>  <p>10pcs</p>	<p><b>O</b></p>  <p>4pcs</p>	<p><b>A5</b></p>  <p>2pcs</p>	<p><b>K1013</b></p>  <p>1pc</p>

# ASSEMBLY

1

First assemble the 3 parts in the shape of (\*) shown in the figure for use in the subsequent installation steps. The green lines represent the parts required for the current installation.

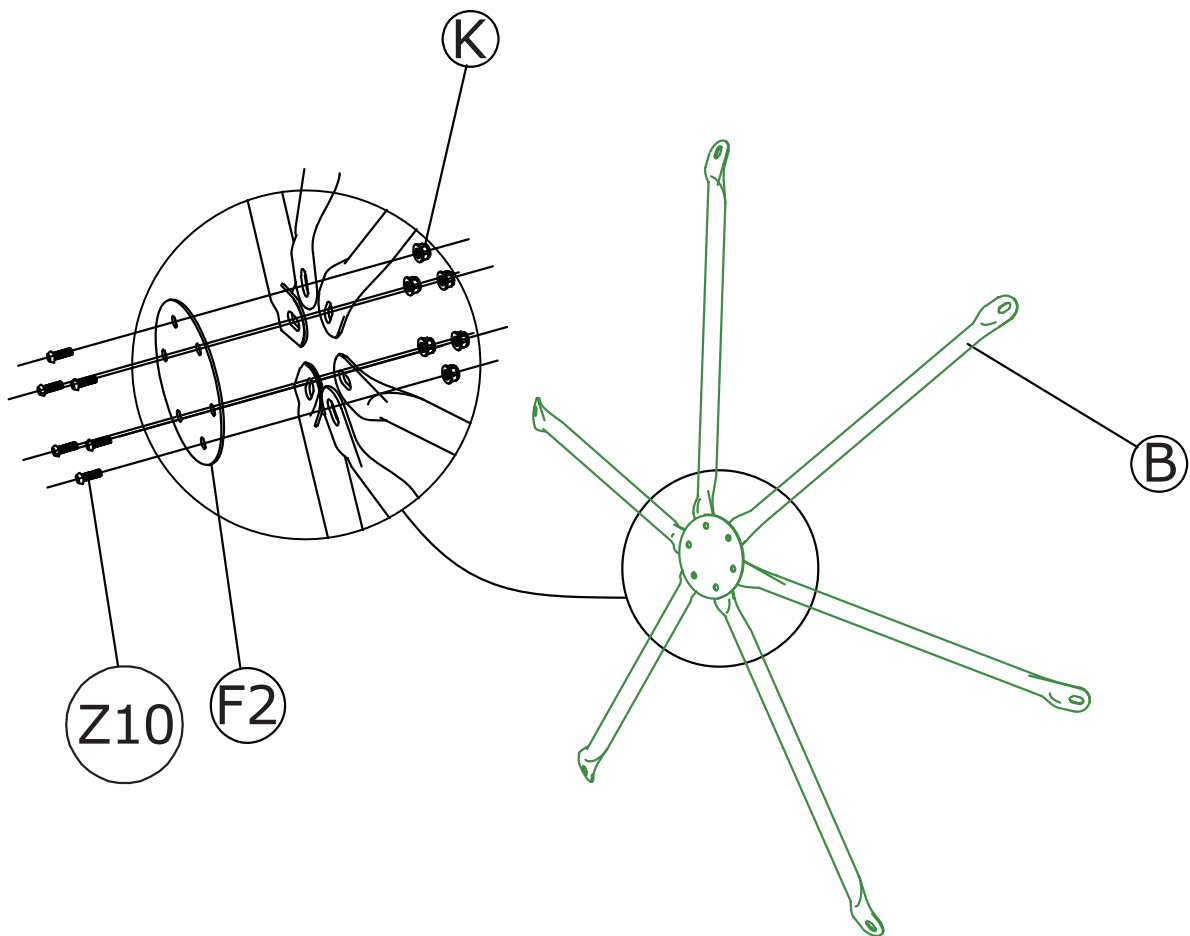

×3

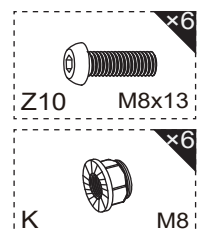

Use F1 to alternately connect A and C to form an octagon.

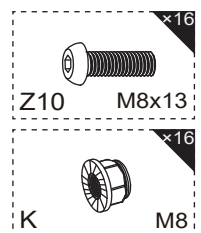
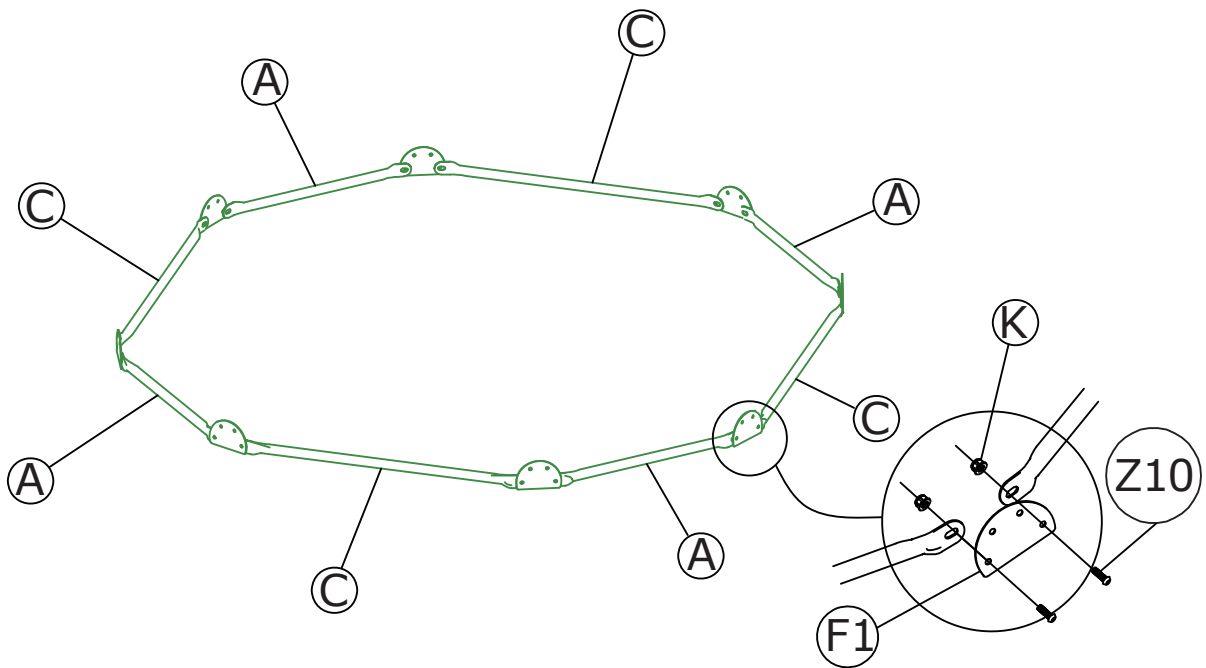
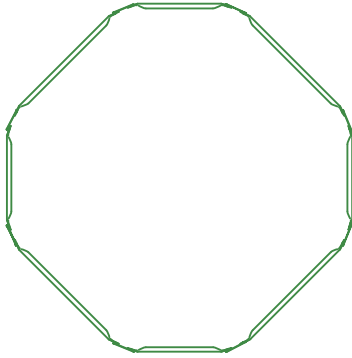

3

Use F1, F3, A, and Q to connect the assembly parts(\*) in the first step to form a hexagon.

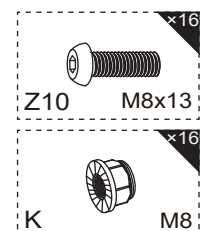
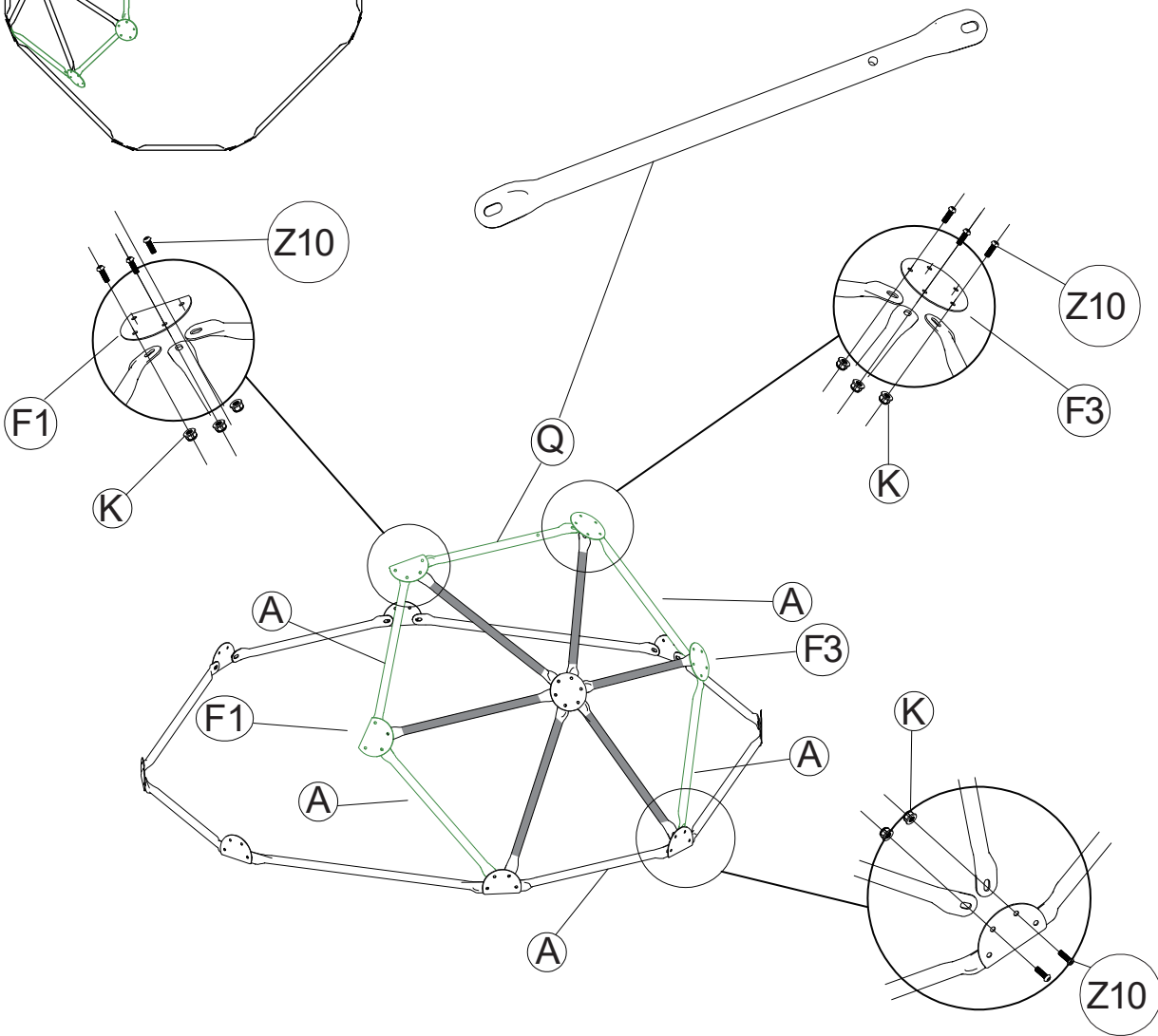
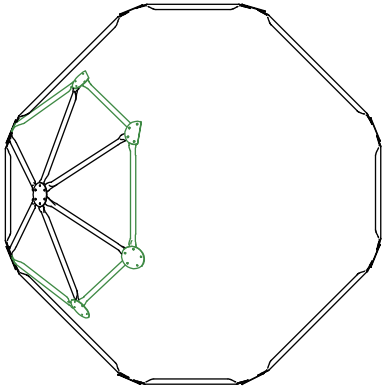

Use A and F3 to connect the assembly parts(\*) in the first step to form the structure shown in the picture.

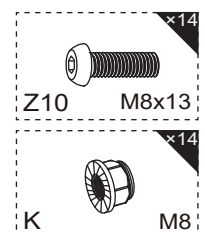
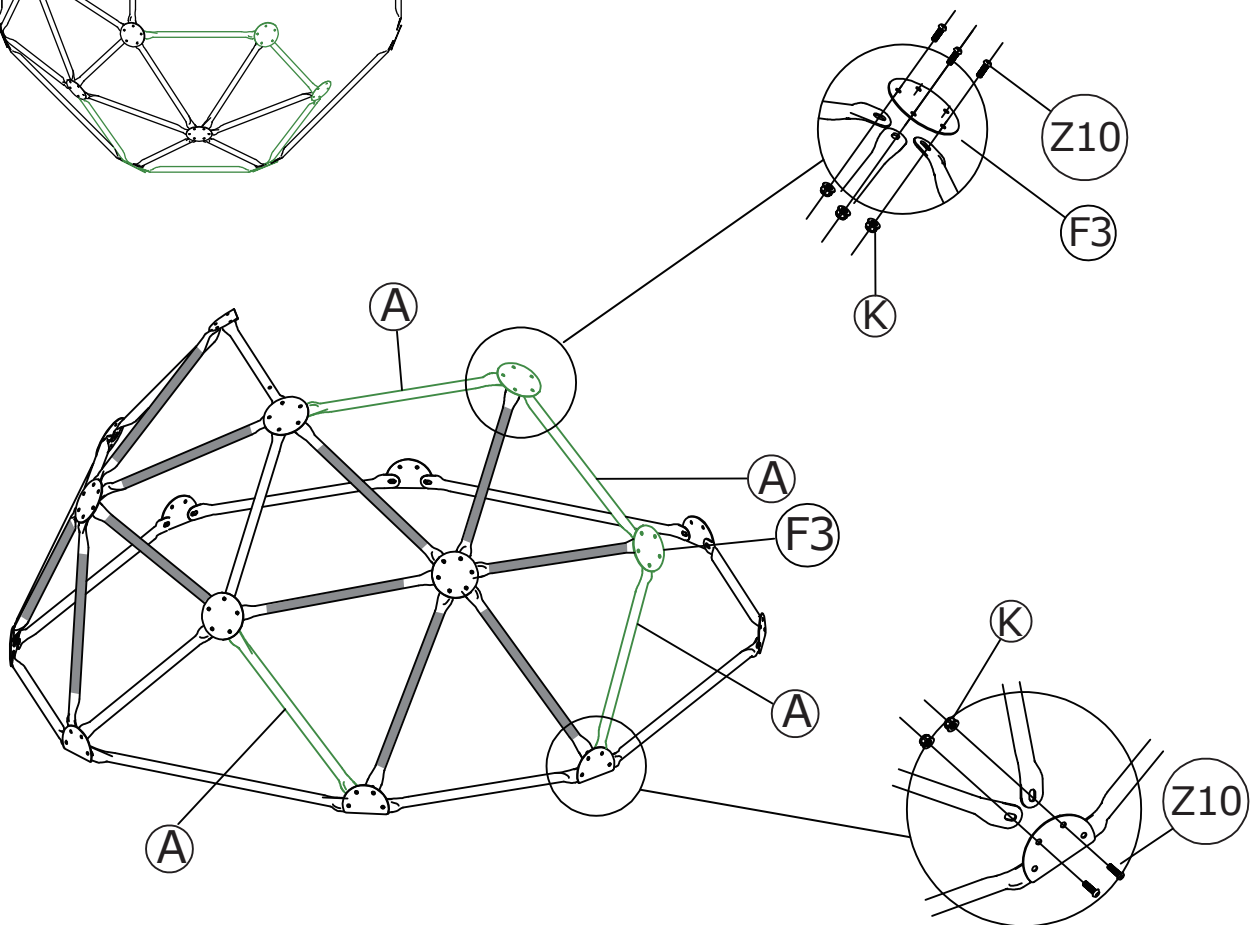
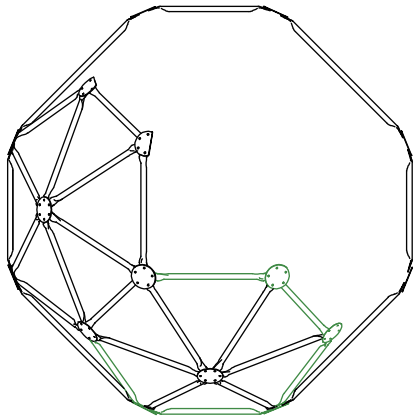

5



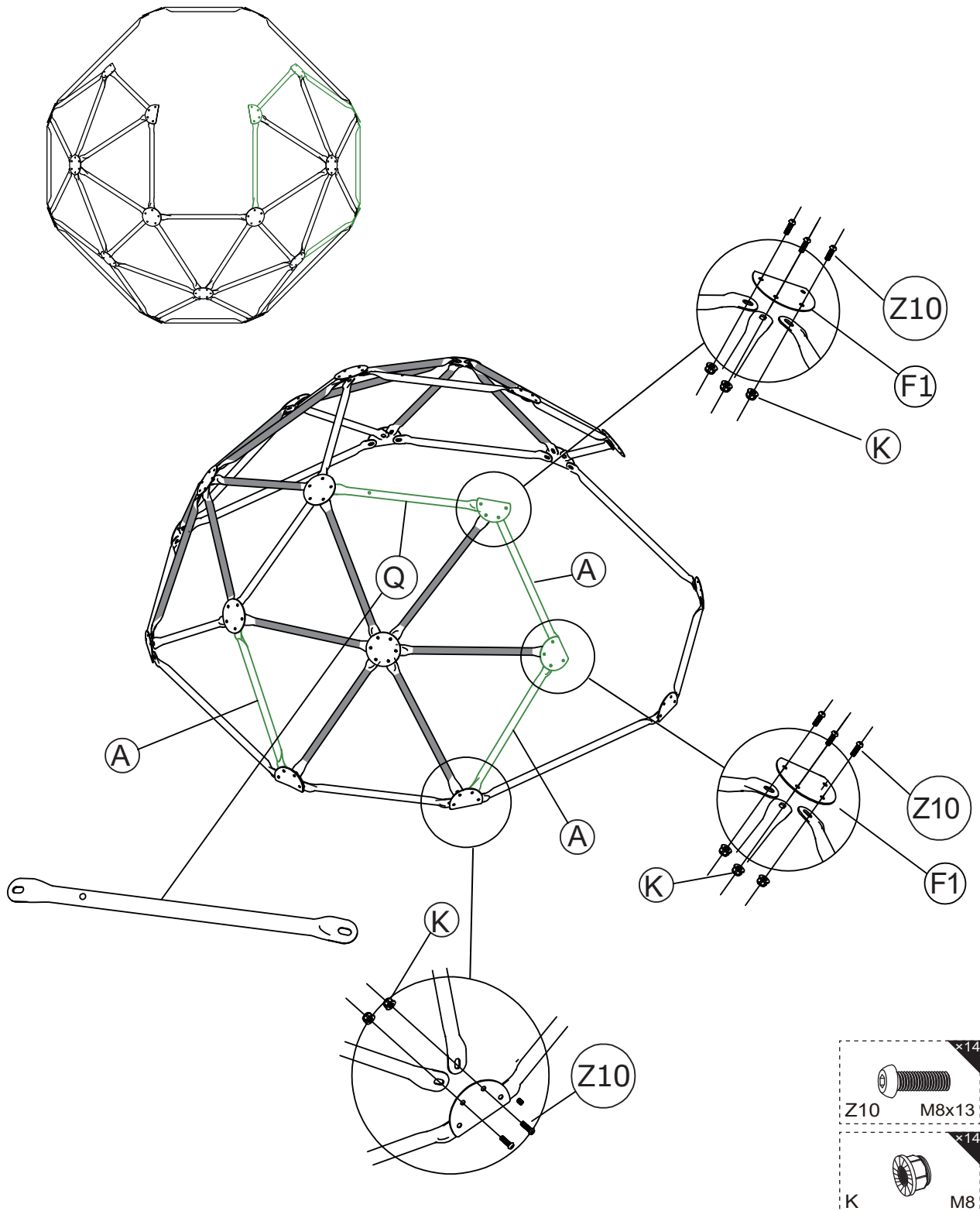



Use F1, A, and Q to connect the assembly parts(\*) in the first step. Pay attention to the direction when installing Q. The middle hole is located near the left side of the picture.

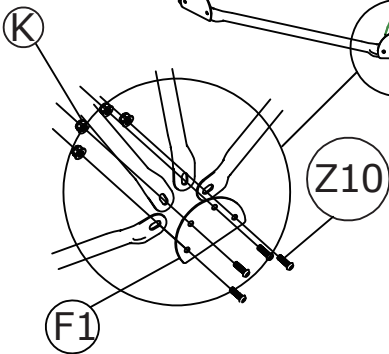
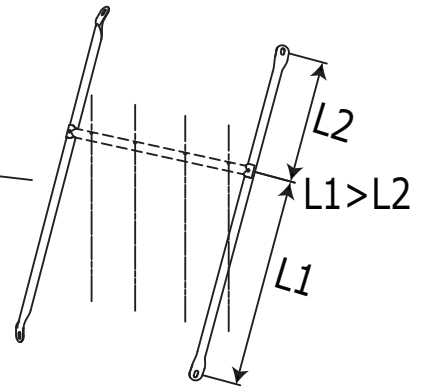
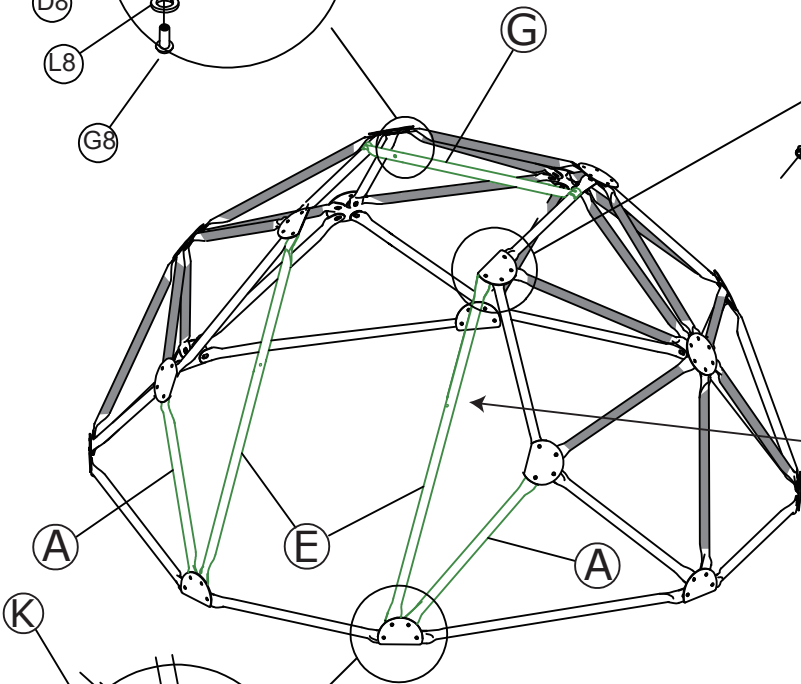
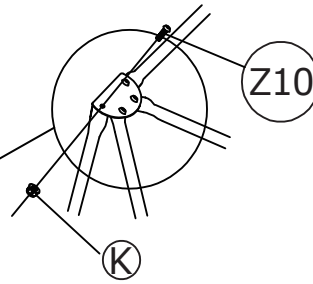
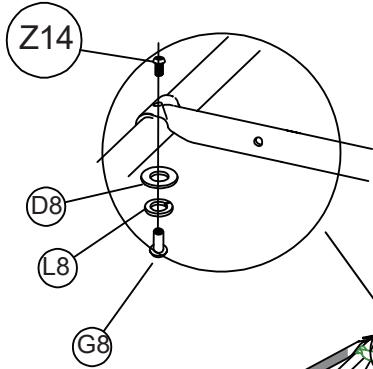
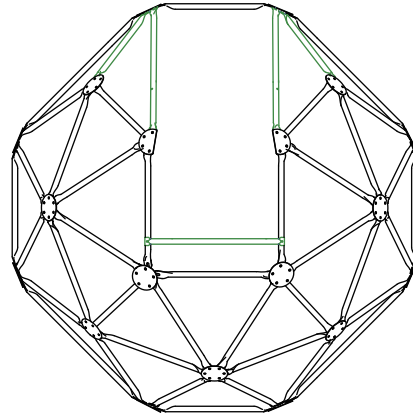

6

When connecting A, E, H, G, and H, all holes should face upward, and the short side of the middle hole of E is close to the upper side.



 x2	 x2	 x2
 x8	 x8	 x2

D,H and F need to be passed through the cloth and then screwed on G and H respectively.

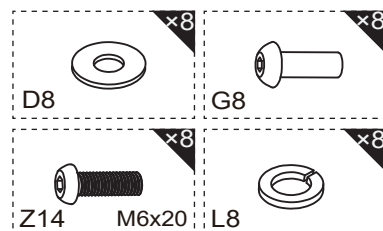
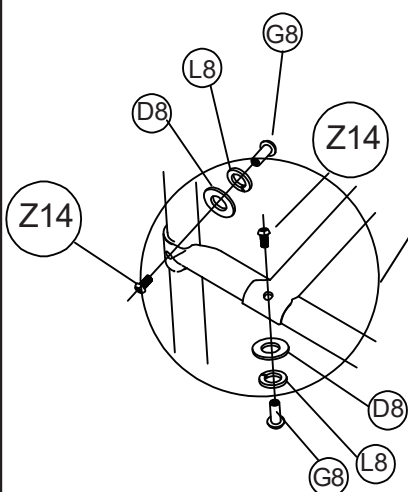
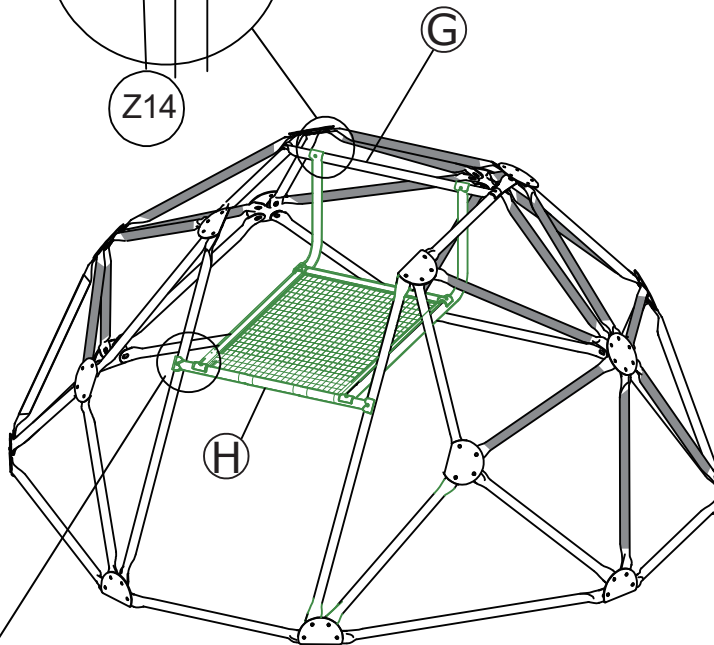
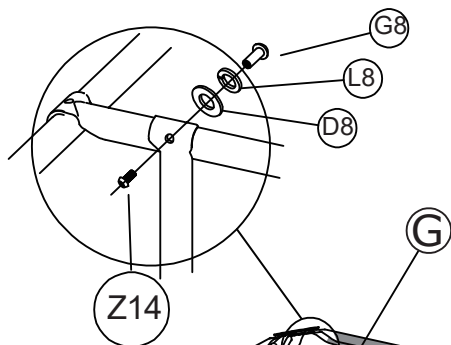
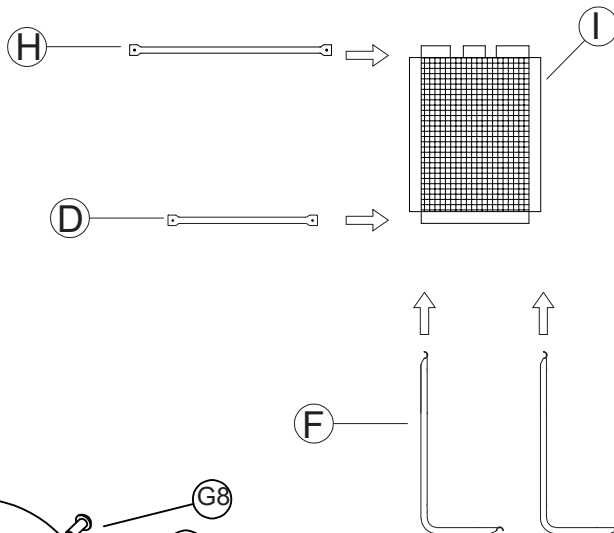
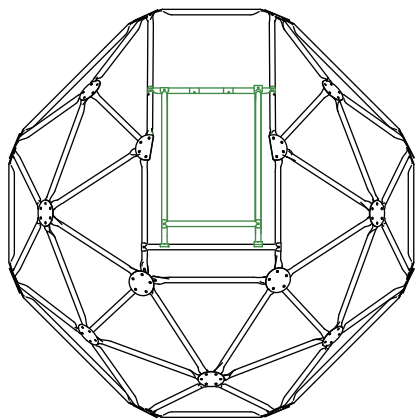

Install the slider to H and tighten the screws.

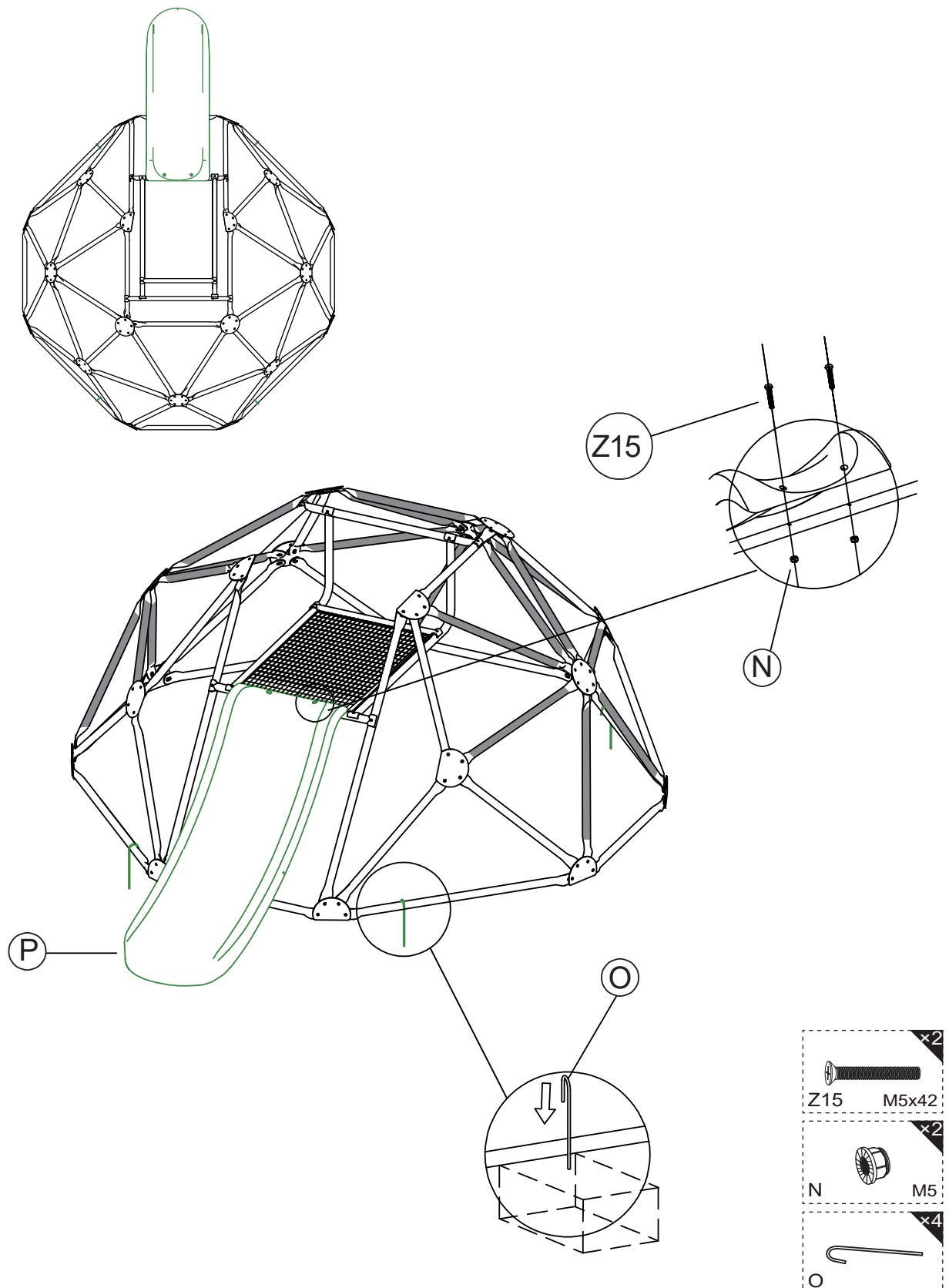

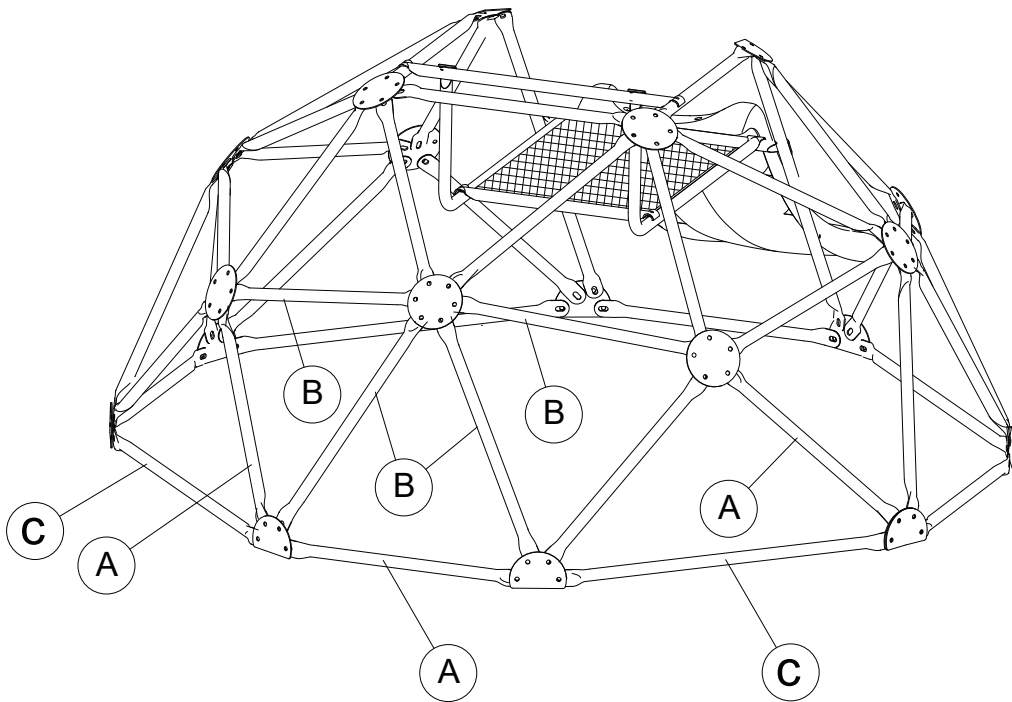
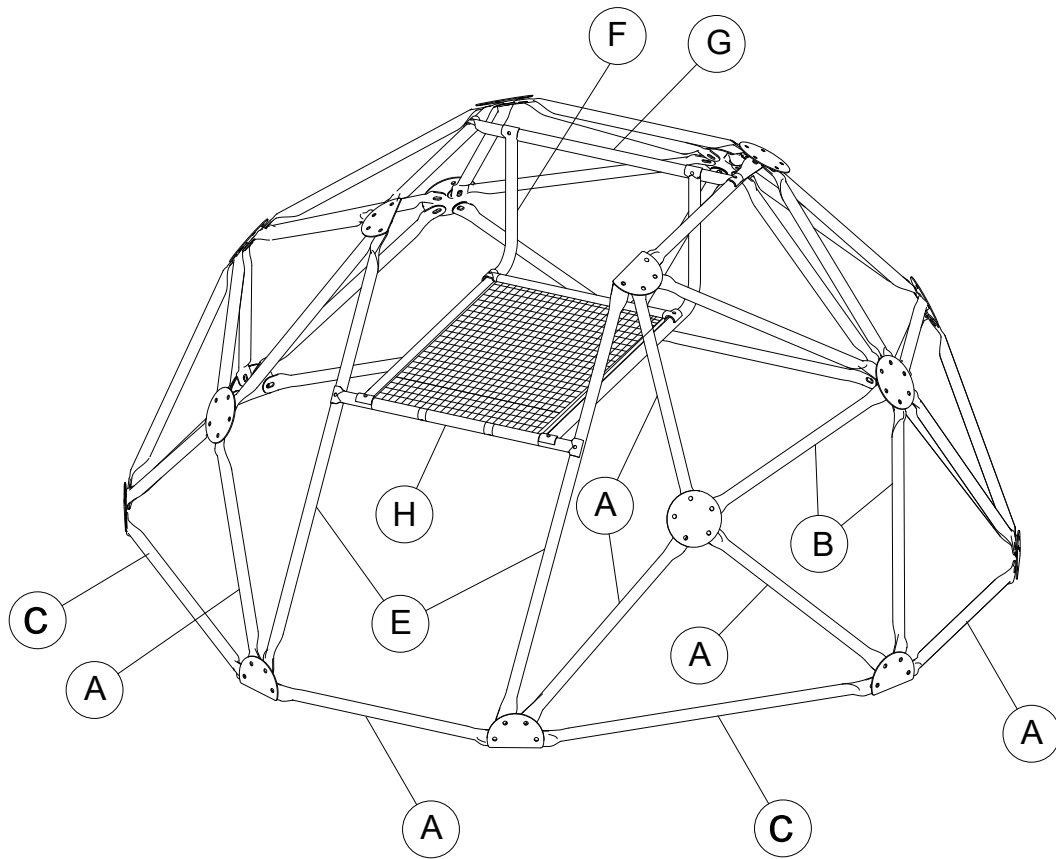

**Note:** Tighten all screws after all assembly is complete.

## **ASSEMBLY INSTRUCTIONS**

To be retained for future reference.

**WARNING:** Only for residential outdoor and indoor use.

### **Dear Customer,**

To guarantee safety, please give special attention to the assembly, safety and care instructions detailed in this document.

### **ASSEMBLY ADVICE**

Please follow the assembly instructions exactly as given.

- 1) This product must be assembled by an adult.
- 2) Keep a copy of your assembly instructions for future reference. This can be particularly handy for identification of parts if any after-sales service is required.
- 3) Before commencing, check that none of the parts are missing. If you find that you are missing a part, please contact our after-sales service department.
- 4) Dispose of packaging thoughtfully.
- 5) Do not allow children to play with packaging.
- 6) We advise that the slide is not faced towards the sun.

### **SAFETY ADVICE**

- 1) This product must not be used by children under the age of 36 months. It is suitable only for children between the ages of 3 and 12 years with a maximum weight of 50kg. It must be used under adult supervision. Maximum 3 children can use it at the same time.
- 2) As this product contains small parts that could be swallowed, please keep parts away from children under 36 months.
- 3) This product is only for private use at home and must never be used in parks and public gardens, in schools, camp sites, hotels, public leisure areas, etc.

- 4) This product should be set up on a flat surface 2 m away from all other things, structures or obstacles (walls, fences, trees, washing lines or electric cables etc.) that could cause injury during use.
- 5) This product must not be set up over hard surfaces such as concrete, asphalt or other hard surfaces. We recommend installation over grass or other such soft surfaces.
- 6) This product must be embedded firmly into the ground. Please follow the instructions carefully for doing so. Only use this product when the concrete is dry.
- 7) Anchors should be placed level with or below ground level in order to reduce tripping hazards.
- 8) The anchorage must be checked regularly, in addition to the hooks and fixtures.
- 9) Dispose of packaging thoughtfully.
- 10) Do not allow children to play with packaging.
- 11) During the assembly, keep children away from the toy to avoid child swallow the small accessories.

## **MAINTENANCE**

- 1) All metal parts are galvanized steel and powder coated for rust protection.  
However, in certain areas close to the sea, we advise that additional rust prevention treatment may be necessary.
- 2) The surfaces of all the parts should be checked at least once a month, especially for the fixtures such as hooks on the overhead beam. If the fixtures and hooks show wear over 10% of their original thickness, then they should be replaced with the same fixtures as those originally provided.
- 3) To check all nuts and bolts for tightness and tighten when required.
- 4) To check all coverings for bolts and sharp edges and replace when required.

- 5) Toys may collapse or be dangerous if they don't check regularly.
- 6) The ground on which the product is placed should be controlled regularly. All elements such as stones or other objects that could cause injury in the case of a fall should be removed. It is advised to remove the apparatus during the winter period or when not in use, to avoid any deterioration due to bad weather conditions.
- 7) All used apparatuses and/or parts must be replaced by a part delivered by our after-sales service.
- 8) Any modifications made by consumer to the original activity toy shall be carried out according to the instructions of the manufacturer.
- 9) Sand rusted areas and tubular members, and repaint using a non-lead based paint when required.

### **PRACTICAL ADVICE**

Safety checks should be carried out regularly on this product. These checks should include, if necessary, removing any sharp edges, replacing missing screw covers, and tightening the nuts and bolts. These checks should be done to avoid any danger or upturning through normal wear and tear.

### **IMPORTANT!**

Wait until the concrete is set before using your slide and check anchorages regularly. Children should not jump hard on the slide.

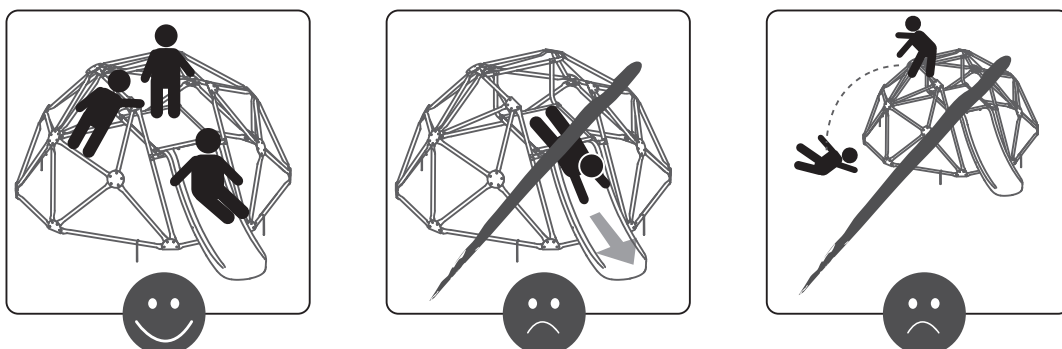

Contact person  
tectake Ltd.  
Mappin House  
4 Winsley Street  
W1W 8HF London ,UK  
Telephone: +44 203488 4565  
www. tectake.co.uk  
mail@tectake.co.uk

# Kletterkuppel mit Rutsche

ENTSPRICHT DEN SICHERHEITSANFORDERUNGEN

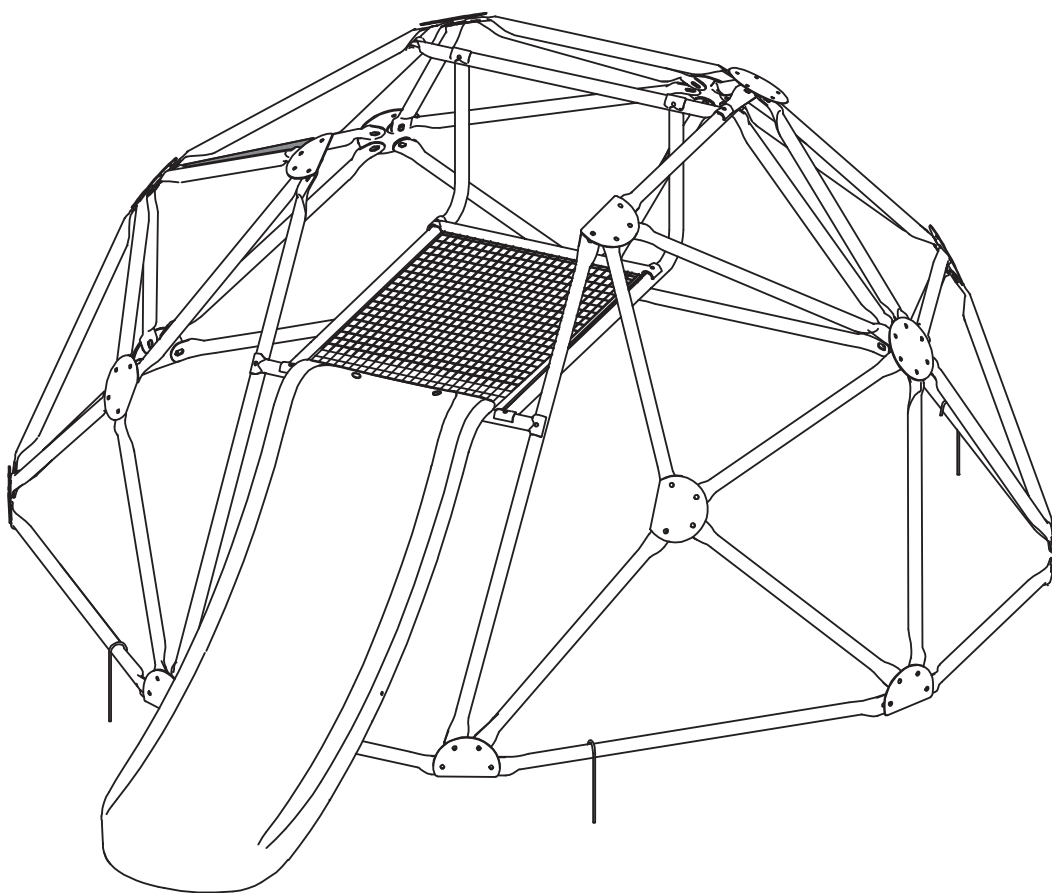





**ORIGINAL BEDIENUNGSANLEITUNG**  
**Bewahren Sie sie zum späteren Nachschlagen auf**







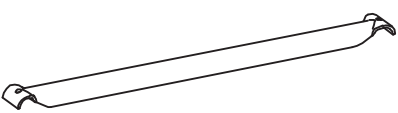

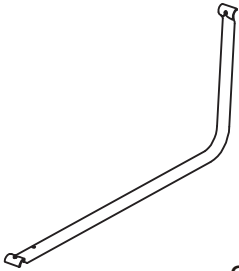

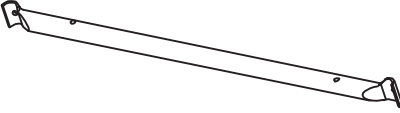

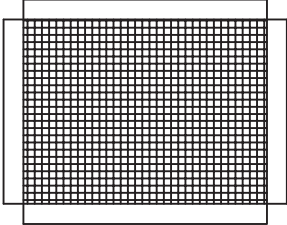
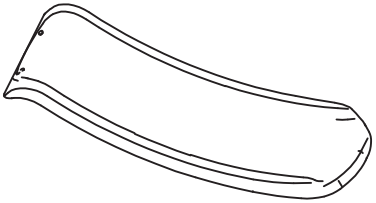
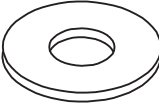
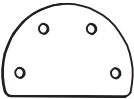
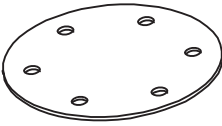
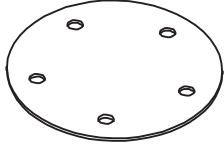
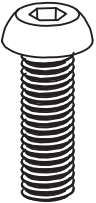
- ⚠ Gefahr! Halten Sie alle kleinteile und Verpackungsmaterialien fern von Babys und Kindern, ansonsten besteht Erstickungsgefahr.
- ⚠ Der Artikel muss unter der Aufsicht eines Erwachsenen montiert und benutzt werden.
- ⚠ Lesen Sie jeden Schritt sorgfältig durch und befolgen Sie die richtige Reihenfolge.
- ⚠ Entfernen Sie alle Verpackungen, Überprüfen Sie, ob alle Teile und Zubehörteile vorhanden sind.
- ⚠ Bitte stellen Sie sicher, dass alle Teile richtig montiert sind, eine falsche Montage kann zu einer Gefahr führen.
- ⚠ Wir empfehlen, alle Teile möglichst in der Nähe des Aufstellungsortes zu montieren, um unnötige Bewegungen nach der Montage zu vermeiden.
- ⚠ Achten Sie bei der Montage auf einen sicheren Untergrund und stellen Sie den Artikel immer auf eine ebene, feste und stabile Fläche.

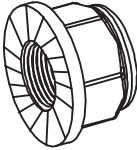
## STÜCKLISTE

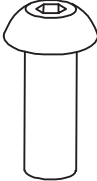
**Hinweis:** Für einige dieser Teile gibt es zusätzliche Ersatzteile.

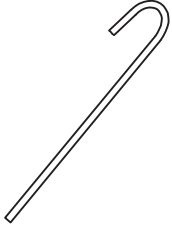
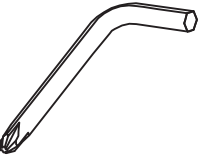
<p><b>A</b></p>  <p>Blau 17pcs</p>	<p><b>B</b></p>  <p>rot 18pcs</p>	<p><b>C</b></p>  <p>Blau 4pcs</p>
<p><b>D</b></p>  <p>Blau 1pc</p>	<p><b>E</b></p>  <p>Blau 2pcs</p>	<p><b>F</b></p>  <p>Blau 2pcs</p>

<p><b>G</b></p>  <p>Blau 1pc</p>	<p><b>H</b></p>  <p>Blau 1pc</p>	<p><b>Q</b></p>  <p>Blau 2pcs</p>	
<p><b>I</b></p>  <p>1pc</p>	<p><b>P</b></p>  <p>1pc</p>	<p><b>D8</b></p>  <p>10pcs</p>	
<p><b>F1</b></p>  <p>12pcs</p>	<p><b>F2</b></p>  <p>3pcs</p>	<p><b>F3</b></p>  <p>4pcs</p>	
<p><b>Z10</b></p>  <p>M8x13 86pcs</p>	<p><b>Z14</b></p>  <p>M6x20 10pcs</p>	<p><b>Z15</b></p>  <p>M5x42 2pcs</p>	
<p><b>K</b></p>  <p>M8 86pcs</p>	<p><b>N</b></p>  <p>M5 2pcs</p>	<p><b>G8</b></p>  <p>10pcs</p>	
<p><b>L8</b></p>  <p>10pcs</p>	<p><b>O</b></p>  <p>4pcs</p>	<p><b>A5</b></p>  <p>2pcs</p>	<p><b>K1013</b></p>  <p>1pc</p>

# MONTAGE

1

Montieren Sie zunächst die 3 Teile in Form von (\*), die in der Abbildung dargestellt sind, um sie in den folgenden Installationsschritten zu verwenden. Die grünen Linien stellen die Teile dar, die für die aktuelle Installation benötigt werden.

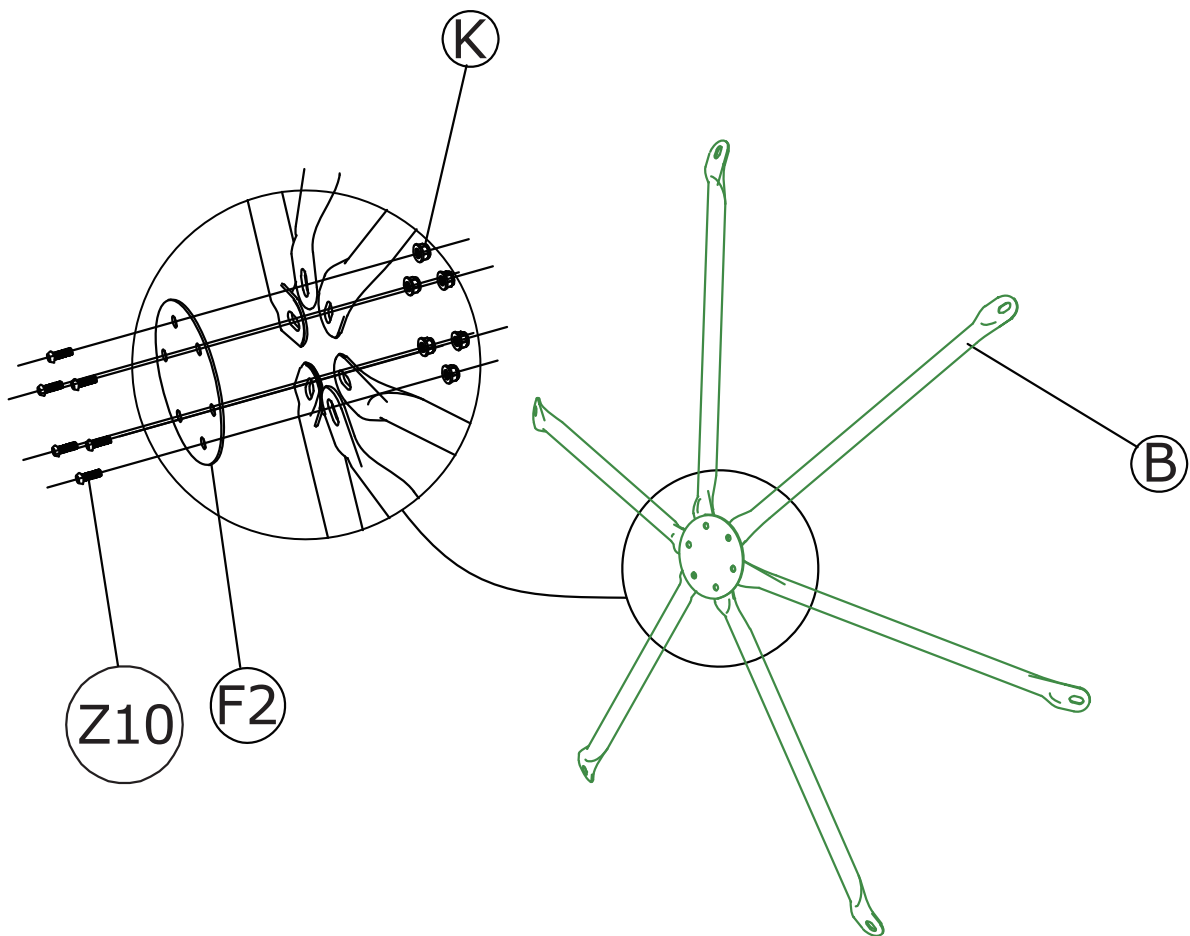

×3

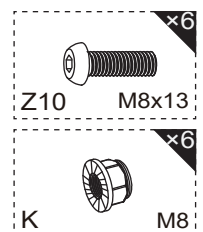

Verbinden Sie mit F1 abwechselnd A und C, um ein Achteck zu bilden.

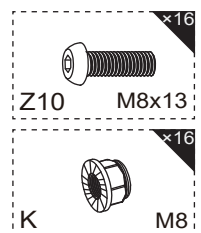
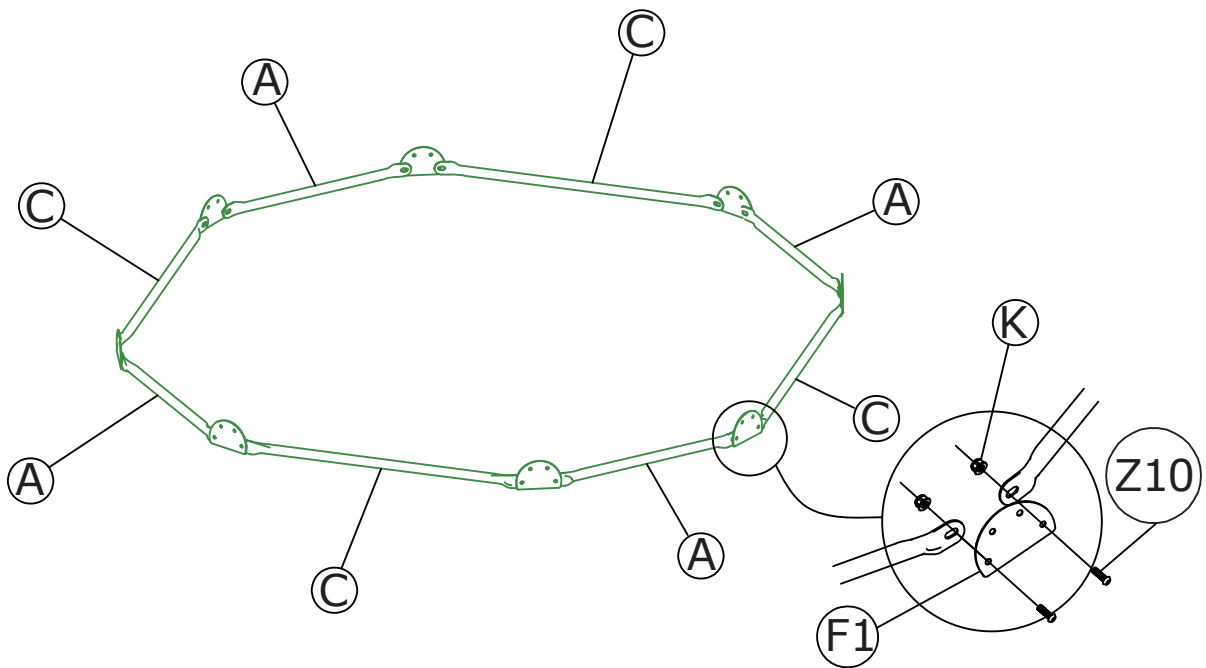
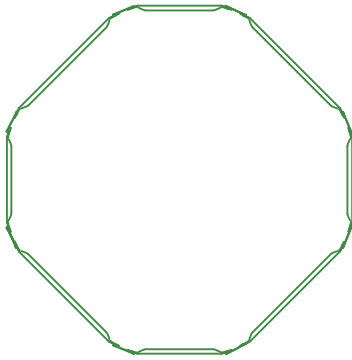

3

Benutzen Sie F1, F3, A und Q, um die Teile (\*) aus dem ersten Schritt zu einem Sechseck zu verbinden.

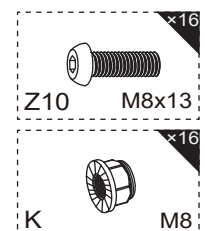
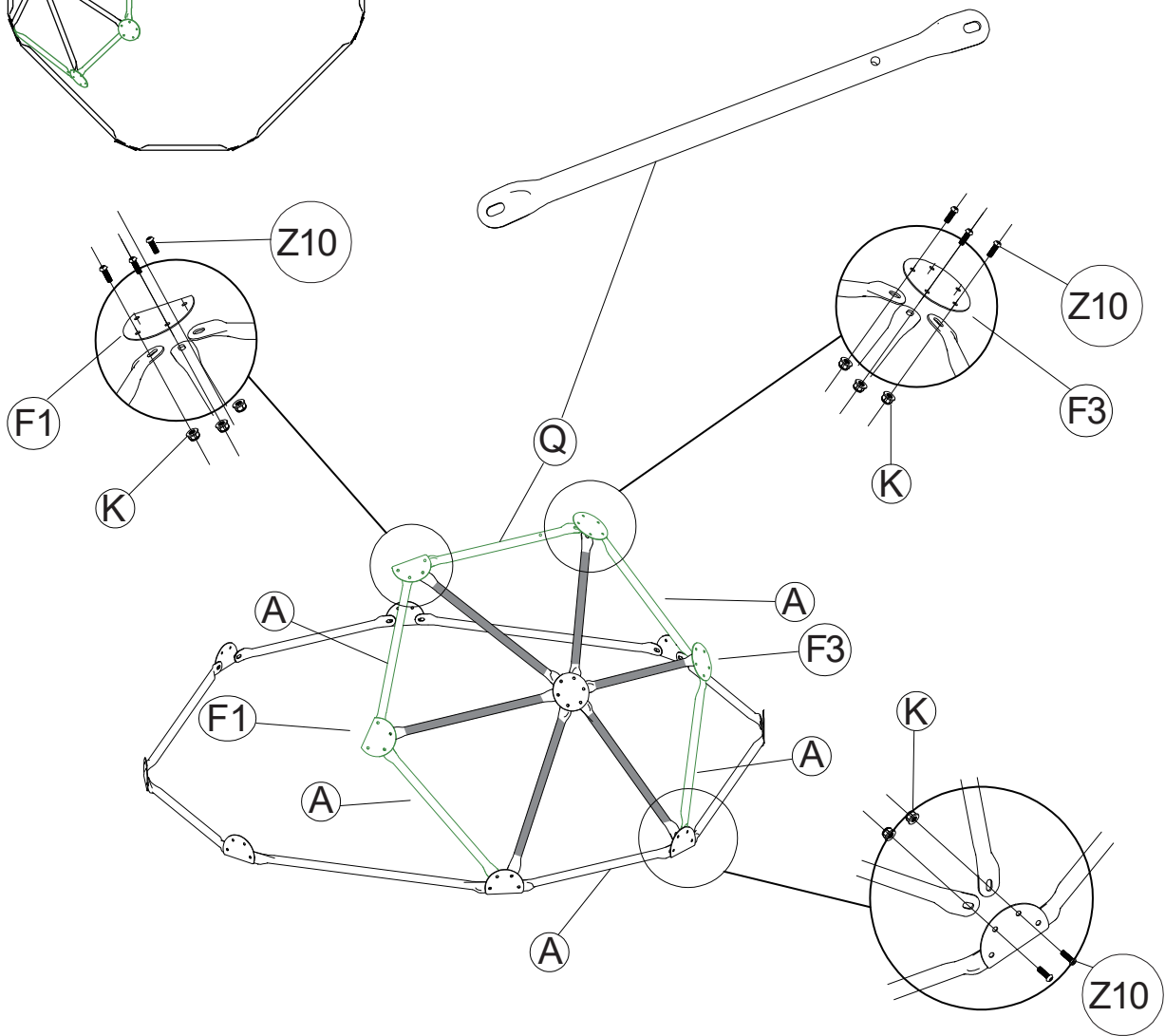
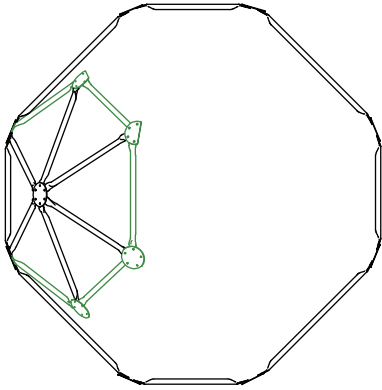

4

Verwenden Sie A und F3, um die Montageteile (\*) im ersten Schritt so zu verbinden, dass die in der Abbildung gezeigte Struktur entsteht.

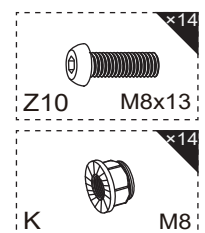
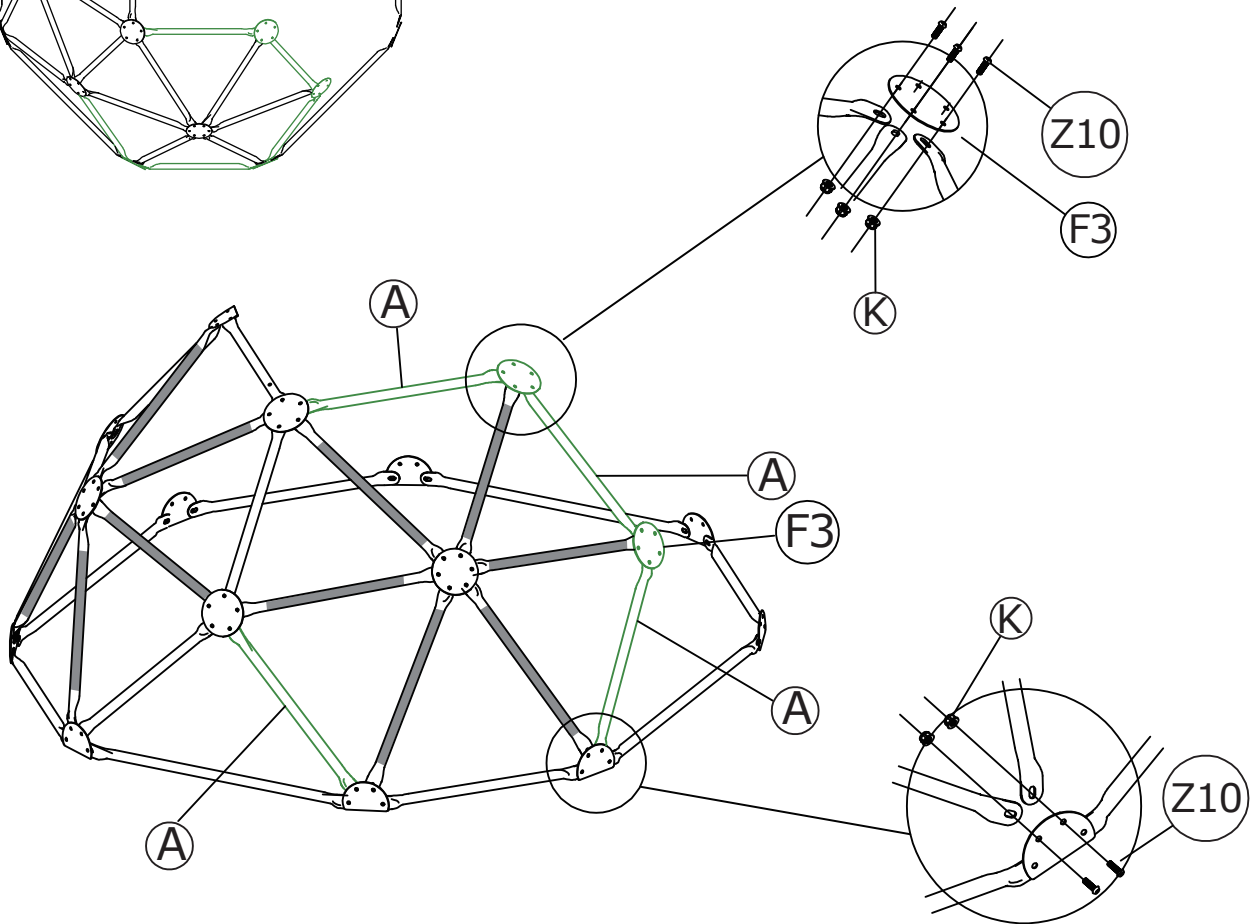
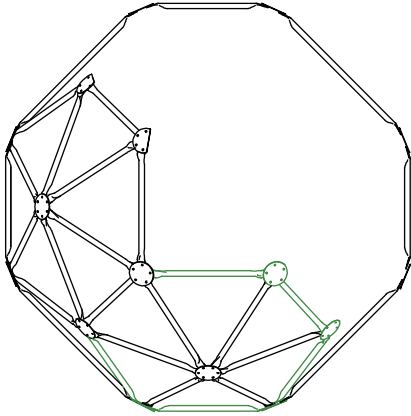

5

Verwenden Sie F1, A und Q, um die Montageteile (\*) im ersten Schritt zu verbinden. Achten Sie beim Einbau von Q auf die Richtung. Das mittlere Loch befindet sich in der Nähe der linken Seite des Bildes.

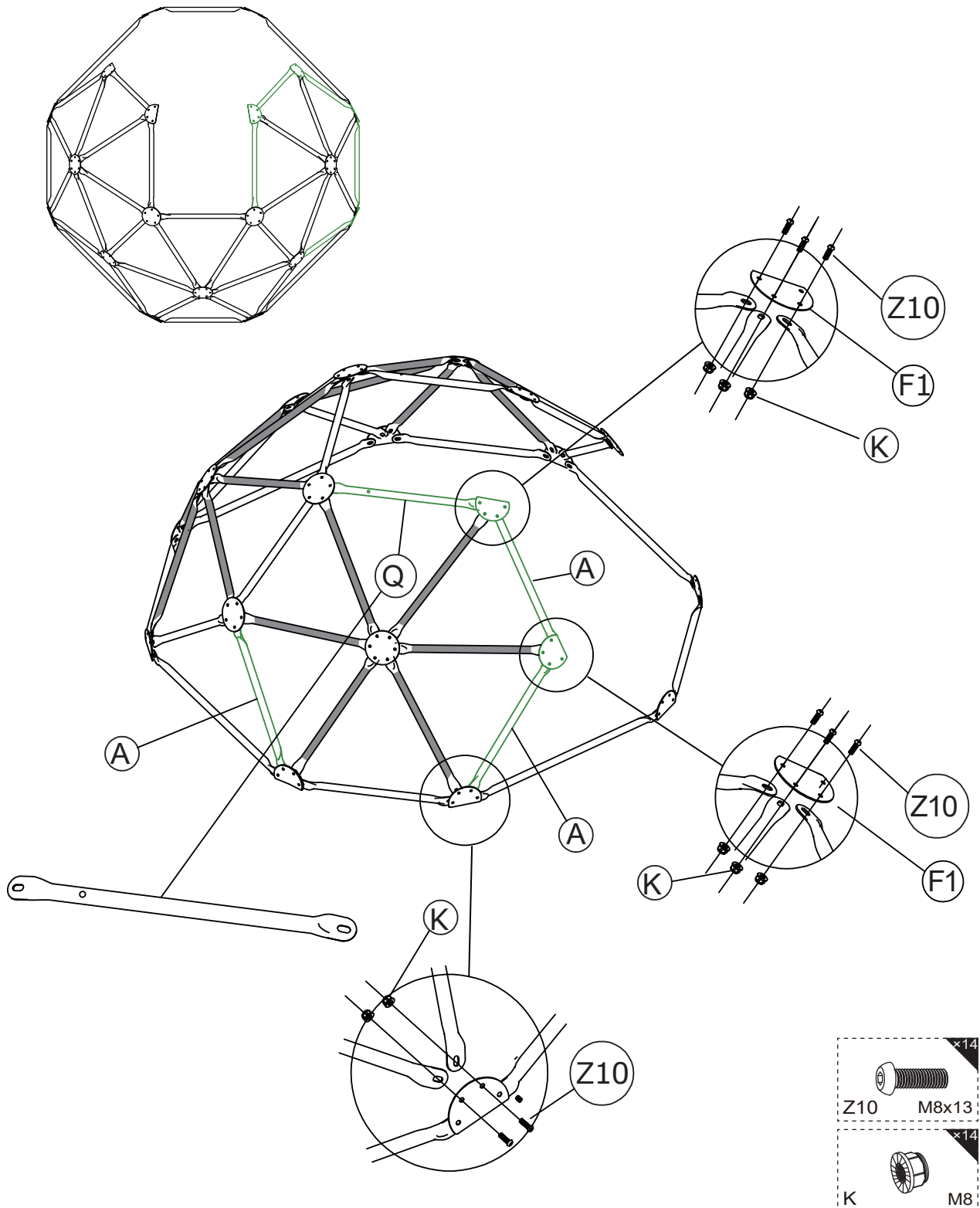

6

Beim Verbinden von A, E, H, G und H sollten alle Löcher nach oben zeigen, und die kurze Seite des mittleren Lochs von E befindet sich in der Nähe der oberen Seite.

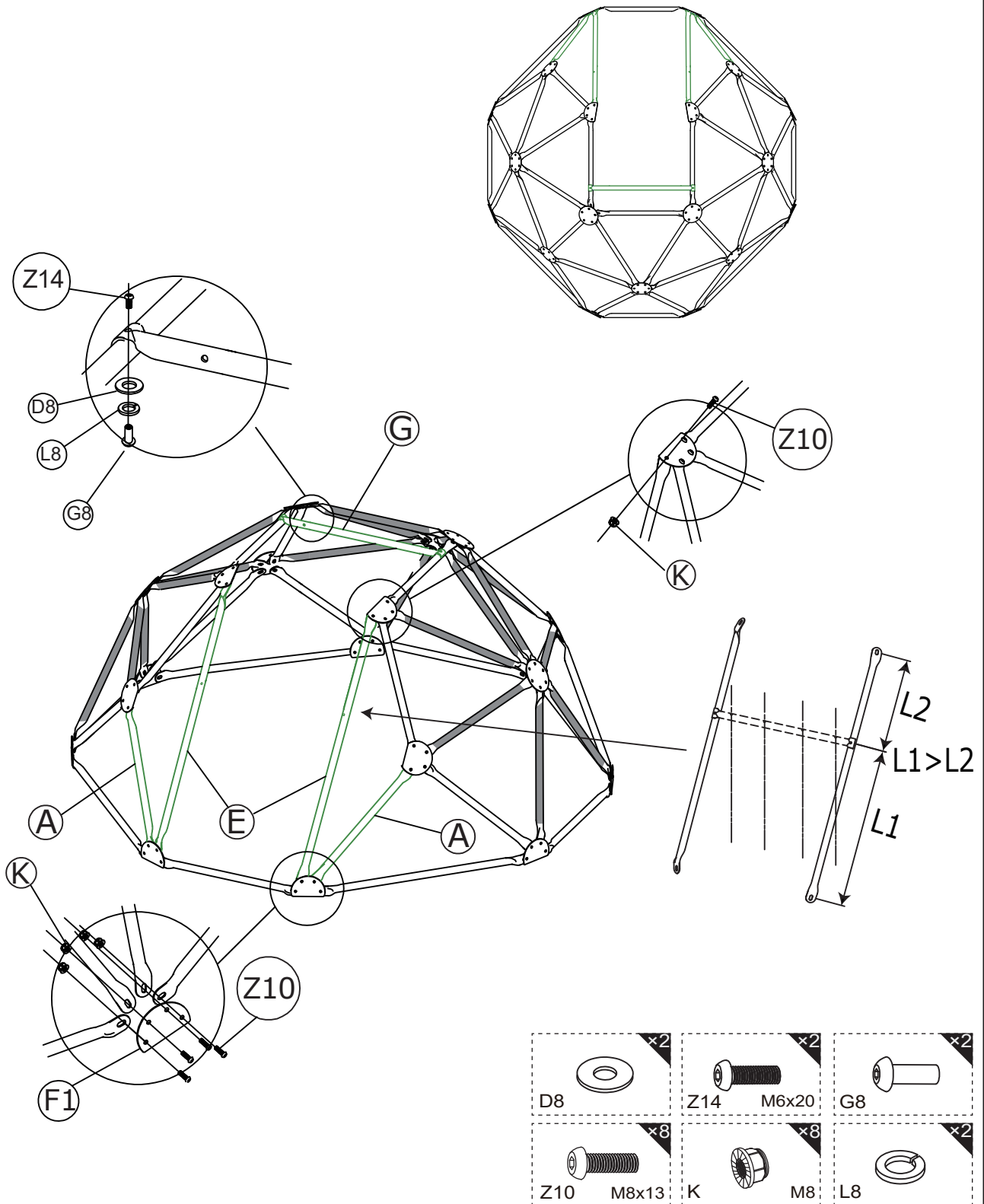

D,H und F müssen durch den Stoff geführt und dann auf G bzw. H geschraubt werden.

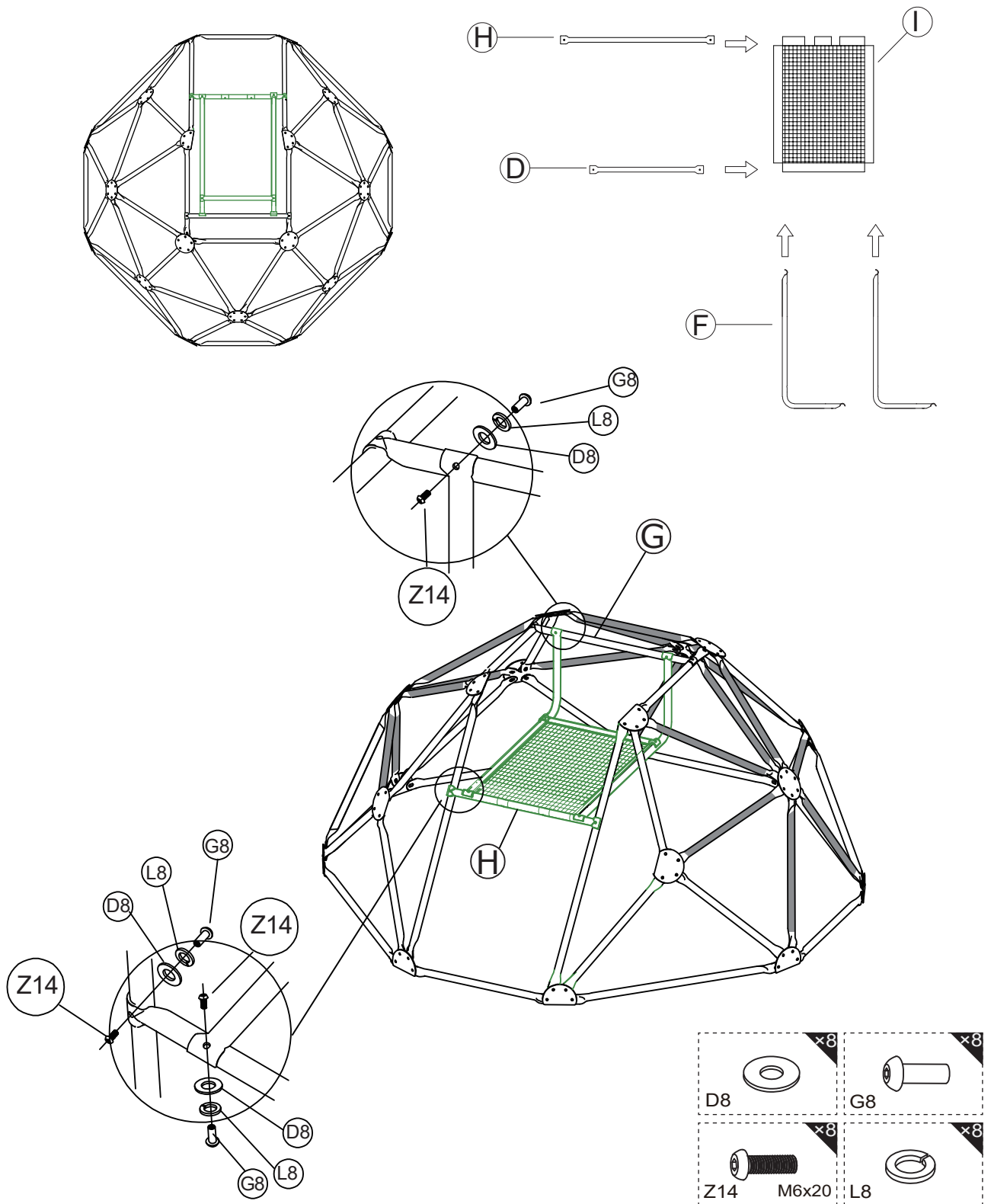

Bringen Sie die Rutsche an H an und ziehen Sie die Schrauben fest.

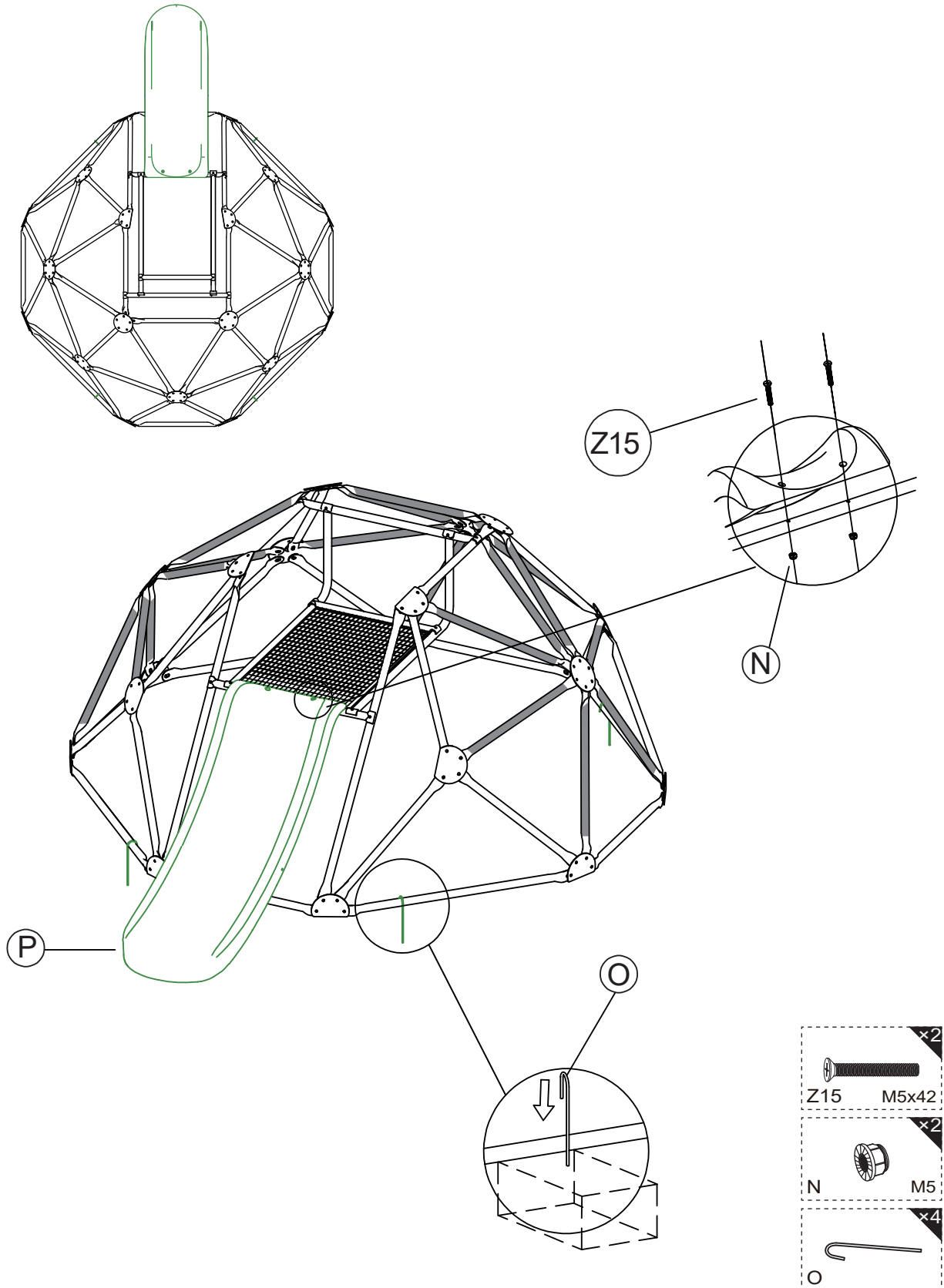

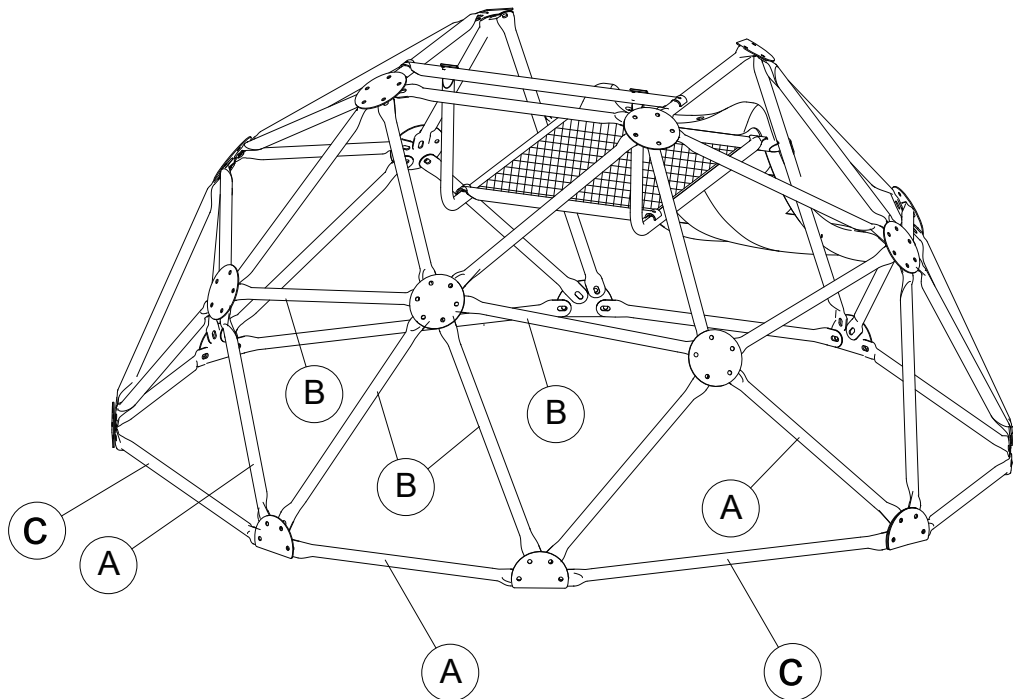
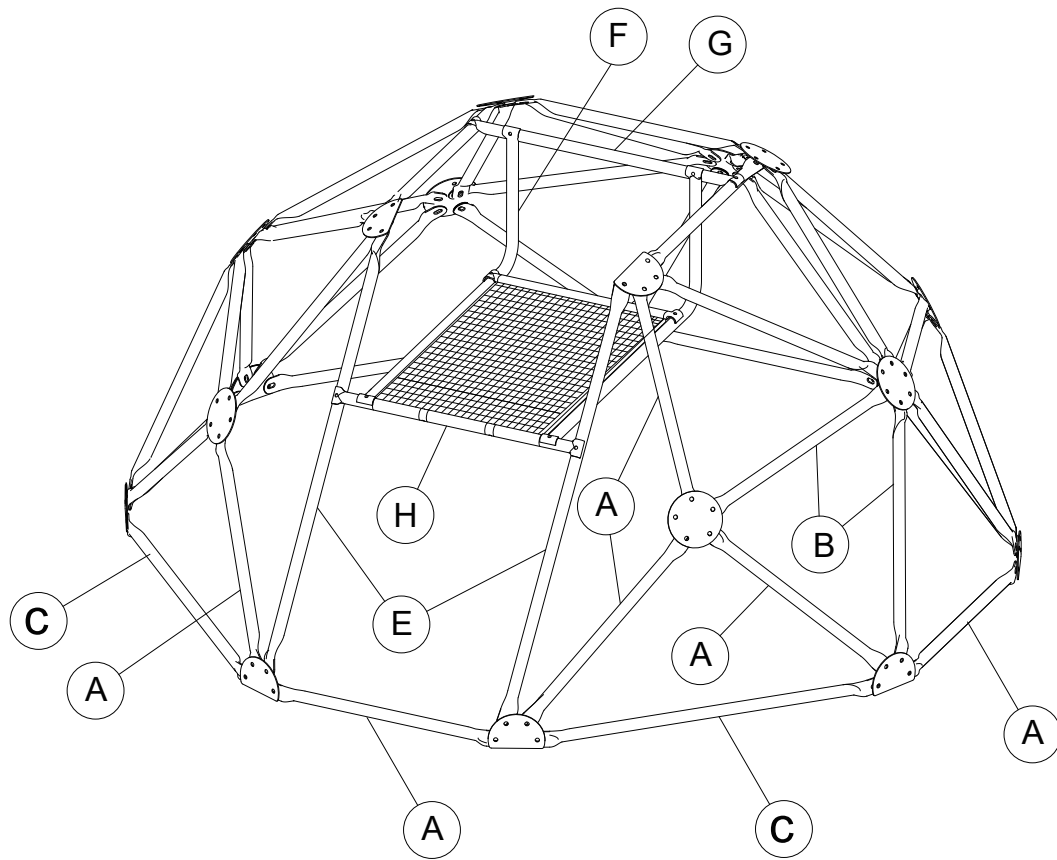

**Hinweis:** Ziehen Sie alle Schrauben nach Abschluss der Montage fest.

## **MONTAGEANLEITUNG**

Zum späteren Nachschlagen aufbewahren.

**ACHTUNG:** Nur für den privaten Gebrauch in Innen- und Außenbereichen.

**Sehr geehrter Kunde,**

um die Sicherheit zu gewährleisten, bitten wir Sie, die in diesem Dokument aufgeführten Montage-, Sicherheits- und Pflegehinweise besonders zu beachten.

### **MONTAGEHINWEISE**

Bitte befolgen Sie die Montageanleitung genau.

- 1) Dieser Artikel muss von einem Erwachsenen zusammengebaut werden.
- 2) Bewahren Sie eine Kopie der Montageanleitung für spätere Nachschlagzwecke auf. Dies kann besonders praktisch sein, um Teile zu identifizieren, falls ein Kundendienst erforderlich ist.
- 3) Vergewissern Sie sich vor dem Zusammenbau, dass keine Teile fehlen. Sollten Sie feststellen, dass ein Teil fehlt, wenden Sie sich bitte an unseren Kundendienst.
- 4) Entsorgen Sie die Verpackung mit Bedacht.
- 5) Lassen Sie Kinder nicht mit der Verpackung spielen.
- 6) Es ist empfohlen, dass die Rutsche nicht der Sonne zugewandt sein sollte.

### **SICHERHEITSHINWEISE**

- 1) Dieser Artikel darf nicht von Kindern unter 36 Monaten verwendet werden. Er ist nur für Kinder im Alter von 3 bis 12 Jahren mit einem Höchstgewicht von 50 kg geeignet. Er muss unter Aufsicht von Erwachsenen benutzt werden. Maximal 3 Kinder können ihn gleichzeitig benutzen.
- 2) Da dieser Artikel Kleinteile enthält, die verschluckt werden könnten, halten Sie bitte Teile von Kindern unter 36 Monaten fern.
- 3) Dieser Artikel ist nur für den privaten Gebrauch zu Hause bestimmt und darf nicht in Parks und öffentlichen Gärten, in Schulen, auf Campingplätzen, in Hotels, öffentlichen Freizeiteinrichtungen usw. verwendet werden.

- 4) Dieser Artikel muss auf einer ebenen Fläche in einem Abstand von 2 m von allen anderen Gegenständen, Strukturen oder Hindernissen (Wand, Zäunen, Bäumen, Wäscheleinen oder Stromkabeln usw.) aufgestellt werden, die während der Benutzung Verletzungen verursachen könnten.
- 5) Dieser Artikel darf nicht auf harten Oberflächen wie Beton, Asphalt oder anderen harten Oberflächen aufgestellt werden. Wir empfehlen die Aufstellung auf Gras oder anderen weichen Oberflächen.
- 6) Dieser Artikel muss fest in den Boden eingelassen werden. Bitte befolgen Sie dazu sorgfältig die Anweisungen. Verwenden Sie diesen Artikel nur, wenn der Beton trocken ist.
- 7) Die Verankerung sollte auf oder unter Bodenniveau erfolgen, um Stolperfallen zu vermeiden.
- 8) Die Verankerung muss regelmäßig überprüft werden, zusätzlich zu den Haken und Vorrichtungen.
- 9) Entsorgen Sie Verpackungen mit Bedacht.
- 10) Erlauben Sie Kindern nicht, mit Verpackungen zu spielen.
- 11) Halten Sie Kinder während der Montage vom Spielzeug fern, um zu verhindern, dass sie die kleinen Zubehörteile verschlucken.

## **WARTUNG**

- 1) Alle Metallteile sind aus verzinktem Stahl und zum Schutz vor Rost pulverbeschichtet. In bestimmten Gebieten in Meeresnähe kann je doch eine zusätzliche Rostschutzbehandlung erforderlich sein.
- 2) Die Oberflächen aller Teile sollten mindestens einmal im Monat überprüft werden, insbesondere die Befestigungen, wie z. B. die Haken am Oberlichtbalken. Wenn die Beschläge und Haken eine Abnutzung von mehr als 10 % ihrer ursprünglichen Dicke aufweisen, sollten sie durch die gleichen Beschläge wie die ursprünglich gelieferten ersetzt werden.
- 3) Alle Muttern und Bolzen auf festen Sitz prüfen und bei Bedarf nachziehen.
- 4) Alle Abdeckungen auf Bolzen und scharfe Kanten überprüfen und bei Bedarf ersetzen.

5) Spielzeug kann zusammenbrechen oder gefährlich sein, wenn es nicht regelmäßig überprüft wird.

6) Der Boden, auf dem der Artikel platziert wird, sollte regelmäßig kontrolliert werden. Alle Elemente wie Steine oder andere Gegenstände, die im Falle eines Sturzes Verletzungen verursachen könnten, sollten entfernt werden. Es wird empfohlen, die Geräte im Winter oder bei Nichtgebrauch zu entfernen, um eine Verschlechterung durch schlechte Witterungsbedingungen zu vermeiden.

7) Alle gebrauchten Geräte und/oder Teile müssen durch ein von unserem Kundendienst geliefertes Ersatzteil ersetzt werden.

8) Alle vom Verbraucher vorgenommenen Änderungen am Originalspielzeug müssen gemäß den Anweisungen des Herstellers durchgeführt werden.

9) Rostige Stellen und Rohre müssen abgeschliffen und bei Bedarf mit bleifreier Farbe neu lackiert werden.

### **PRAKTISCHE RATSCHLÄGE**

Dieser Artikel sollte regelmäßig einer Sicherheitsprüfung unterzogen werden. Dazu gehört, dass gegebenenfalls scharfe Kanten entfernt, fehlende Schraubenabdeckungen ersetzt und Muttern und Bolzen nachgezogen werden. Diese Kontrollen sollten durchgeführt werden, um eine Gefährdung oder ein Umkippen durch normale Abnutzung zu vermeiden.

### **WICHTIG!**

Warten Sie, bis der Beton ausgehärtet ist, bevor Sie Ihre Rutsche benutzen, und überprüfen Sie die Verankerungen regelmäßig. Kinder sollten nicht mit voller Wucht auf der Rutsche springen.

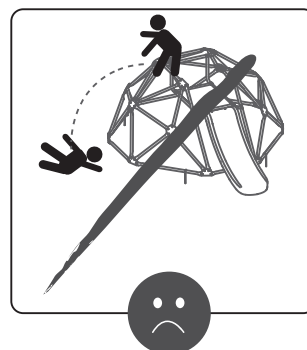
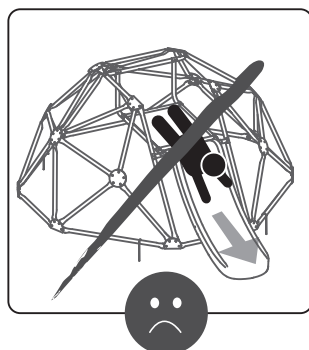
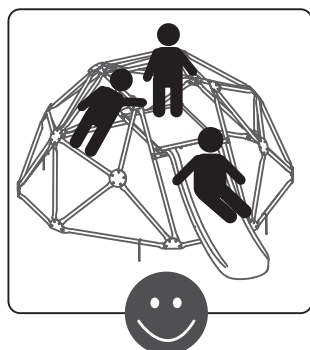

Ansprechpartner  
tectake GmbH  
Tauberweg 41  
97999 Igersheim  
Telefon: +49 7931 991 920  
www.tectake.de  
E-Mail: verkauf@tectake.de

# Dôme d'Escalade pour Enfants avec Toboggan

## CONFORME AUX EXIGENCES DE SECURITE

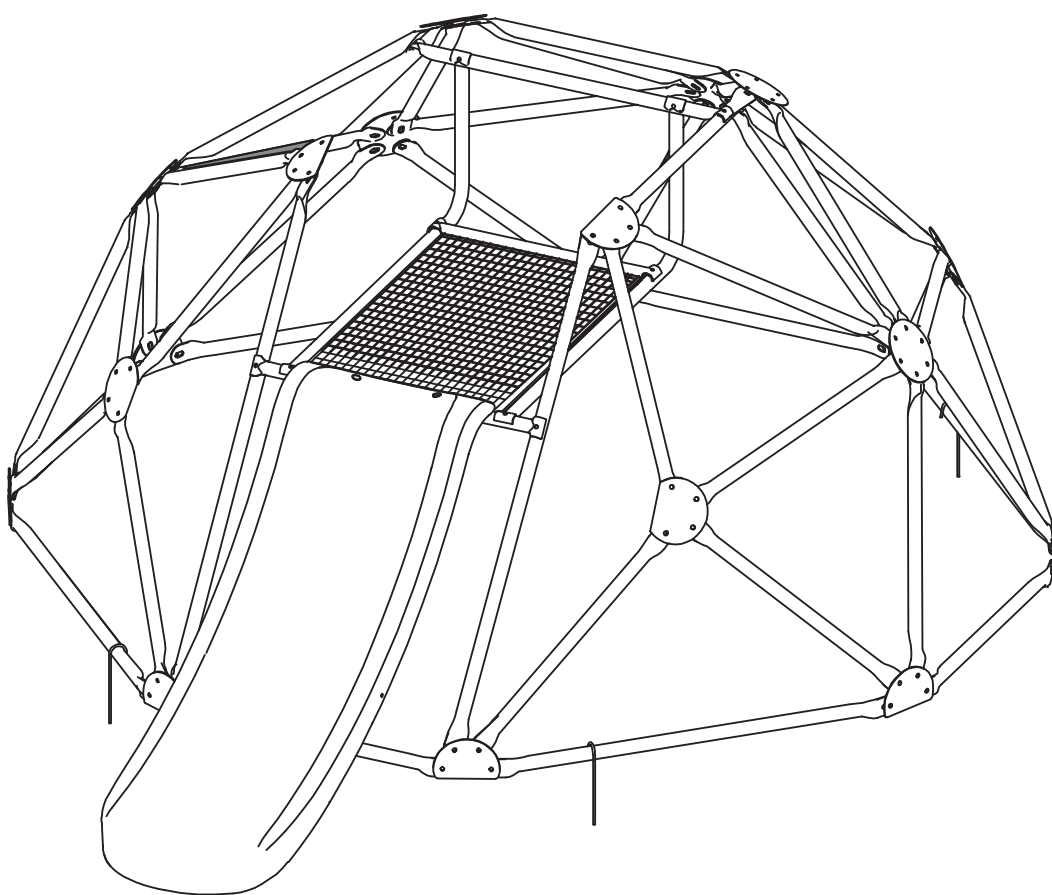





**MANUEL D'INSTRUCTIONS ORIGINAL  
À CONSERVER POUR RÉFÉRENCE ULTÉRIEURE**





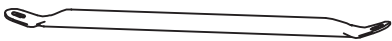

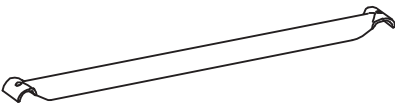

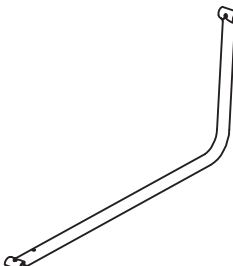

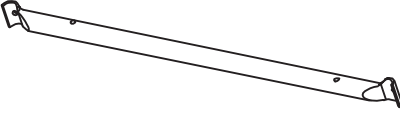
- ⚠ Danger ! Éloignez toutes les petites pièces et le matériel d'emballage des bébés et des enfants pour éviter un risque d'étouffement.
- ⚠ Le produit doit être installé et utilisé sous la surveillance d'un adulte.
- ⚠ Lisez attentivement chaque étape et suivez le bon ordre.
- ⚠ Retirez tous les emballages, séparez et comptez toutes les pièces et le matériel avant l'installation.
- ⚠ Assurez-vous que toutes les pièces sont correctement installées, une installation incorrecte peut entraîner un danger.
- ⚠ Nous recommandons que, dans la mesure du possible, tous les articles soient assemblés à proximité de la zone dans laquelle ils seront utilisés, afin d'éviter de déplacer inutilement le produit une fois assemblé.
- ⚠ Assurez une surface sûre pendant l'assemblage et placez le produit toujours sur une surface plane et stable.

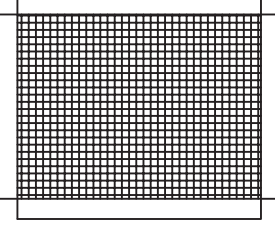
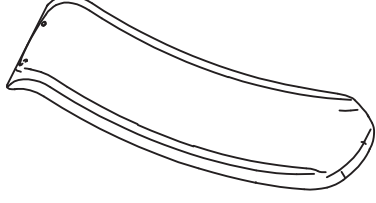
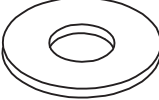
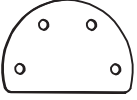
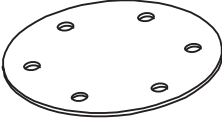
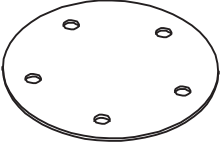
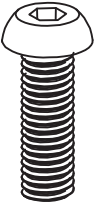
## PARTS LIST

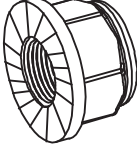
**Remarque:** Certaines de ces pièces ont des pièces de rechange supplémentaires.

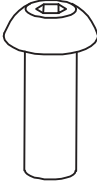
<p><b>A</b></p>  <p>bleu 17pcs</p>	<p><b>B</b></p>  <p>rouge 18pcs</p>	<p><b>C</b></p>  <p>bleu 4pcs</p>
<p><b>D</b></p>  <p>bleu 1pc</p>	<p><b>E</b></p>  <p>bleu 2pcs</p>	<p><b>F</b></p>  <p>bleu 2pcs</p>

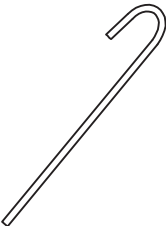
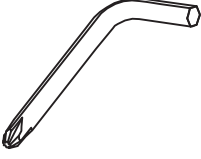
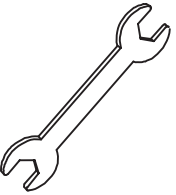
<p><b>G</b></p>  <p>bleu 1pc</p>	<p><b>H</b></p>  <p>bleu 1pc</p>	<p><b>Q</b></p>  <p>bleu 2pcs</p>	
<p><b>I</b></p>  <p>1pc</p>	<p><b>P</b></p>  <p>1pc</p>	<p><b>D8</b></p>  <p>10pcs</p>	
<p><b>F1</b></p>  <p>12pcs</p>	<p><b>F2</b></p>  <p>3pcs</p>	<p><b>F3</b></p>  <p>4pcs</p>	
<p><b>Z10</b></p>  <p>M8x13 86pcs</p>	<p><b>Z14</b></p>  <p>M6x20 10pcs</p>	<p><b>Z15</b></p>  <p>M5x42 2pcs</p>	
<p><b>K</b></p>  <p>M8 86pcs</p>	<p><b>N</b></p>  <p>M5 2pcs</p>	<p><b>G8</b></p>  <p>10pcs</p>	
<p><b>L8</b></p>  <p>10pcs</p>	<p><b>O</b></p>  <p>4pcs</p>	<p><b>A5</b></p>  <p>2pcs</p>	<p><b>K1013</b></p>  <p>1pc</p>

# ASSEMBLAGE

1

Assemblez d'abord les 3 pièces en forme de (\*) indiquées dans la figure pour les utiliser dans les étapes suivantes de l'installation. Les lignes vertes représentent les pièces nécessaires à l'installation actuelle.

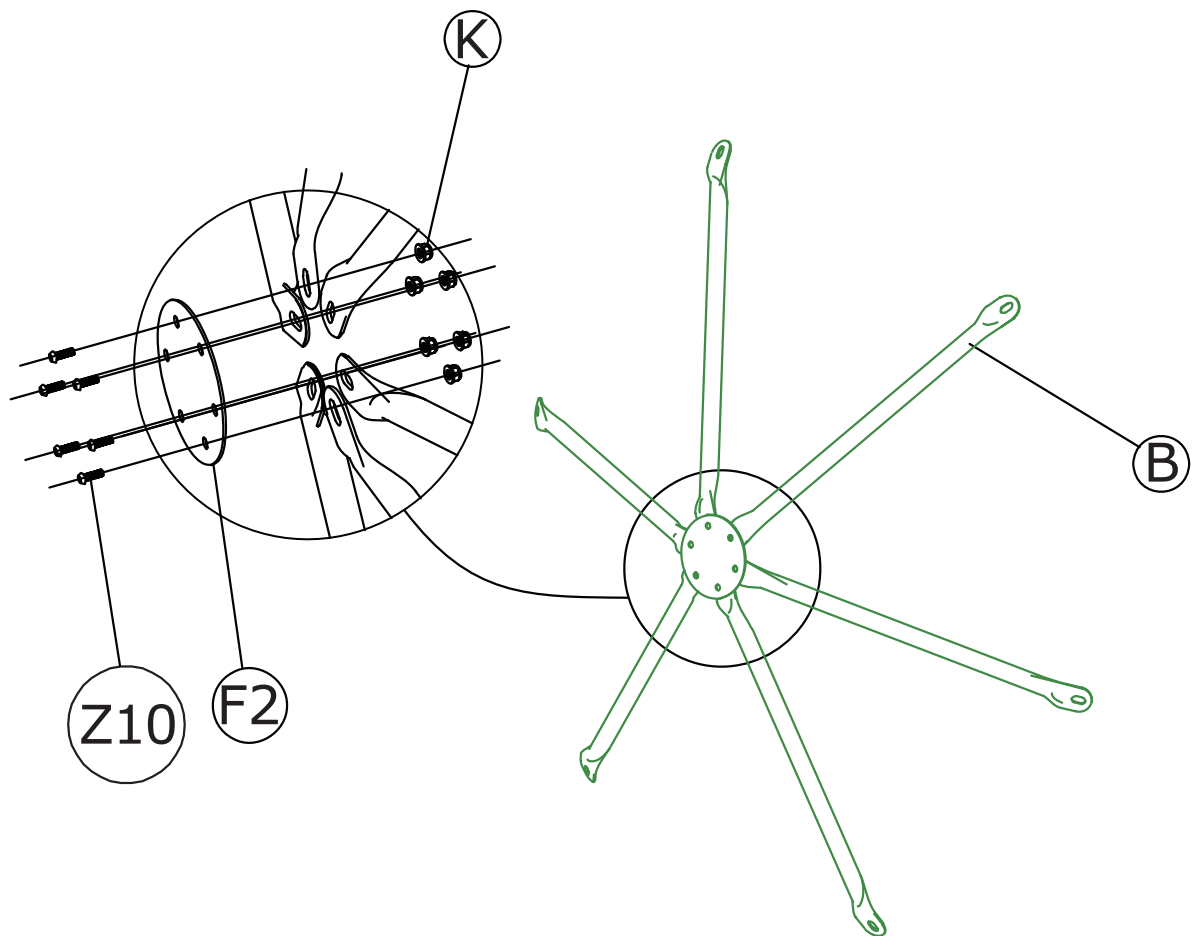

×3

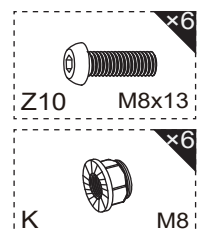

Utilisez F1 pour relier alternativement A et C afin de former un octogone.

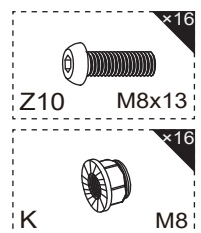
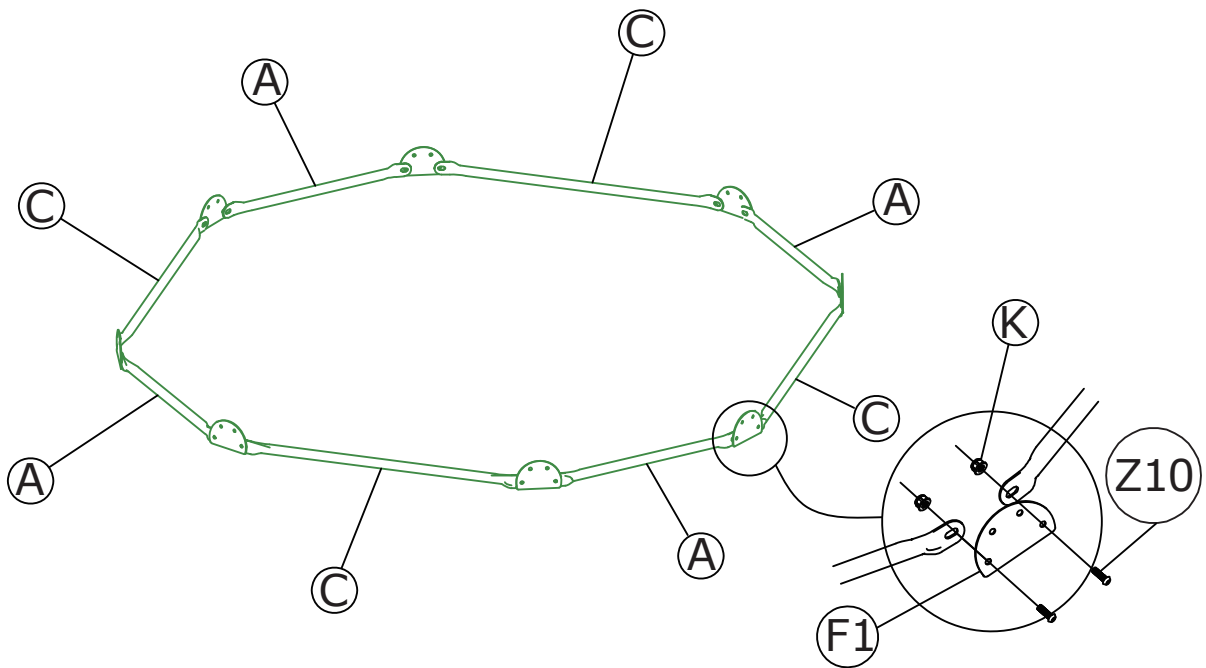
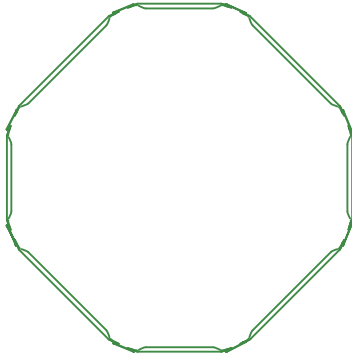

3

Utilisez F1, F3, A et Q pour relier les pièces d'assemblage (\*) de la première étape afin de former un hexagone.

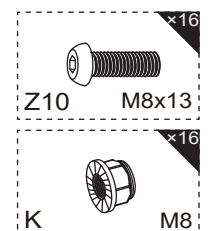
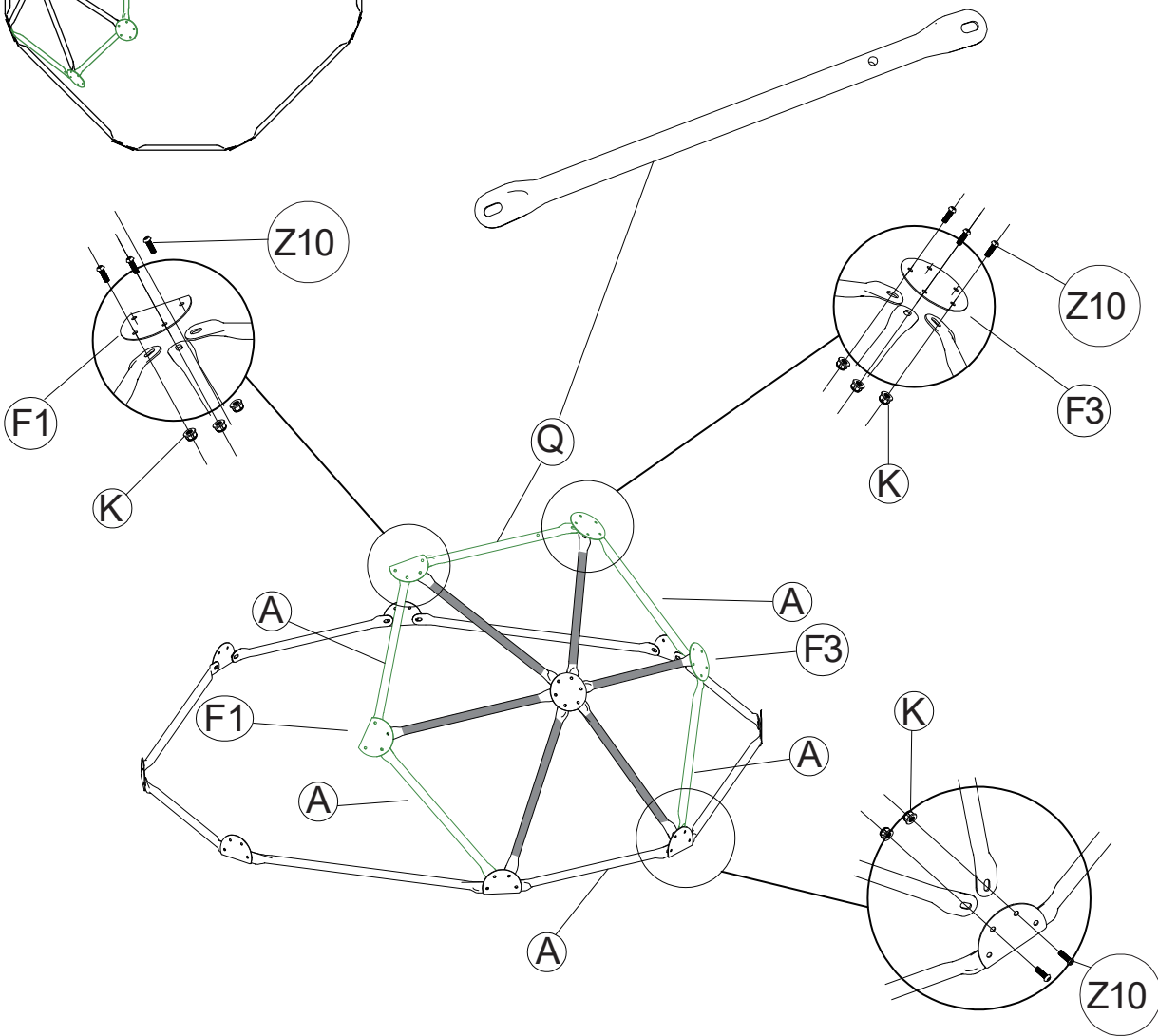
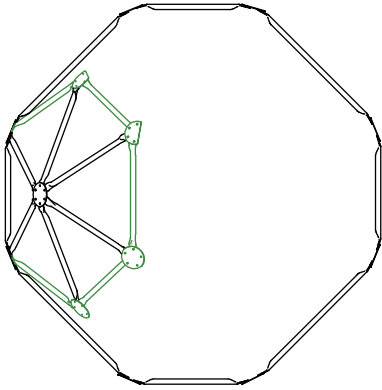

4

Utilisez A et F3 pour relier les pièces d'assemblage (\*) de la première étape afin de former la structure montrée sur l'image.

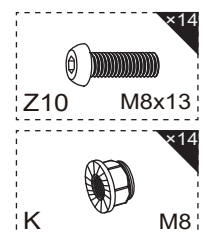
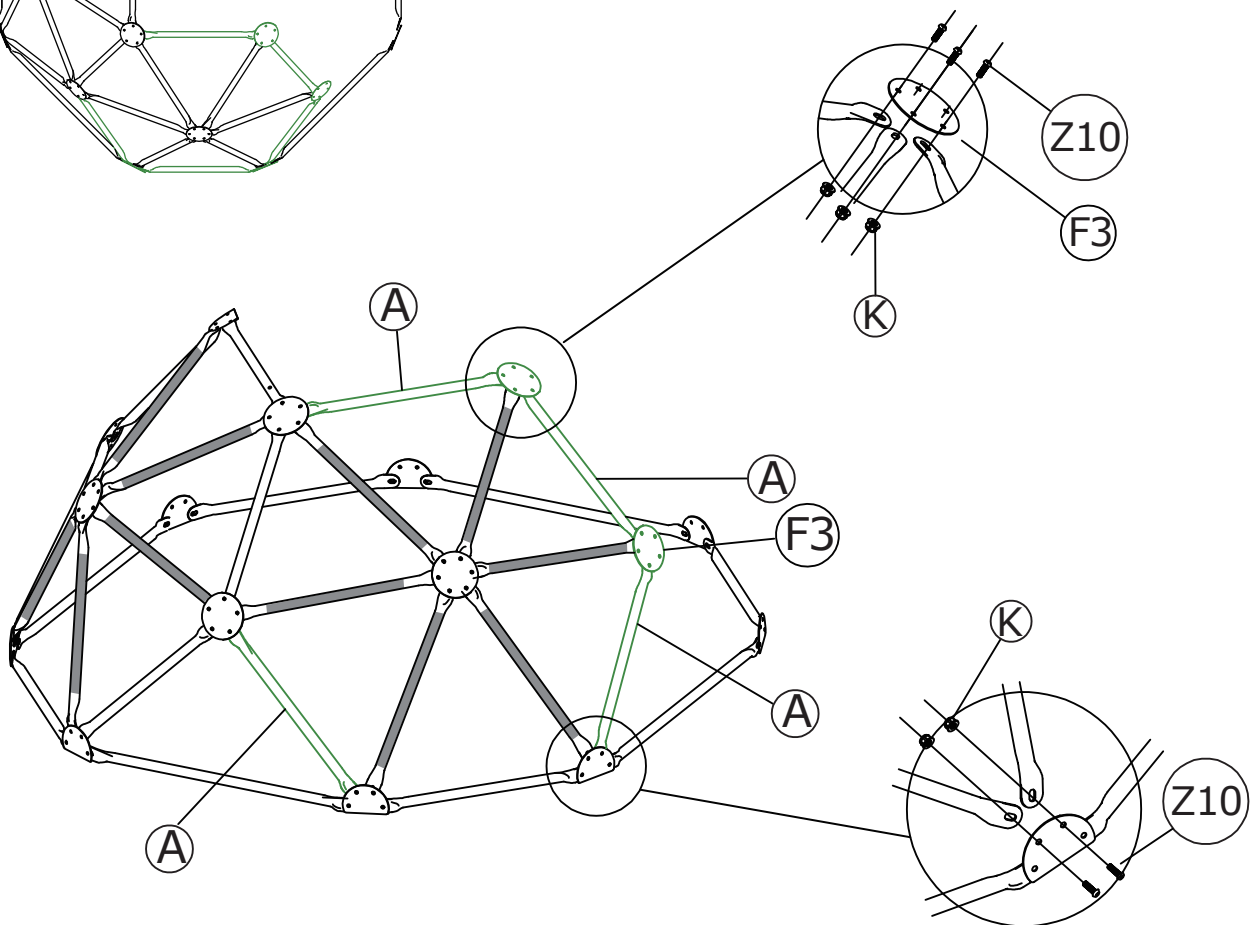
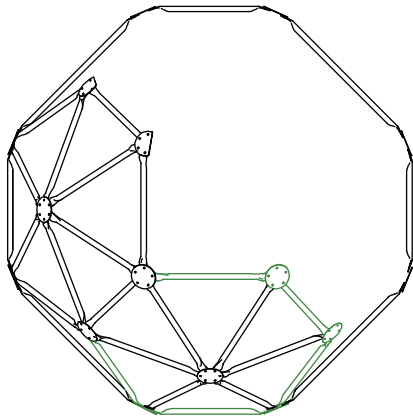

5

Utilisez F1, A et Q pour relier les pièces d'assemblage (\*) de la première étape. Faites attention à la direction lors de l'installation de Q. Le trou central est situé près du côté gauche de l'image.

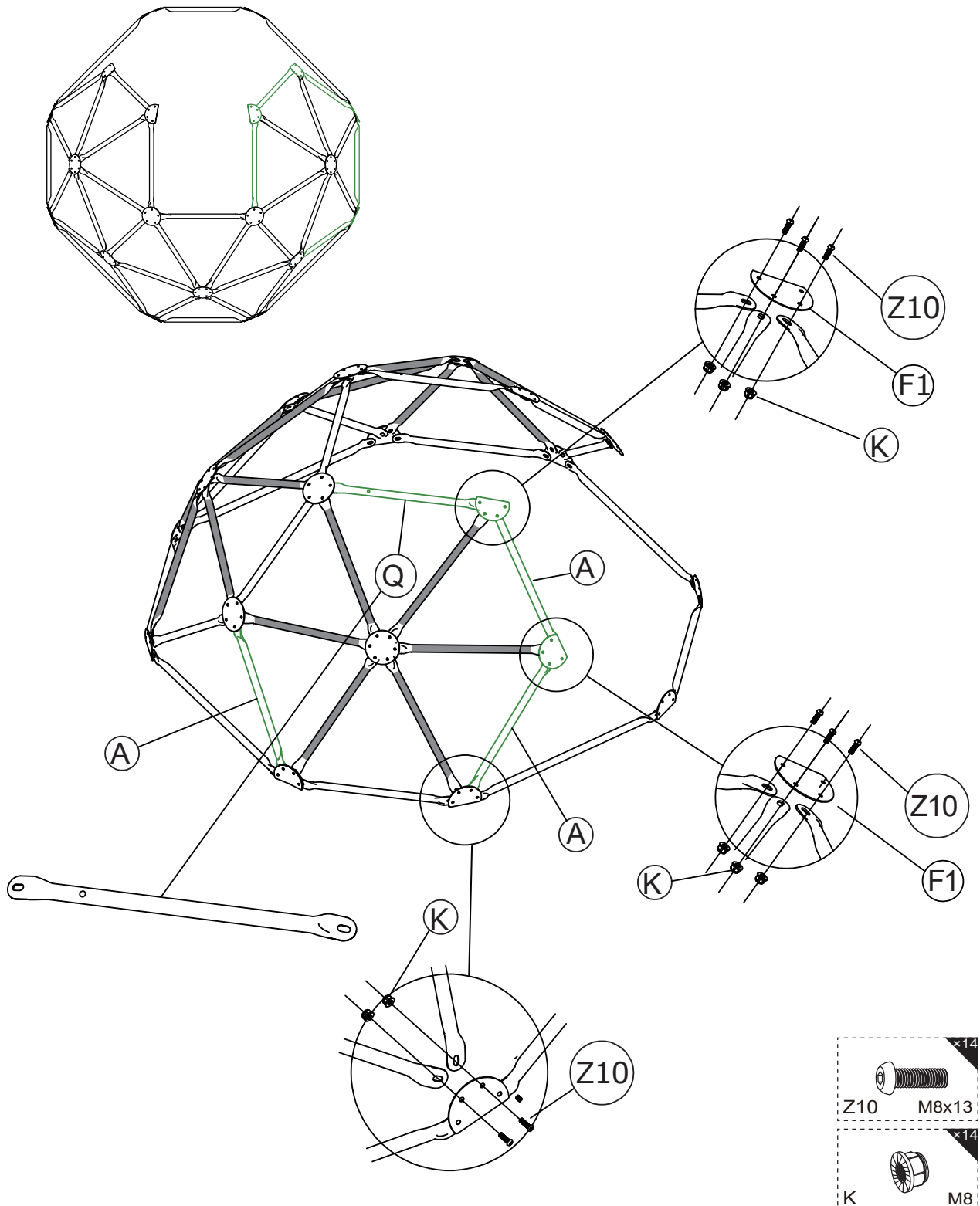

6

Lors de la connexion de A, E, H, G et H, tous les trous doivent être orientés vers le haut, et le côté court du trou central de E est proche du côté supérieur.

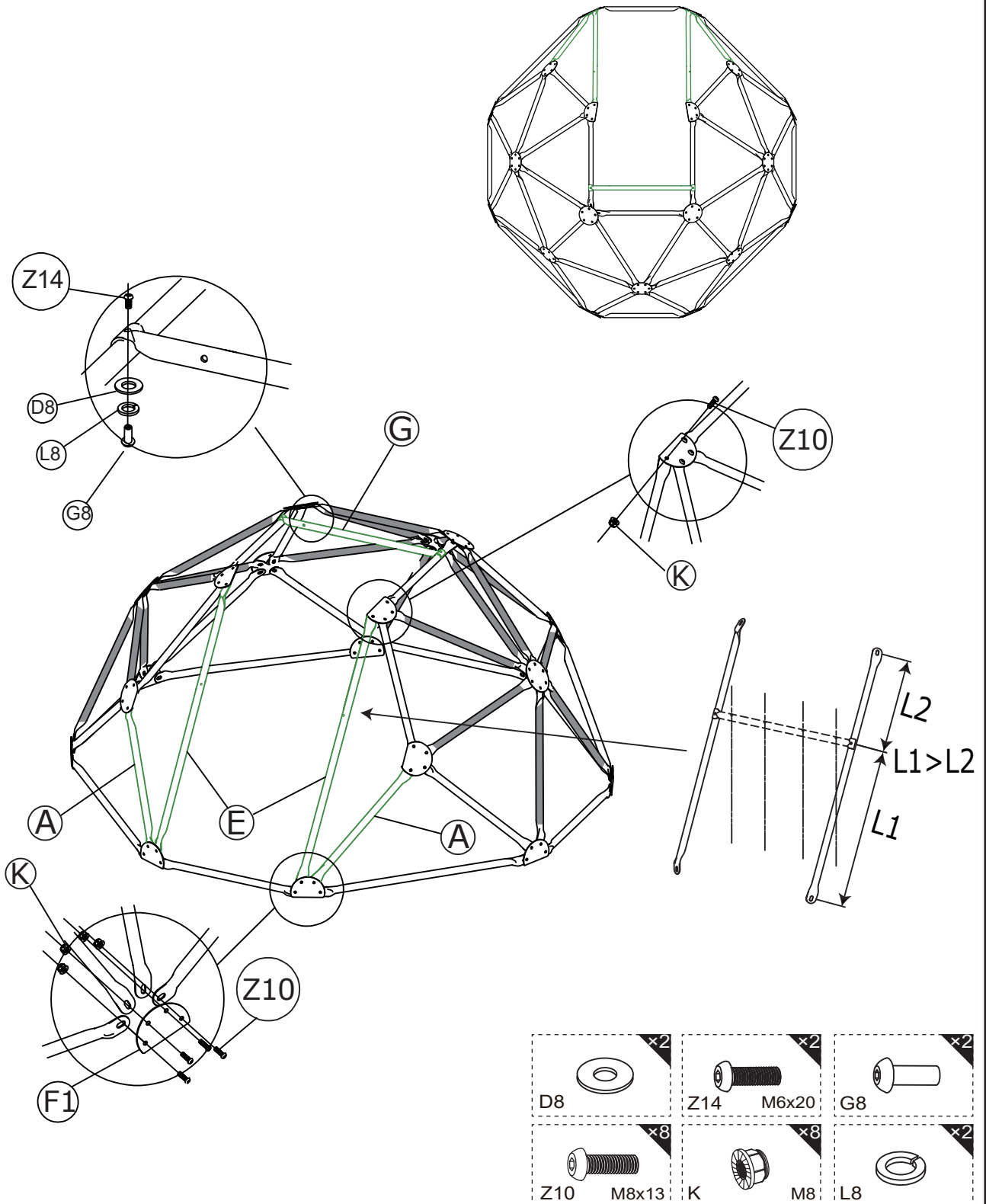

D,H et F doivent être passés à travers le tissu, puis vissés respectivement sur G et H.

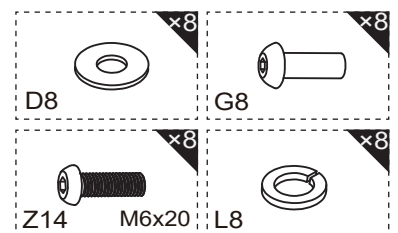
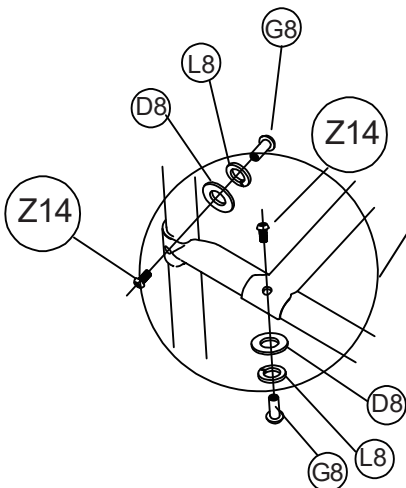
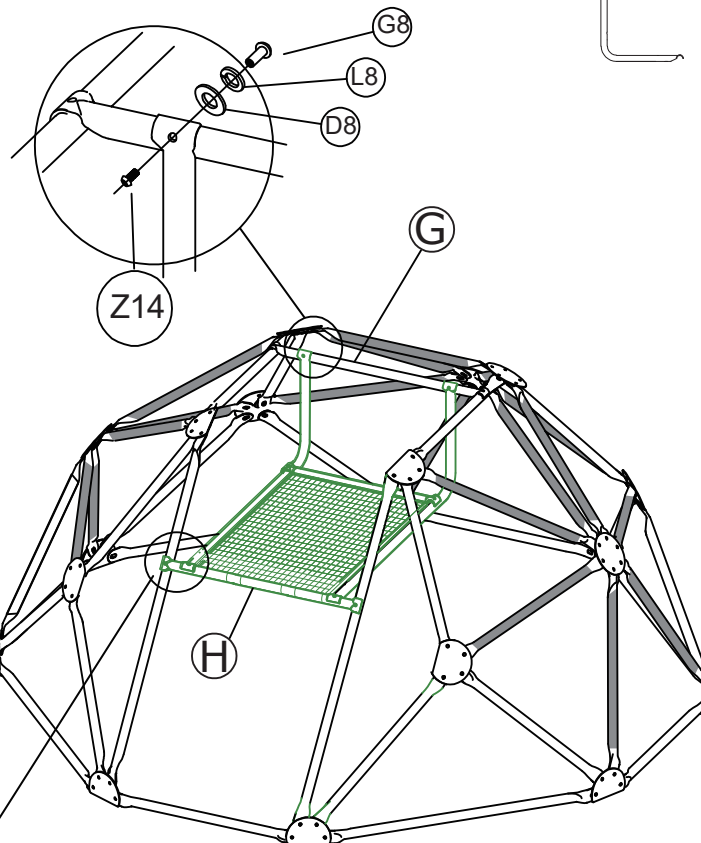
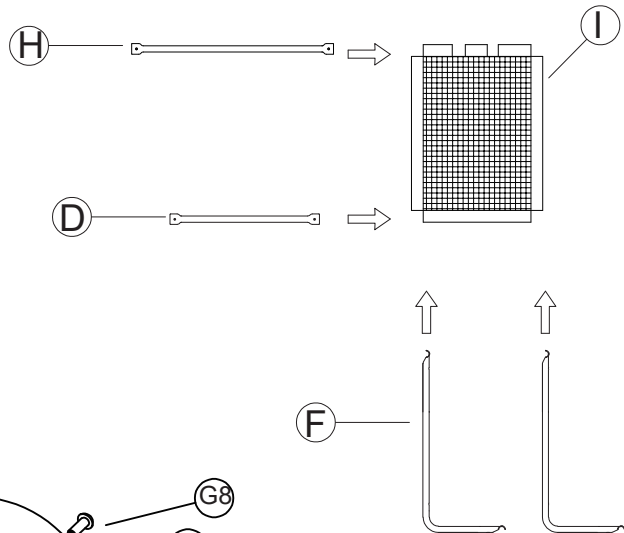
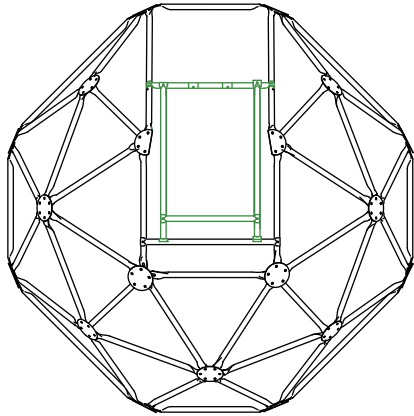

Installez le curseur sur H et serrez les vis.

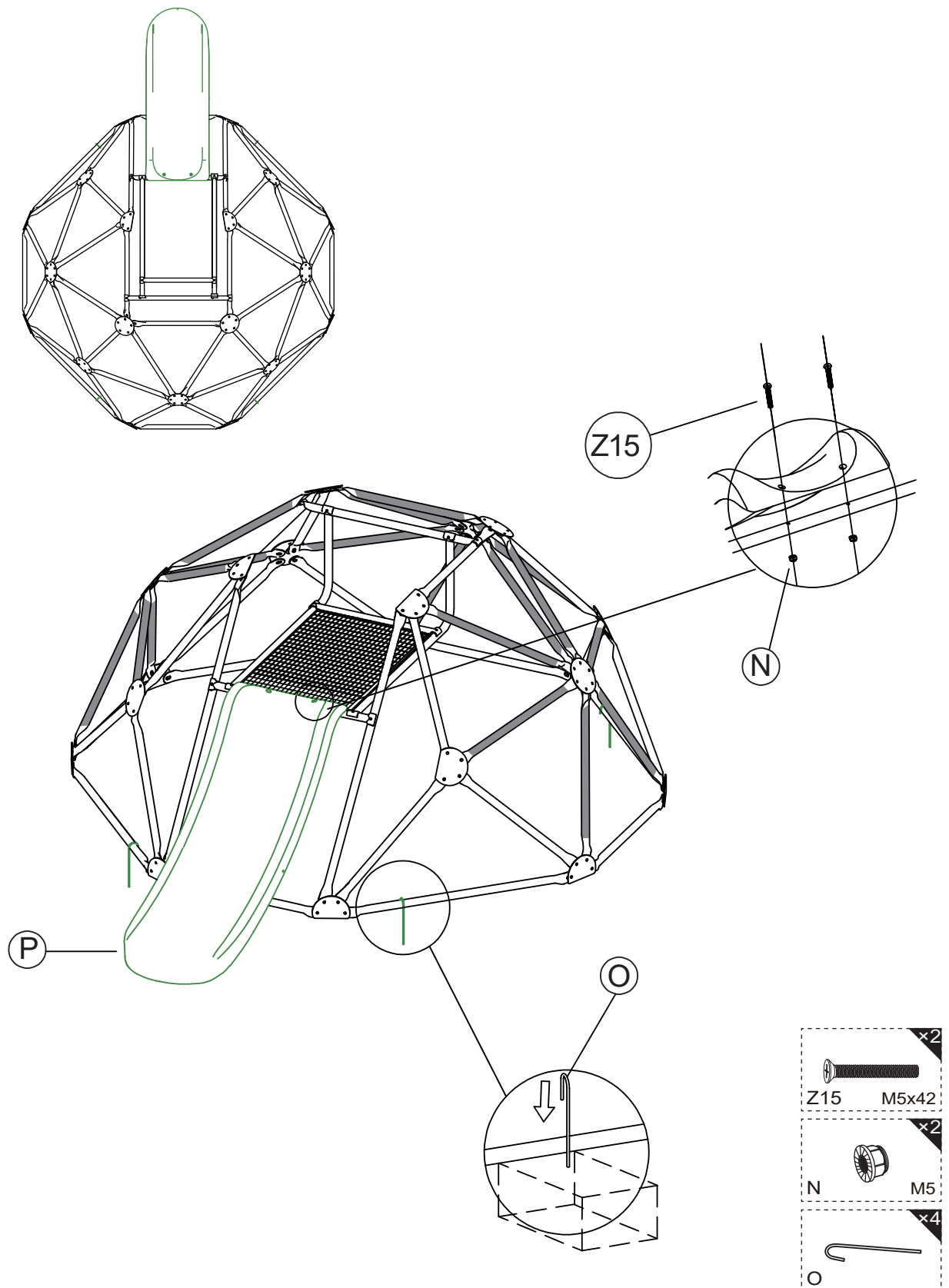

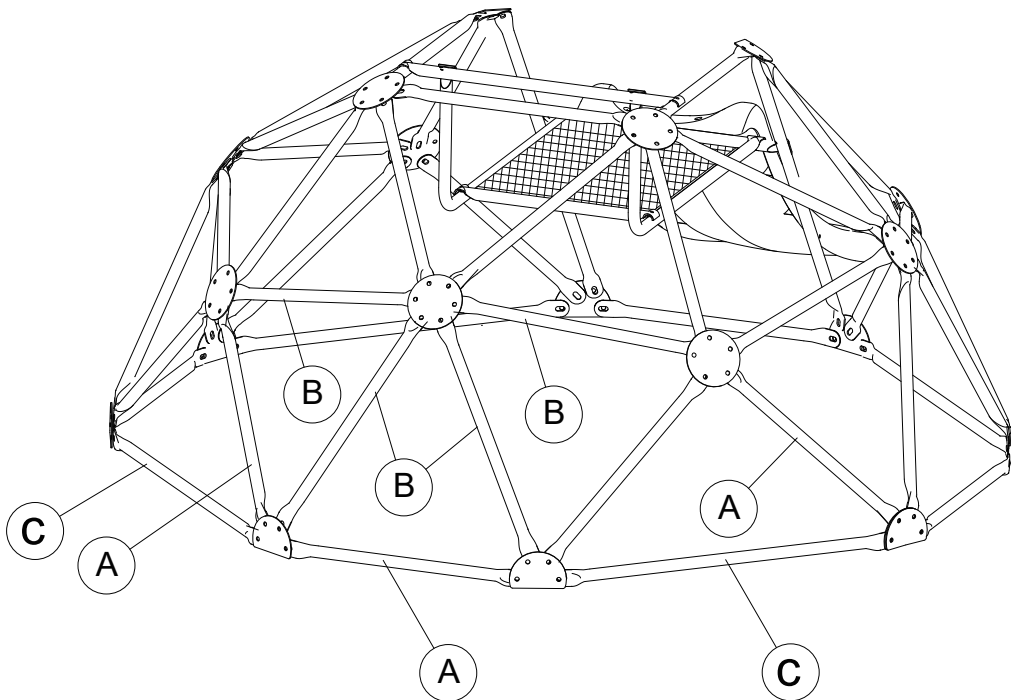
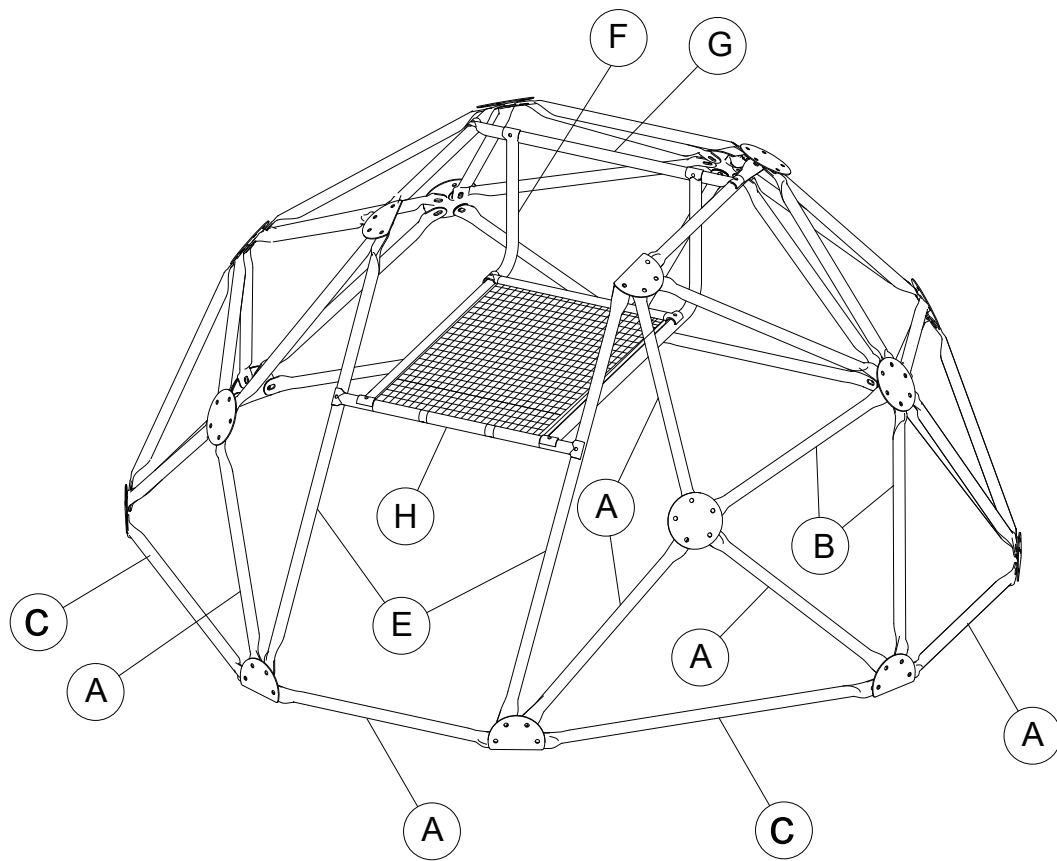

**Remarque :** Serrez toutes les vis une fois l'assemblage terminé.

## **INSTRUCTIONS DE MONTAGE**

Conservez les instructions pour référence future.

**AVERTISSEMENT:** Uniquement pour un usage résidentiel à l'extérieur et à l'intérieur.

**Cher client,**

Pour garantir la sécurité, veuillez prêter une attention particulière aux instructions de montage, de sécurité et d'entretien détaillées dans ce document.

### **CONSEILS DE MONTAGE**

Veuillez suivre les instructions de montage exactement comme indiqué.

- 1) Ce produit doit être assemblé par un adulte.
- 2) Conservez une copie des instructions de montage pour référence future. Cela peut être particulièrement utile pour l'identification des pièces dans le cas où un service après-vente est requis.
- 3) Avant de commencer, vérifiez qu'aucune pièce ne manque. Si vous constatez qu'il manque une pièce, contactez notre service après-vente.
- 4) Jetez soigneusement l'emballage.
- 5) Ne laissez pas les enfants jouer avec l'emballage.
- 6) Il est conseillé de ne pas orienter le toboggan vers le soleil.

### **CONSEIL DE SÉCURITÉ**

- 1) Ce produit ne doit pas être utilisé par des enfants de moins de 36 mois. Il convient uniquement aux enfants entre 3 et 12 ans avec un poids maximum de 50 kg. Il doit être utilisé sous la surveillance d'un adulte. Trois enfants au maximum peuvent l'utiliser en même temps.
- 2) Étant donné que ce produit contient de petites pièces qui peuvent être avalées, gardez les pièces hors de portée des enfants de moins de 36 mois.
- 3) Ce produit est destiné à un usage domestique privé uniquement et ne doit jamais être utilisé dans les parcs et jardins publics, les écoles, les campings, les hôtels, les zones de loisirs publiques, etc.

- 4) Ce produit doit être installé sur une surface plane à 2 m de tout autre objet, structure ou obstacle (murs, clôtures, arbres, cordes à linge ou lignes électriques, etc.) pouvant causer des blessures lors de l'utilisation.
- 5) Ce produit ne doit pas être installé sur des surfaces dures telles que le béton, l'asphalte ou d'autres surfaces dures. Nous recommandons l'installation sur de l'herbe ou d'autres surfaces molles.
- 6) Ce produit doit être solidement ancré dans le sol. Veuillez suivre attentivement les instructions pour le faire. Utiliser ce produit uniquement lorsque le béton est sec.
- 7) Les ancres doivent être placées au niveau du sol ou sous le niveau du sol afin de réduire les risques de trébuchement.
- 8) L'ancrage doit être vérifié régulièrement, en plus des crochets et des fixations.
- 9) Jetez soigneusement l'emballage.
- 10) Ne laissez pas les enfants jouer avec l'emballage.
- 11) Pendant le montage, éloignez les enfants du produit pour éviter que les petits accessoires ne soient avalés.

## **MAINTENANCE**

- 1) Toutes les pièces métalliques sont en acier galvanisé et revêtues de poudre pour les protéger contre la rouille. Cependant, dans certaines zones proches de la mer, nous vous conseillons de prévoir un traitement antirouille supplémentaire.
- 2) Les surfaces de toutes les pièces doivent être vérifiées au moins une fois par mois, en particulier les fixations telles que les crochets de poutre supérieure. Si les fixations et les crochets présentent une usure supérieure à 10 % de leur épaisseur d'origine, ils doivent être remplacés par les mêmes fixations que celles fournies à l'origine.
- 3) Vérifiez le serrage de tous les écrous et boulons et serrez si nécessaire.
- 4) Vérifiez tous les revêtements pour les boulons et les bords tranchants et remplacez-les si nécessaire.

- 5) Les jouets peuvent s'effondrer ou être dangereux s'ils ne sont pas vérifiés régulièrement.
- 6) Le sol sur lequel le produit est placé doit être contrôlé régulièrement. Les éléments tels que les pierres ou autres objets susceptibles de causer des blessures en cas de chute doivent être enlevés. Il est conseillé de retirer l'appareil pendant la période hivernale ou lorsqu'il n'est pas utilisé, afin d'éviter toute détérioration due aux intempéries.
- 7) Tout matériel et/ou pièces usagés doivent être remplacés par une pièce fournie par notre service après-vente.
- 8) Toute modification apportée par le consommateur au jouet d'activité d'origine doit être effectuée conformément aux instructions du fabricant.
- 9) Poncer les zones rouillées et les éléments tubulaires et repeindre avec une peinture sans plomb si nécessaire.

### CONSEILS PRATIQUES

Des contrôles de sécurité pour ce produit doivent être effectués régulièrement. Ces vérifications doivent inclure, si nécessaire, l'élimination des arêtes vives, le remplacement des capuchons de boulons manquants et le serrage des écrous et des boulons. Ces contrôles doivent être effectués pour éviter tout danger ou renversement dû à l'usure normale.

### IMPORTANT!

Attendez que le béton soit pris avant d'utiliser votre toboggan et vérifiez régulièrement les ancrages. Les enfants ne doivent pas sauter violemment sur le toboggan.

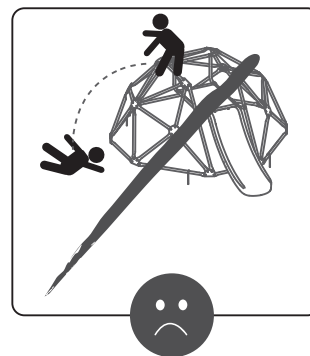
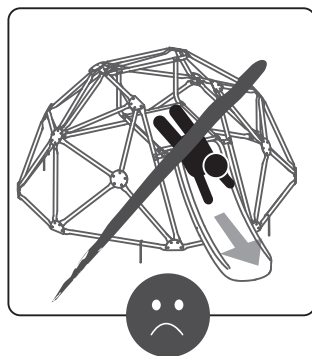
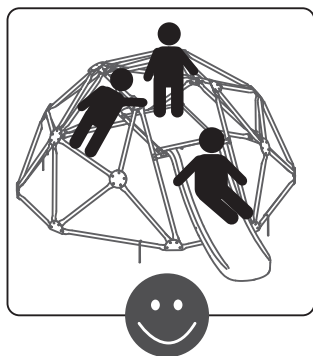

Personne de contact  
Made4Home SAS  
137 av. Gustave Eiffel  
ZI Rognac Nord  
13340 Rognac (France)  
téléphone au: +33 4 42 81 81 80  
www.tectake.fr  
E-Mail: [contact@tectake.fr](mailto:contact@tectake.fr)

# Cúpula de Escalada para Niños con Tobogán

## SEGÚN LOS REQUISITOS DE SEGURIDAD

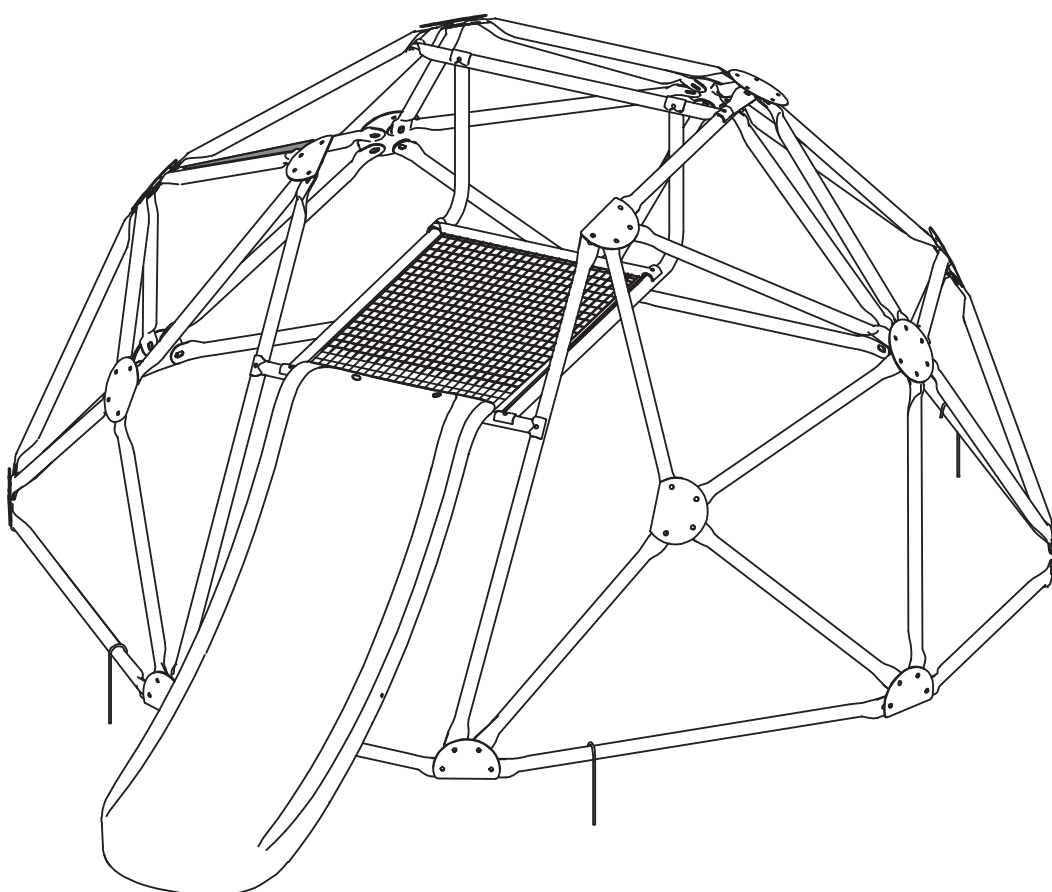





**MANUAL DE INSTRUCCIONES ORIGINAL  
CONSERVELO PARA FUTURAS CONSULTAS**





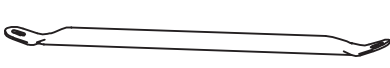

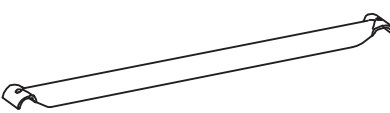

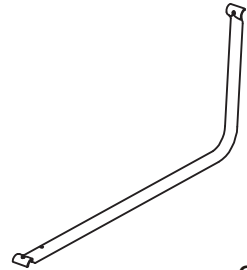

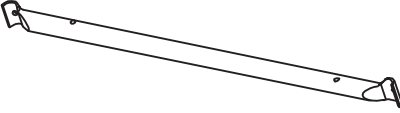
ES

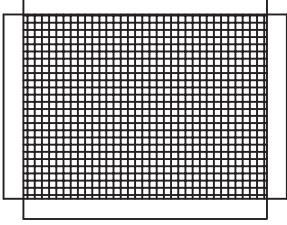
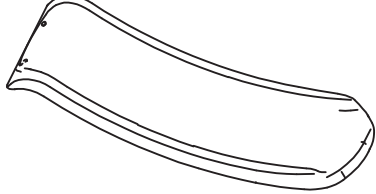
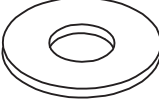
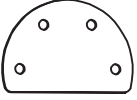
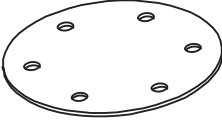
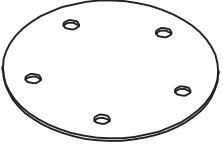
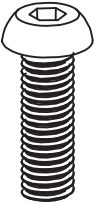
- ⚠ ¡Peligro! Mantenga todas las piezas pequeñas y los materiales de embalaje de este producto fuera del alcance de los bebés y los niños, ya que de lo contrario pueden suponer un peligro de asfixia.
- ⚠ El producto debe instalarse y usarse bajo la supervisión de un adulto.
- ⚠ Lea cada paso cuidadosamente y siga el orden correcto.
- ⚠ Retire todo el embalaje, separe y cuente todas las piezas y los accesorios antes de la instalación.
- ⚠ Asegúrese de que todas las piezas estén instaladas correctamente, una instalación incorrecta puede provocar un peligro.
- ⚠ Recomendamos que, siempre que sea posible, todos los elementos se monten cerca de la zona en la que se van a utilizar, para evitar mover el producto innecesariamente una vez montado.
- ⚠ Asegure una superficie segura durante el montaje, y coloque el producto siempre sobre una superficie plana, firme y estable.

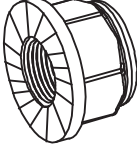
## LISTA DE PIEZAS

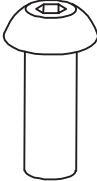
**Nota:** Algunas de estas piezas tienen repuestos adicionales.

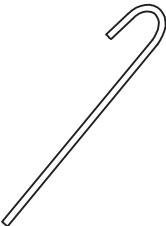
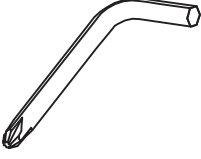
<p><b>A</b></p>  <p>azul 17pcs</p>	<p><b>B</b></p>  <p>rojo 18pcs</p>	<p><b>C</b></p>  <p>azul 4pcs</p>
<p><b>D</b></p>  <p>azul 1pc</p>	<p><b>E</b></p>  <p>azul 2pcs</p>	<p><b>F</b></p>  <p>azul 2pcs</p>

<p><b>G</b></p>  <p>azul 1pc</p>	<p><b>H</b></p>  <p>azul 1pc</p>	<p><b>Q</b></p>  <p>azul 2pcs</p>	
<p><b>I</b></p>  <p>1pc</p>	<p><b>P</b></p>  <p>1pc</p>	<p><b>D8</b></p>  <p>10pcs</p>	
<p><b>F1</b></p>  <p>12pcs</p>	<p><b>F2</b></p>  <p>3pcs</p>	<p><b>F3</b></p>  <p>4pcs</p>	
<p><b>Z10</b></p>  <p>M8x13 86pcs</p>	<p><b>Z14</b></p>  <p>M6x20 10pcs</p>	<p><b>Z15</b></p>  <p>M5x42 2pcs</p>	
<p><b>K</b></p>  <p>M8 86pcs</p>	<p><b>N</b></p>  <p>M5 2pcs</p>	<p><b>G8</b></p>  <p>10pcs</p>	
<p><b>L8</b></p>  <p>10pcs</p>	<p><b>O</b></p>  <p>4pcs</p>	<p><b>A5</b></p>  <p>2pcs</p>	<p><b>K1013</b></p>  <p>1pc</p>

# MONTAJE

1

Ensamble primero las 3 piezas en forma de (\*) que se muestran en la figura para utilizarlas en los siguientes pasos de la instalación. Las líneas verdes representan las piezas necesarias para la instalación actual.

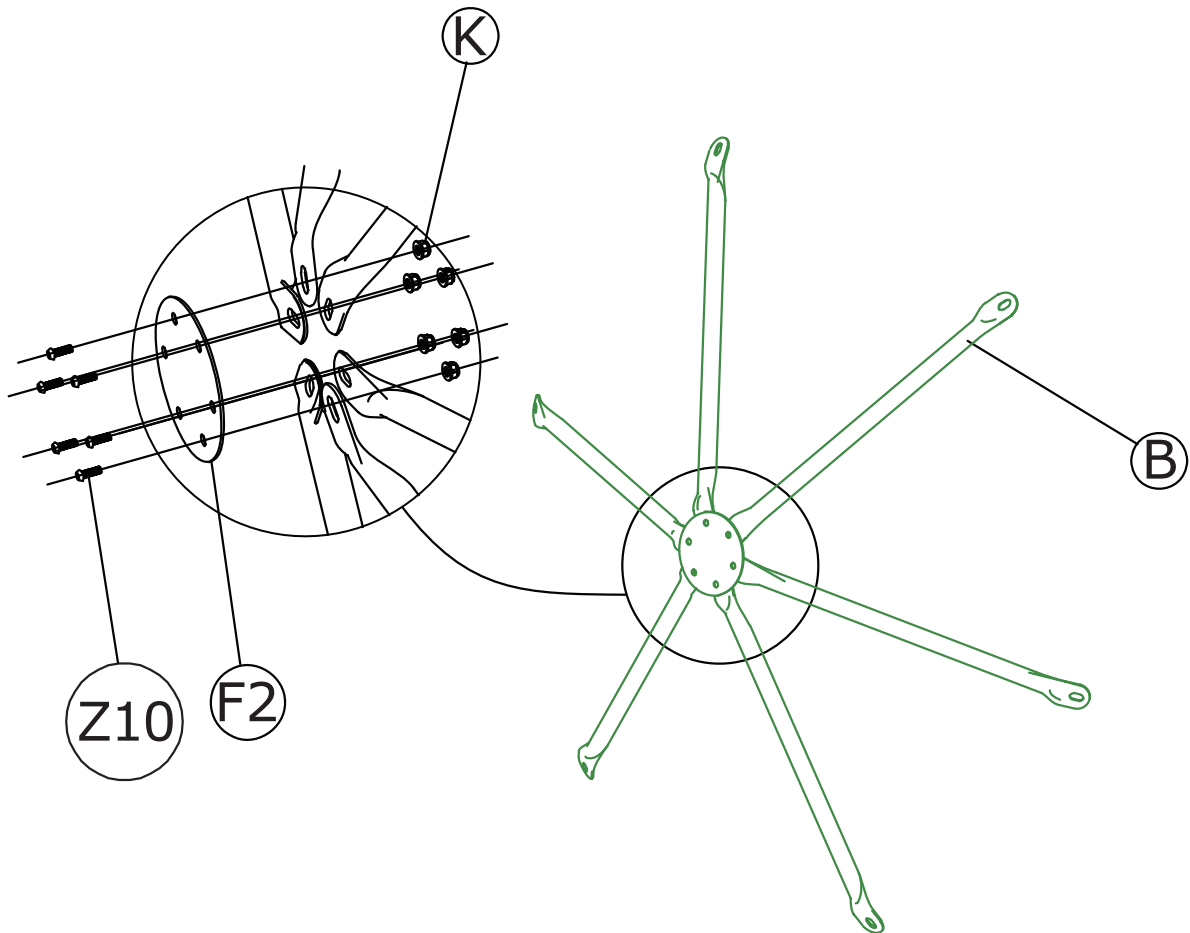

×3

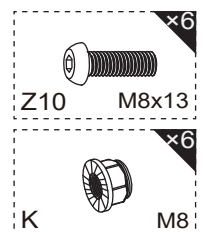

Utilice F1 para conectar alternativamente A y C para formar un octógono.

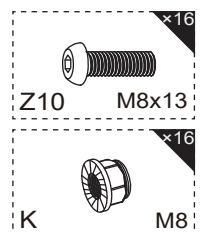
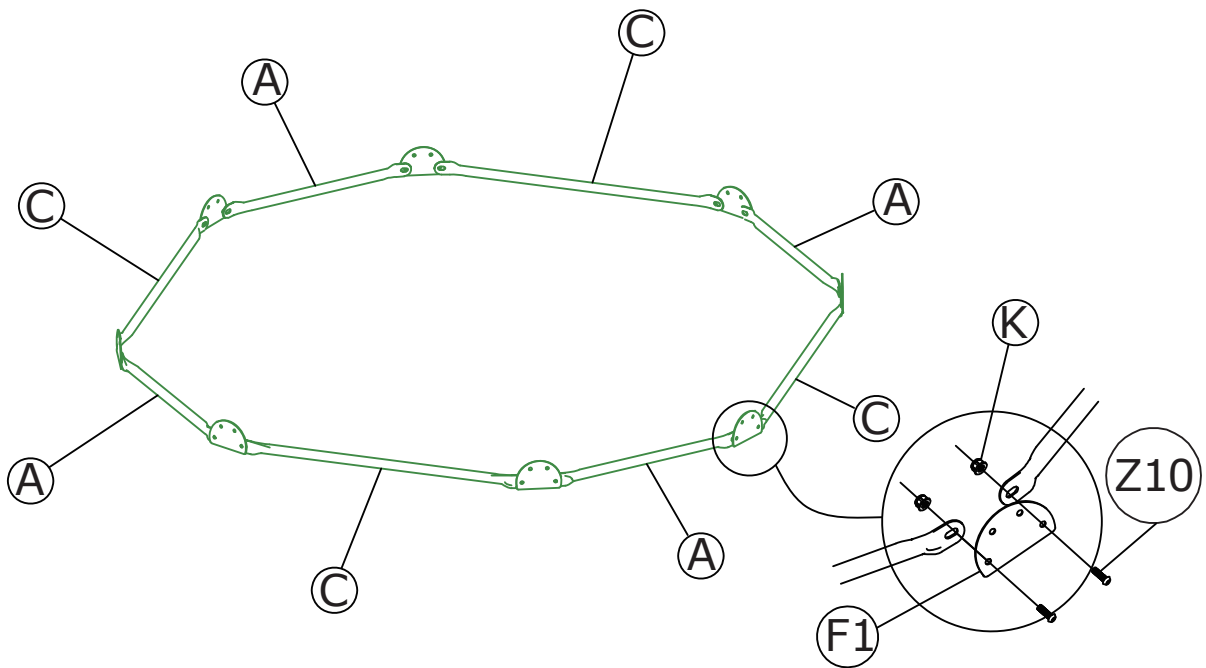
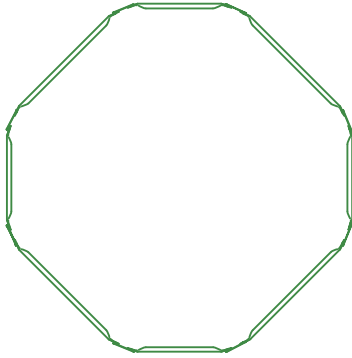

3

Utilice F1, F3, A y Q para conectar las piezas de montaje (\*) en el primer paso para formar un hexágono.

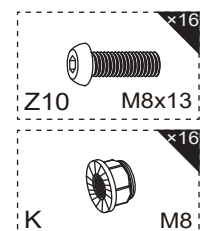
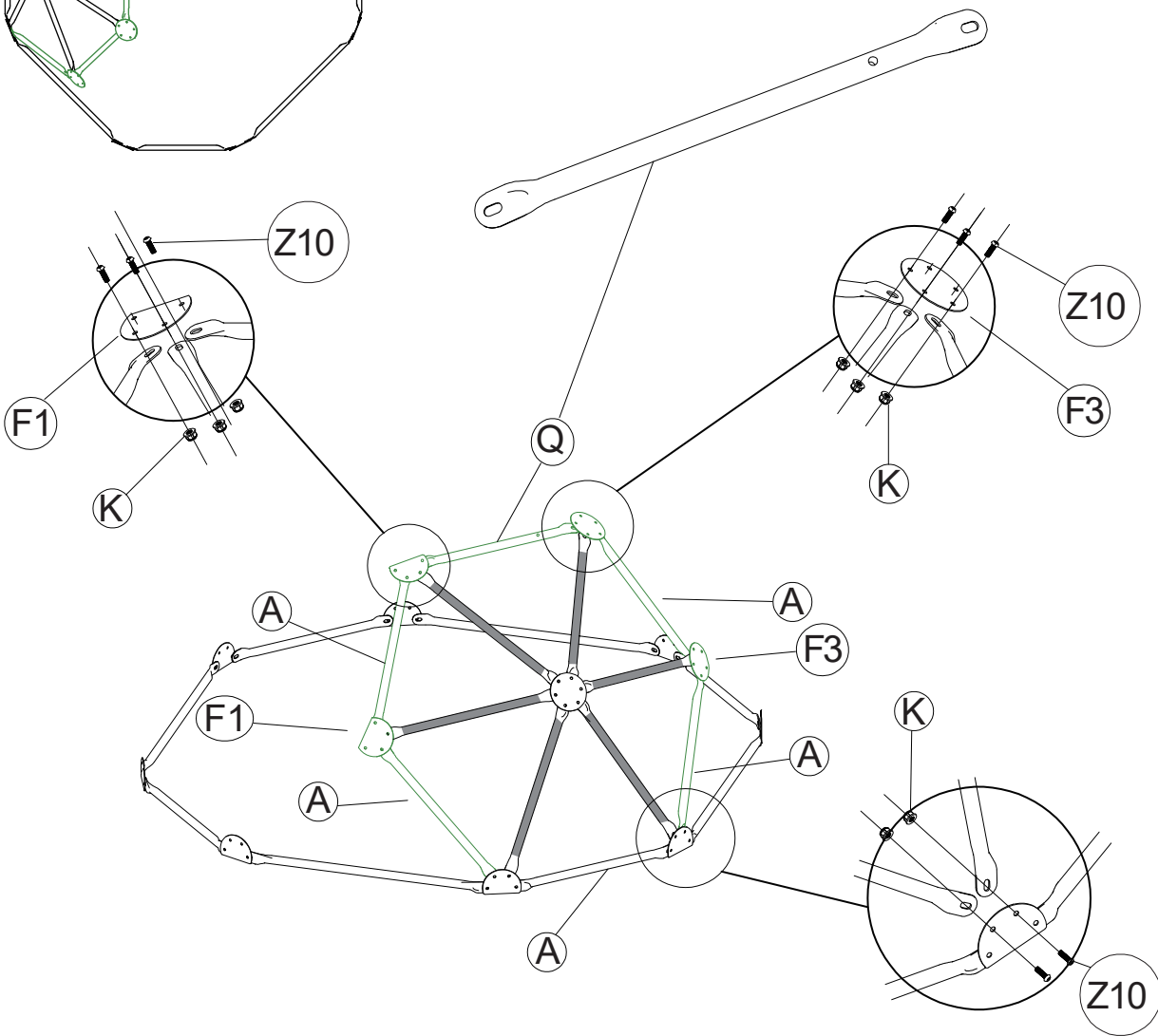
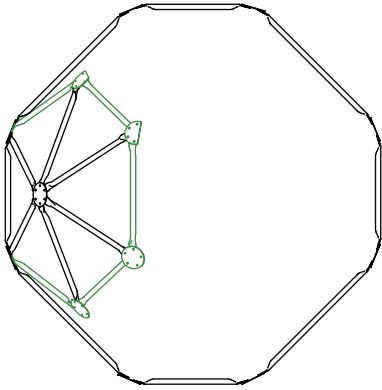

4

Utilice A y F3 para conectar las piezas de montaje (\*) del primer paso y formar la estructura que se muestra en la imagen.

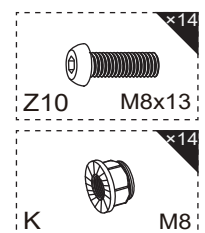
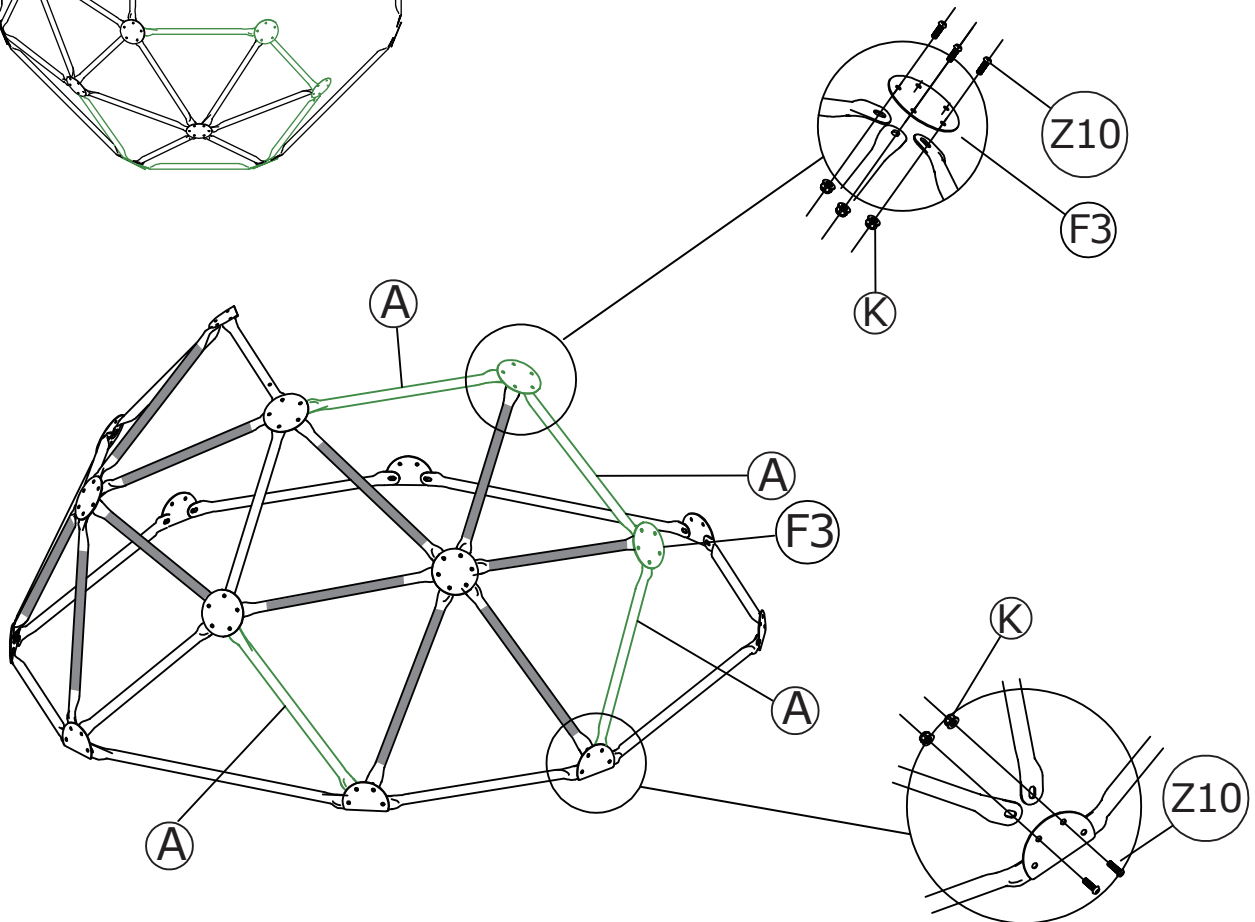
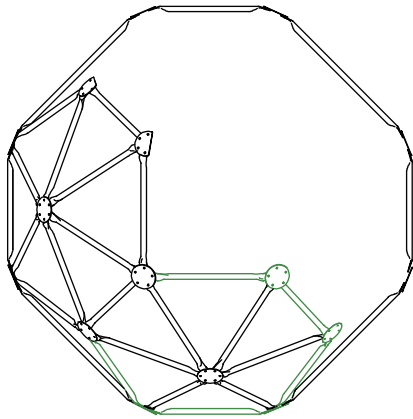

5

Utilice F1, A y Q para conectar las piezas de montaje (\*) en el primer paso. Preste atención a la dirección cuando instale Q. El orificio central está situado cerca del lado izquierdo de la imagen.

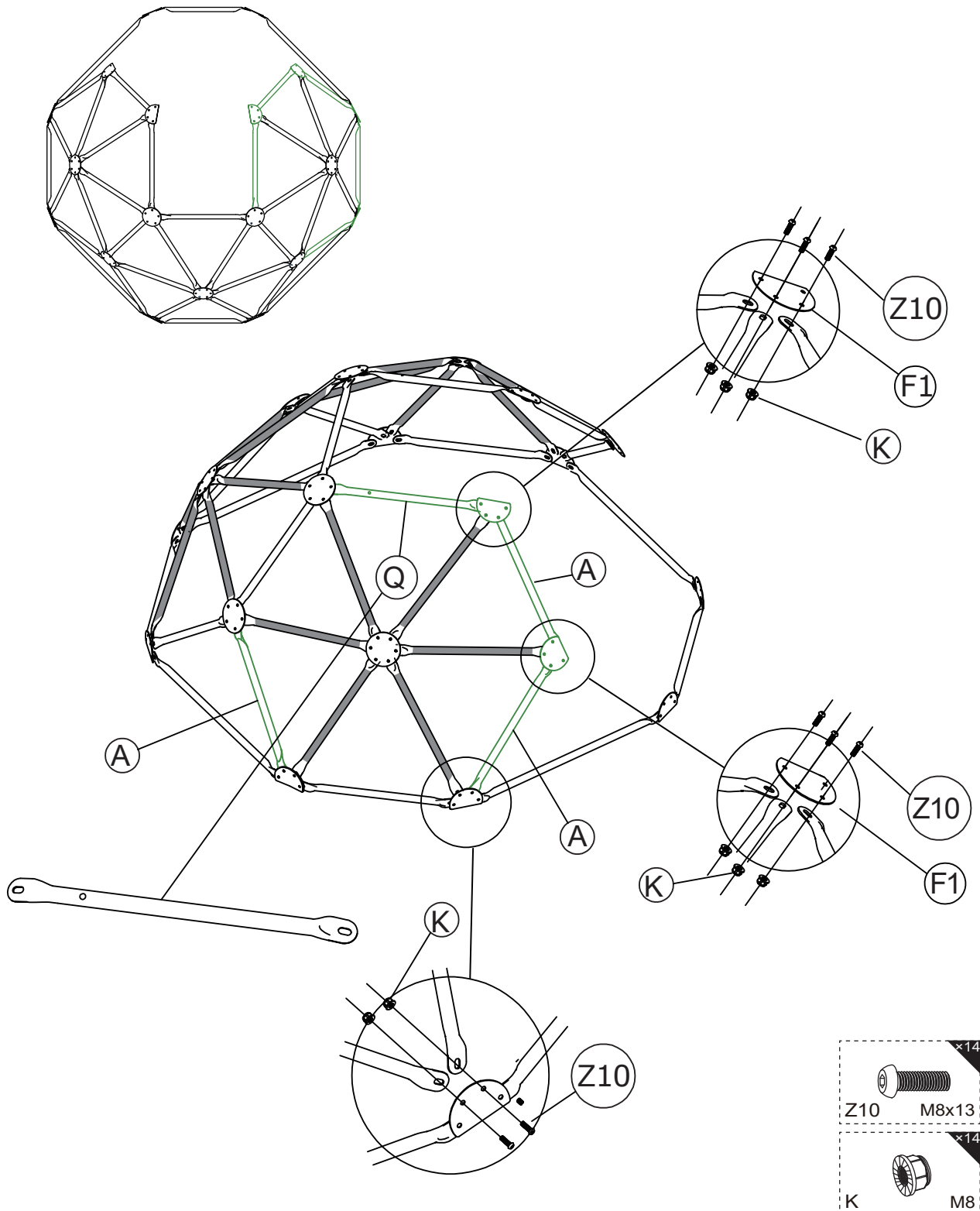

6

Al conectar A, E, H, G y H, todos los orificios deben mirar hacia arriba, y el lado corto del orificio central de E debe estar cerca del lado superior.

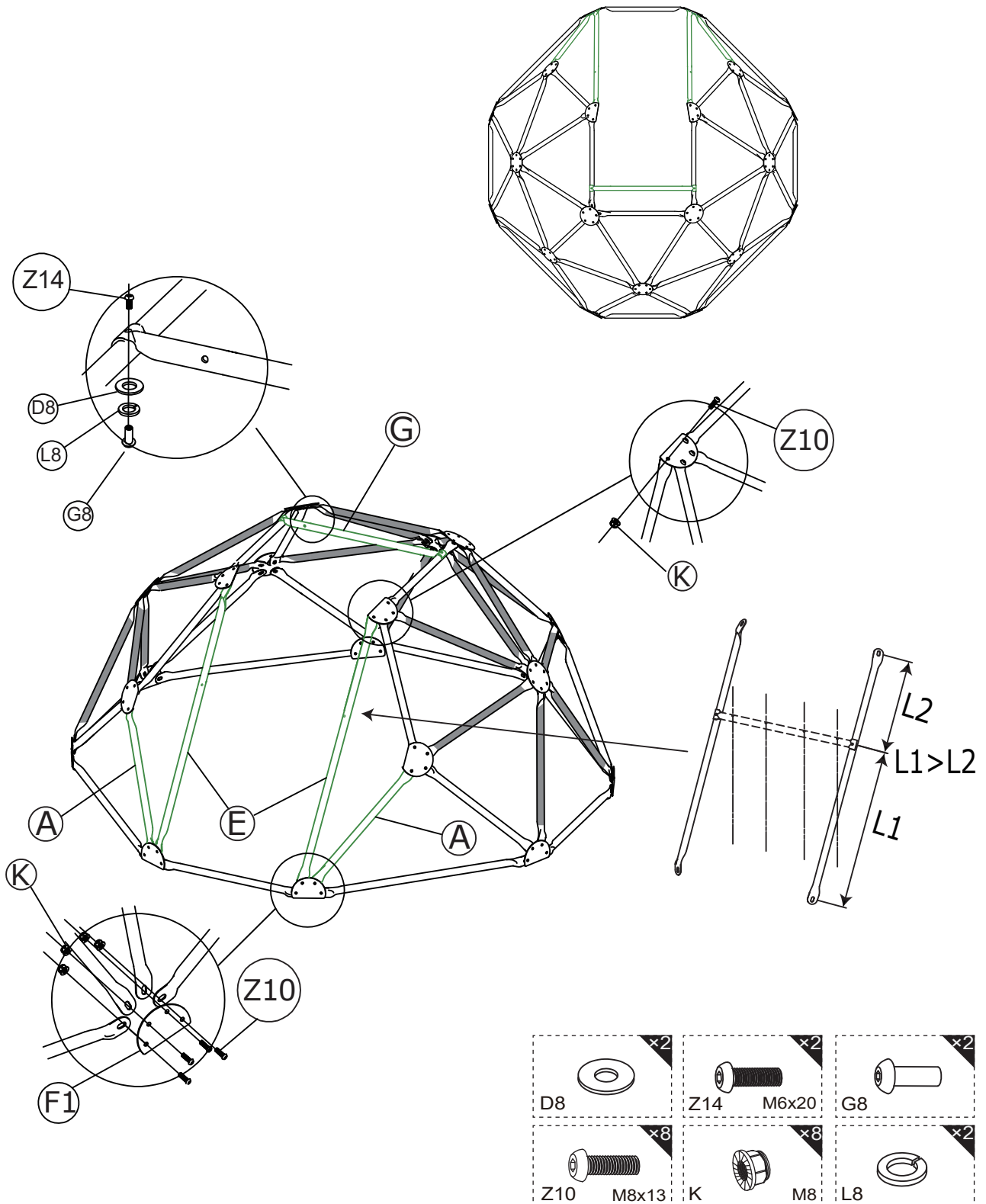

D,H y F deben pasarse a través de la tela y luego atornillarse a G y H respectivamente.

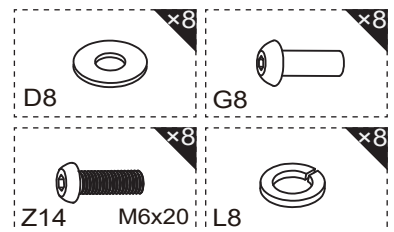
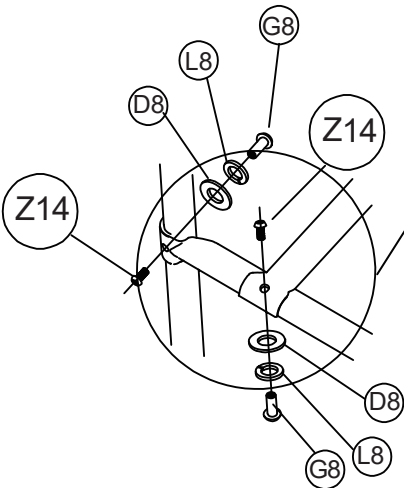
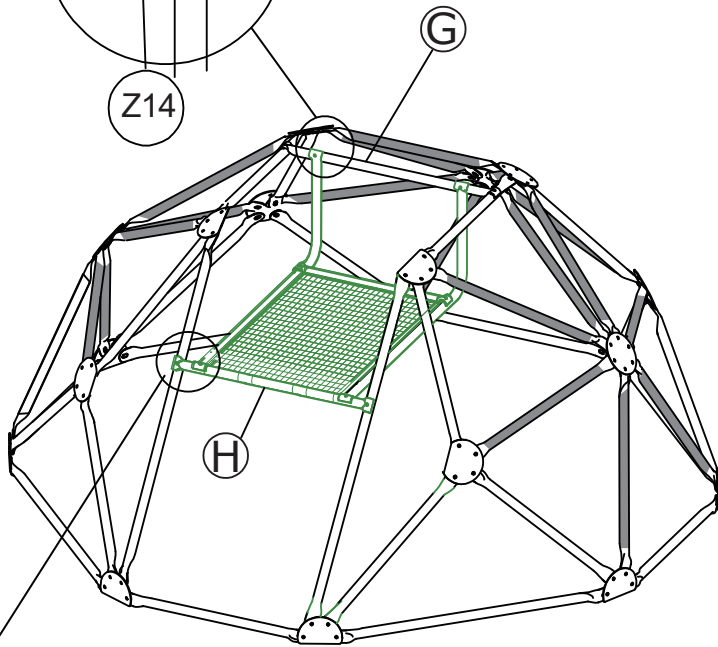
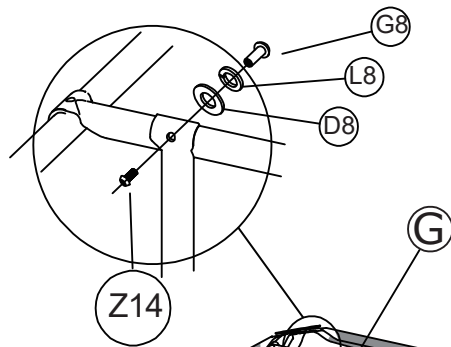
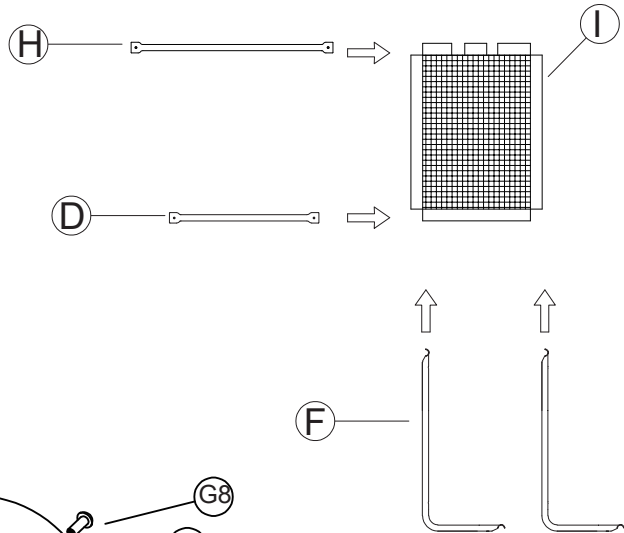
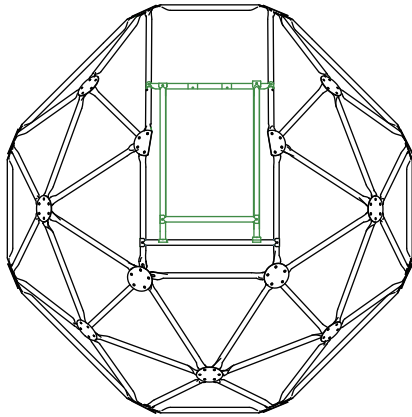

Instale el tobogán en H y apriete los tornillos.

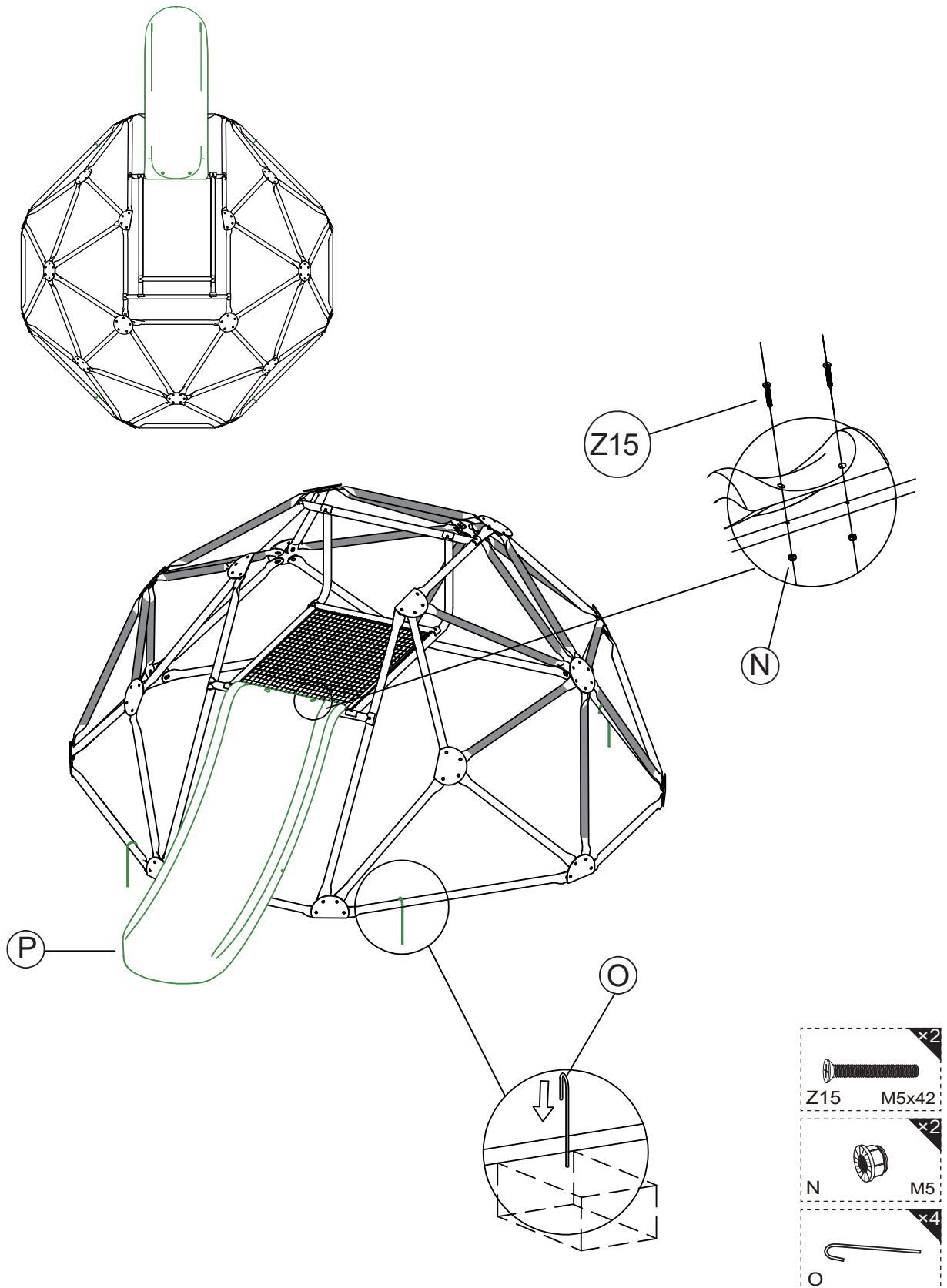

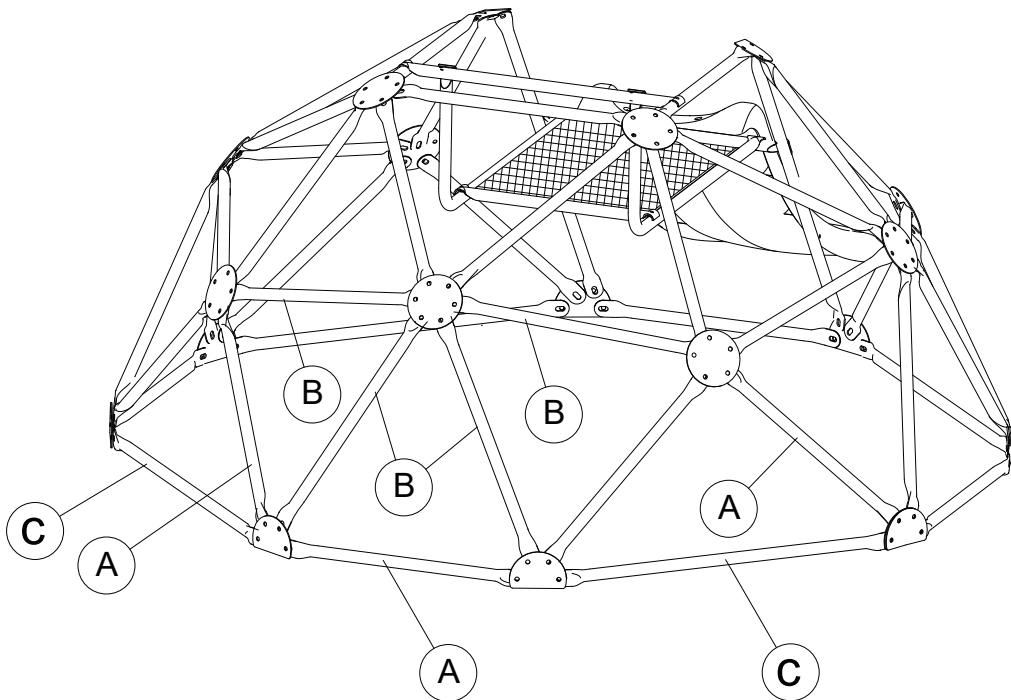
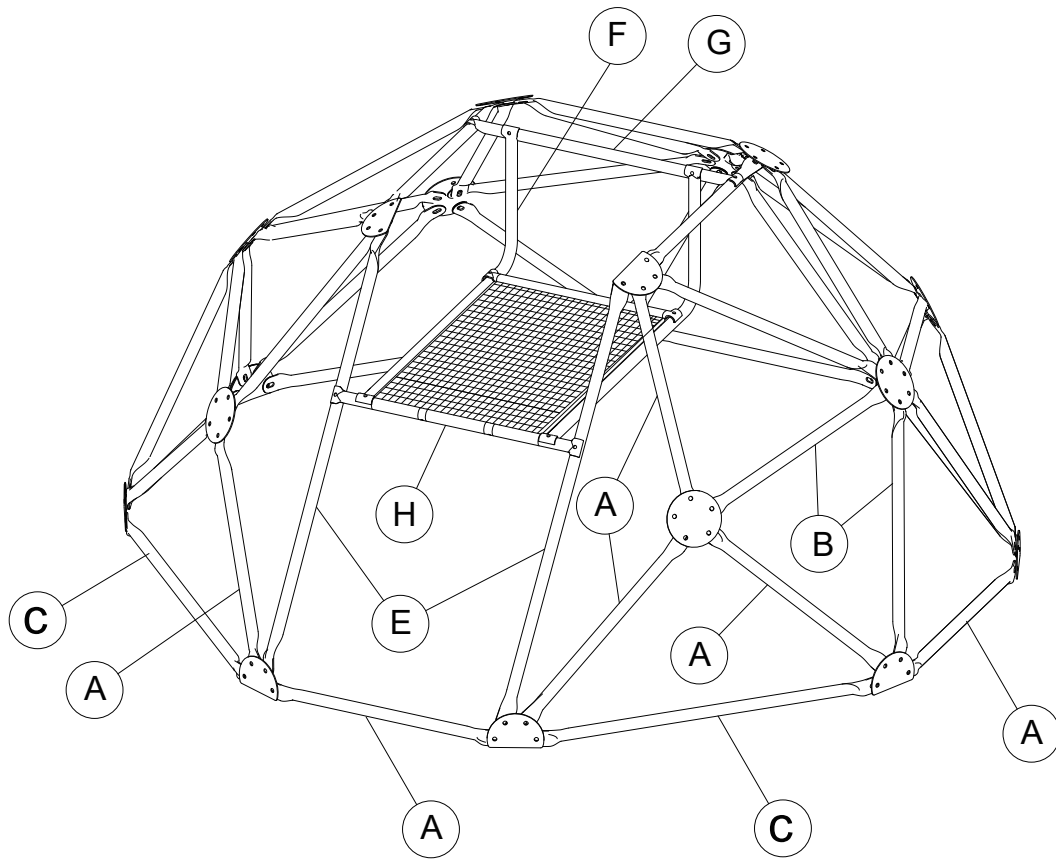

**Nota:** Apriete todos los tornillos después de completar todo el montaje.

## **INSTRUCCIONES DE MONTAJE**

Conserve las instrucciones para futuras consultas.

**ADVERTENCIA:** Sólo para uso residencial en exteriores e interiores.

**Estimado cliente,**

Para garantizar la seguridad, le rogamos que preste especial atención a las instrucciones de montaje, seguridad y cuidado detalladas en este documento.

### **CONSEJOS DE MONTAJE**

Por favor, siga las instrucciones de montaje exactamente como se indican.

- 1) Este producto debe ser montado por un adulto.
- 2) Conserve una copia de las instrucciones de montaje para futuras consultas. Esto puede ser especialmente útil para la identificación de las piezas en caso de que se requiera un servicio postventa.
- 3) Antes de comenzar, compruebe que no falta ninguna pieza. Si comprueba que le falta alguna pieza, póngase en contacto con nuestro servicio postventa.
- 4) Deseche el embalaje con cuidado.
- 5) No permita que los niños jueguen con el embalaje.
- 6) Aconsejamos que el tobogán no esté orientado hacia el sol.

### **CONSEJOS DE SEGURIDAD**

- 1) Este producto no debe ser utilizado por niños menores de 36 meses. Solo es adecuado para niños de entre 3 y 12 años con un peso máximo de 50 kg. Debe utilizarse bajo la supervisión de un adulto. Pueden utilizarlo un máximo de 3 niños al mismo tiempo.
- 2) Dado que este producto contiene piezas pequeñas que pueden ser ingeridas, mantenga las piezas fuera del alcance de los niños menores de 36 meses.
- 3) Este producto es solo para uso privado en el hogar y nunca debe ser utilizado en parques y jardines públicos, en escuelas, campings, hoteles, zonas de ocio públicas, etc.

- 4) Este producto debe instalarse en una superficie plana a 2 m de distancia de cualquier otro objeto, estructura u obstáculo (paredes, vallas, árboles, tendedores o cables eléctricos, etc.) que pueda causar lesiones durante su uso.
- 5) Este producto no debe instalarse sobre superficies duras como hormigón, asfalto u otras superficies duras. Recomendamos la instalación sobre césped u otras superficies blandas de este tipo.
- 6) Este producto debe empotrarse firmemente en el suelo. Por favor, siga cuidadosamente las instrucciones para hacerlo. Utilice este producto solo cuando el hormigón esté seco.
- 7) Los anclajes deben colocarse a nivel o por debajo del nivel del suelo para reducir el riesgo de tropiezos.
- 8) El anclaje debe ser revisado regularmente, además de los ganchos y las fijaciones.
- 9) Deseche los embalajes con cuidado.
- 10) No permita que los niños jueguen con los embalajes.
- 11) Durante el montaje, mantenga a los niños alejados del producto para evitar que se traguen los pequeños accesorios.

## **MANTENIMIENTO**

- 1) Todas las piezas metálicas son de acero galvanizado y están recubiertas de polvo para protegerlas de la oxidación. Sin embargo, en ciertas zonas cercanas al mar, aconsejamos que sea necesario un tratamiento adicional para evitar la oxidación.
- 2) Las superficies de todas las piezas deben ser revisadas al menos una vez al mes, especialmente las fijaciones como los ganchos de la viga superior. Si las fijaciones y los ganchos presentan un desgaste superior al 10% de su grosor original, deben sustituirse por las mismas fijaciones que se suministraron originalmente.
- 3) Compruebe el apriete de todas las tuercas y pernos y apriételes cuando sea necesario.

- 4) Compruebe todos los revestimientos en busca de pernos y bordes afilados y reemplácelos cuando sea necesario.
- 5) Los juguetes pueden derrumbarse o ser peligrosos si no se revisan regularmente.
- 6) El suelo sobre el que se coloca el producto debe controlarse periódicamente. Todos los elementos como piedras u otros objetos que puedan causar lesiones en caso de caída deben ser retirados. Se aconseja retirar el aparato durante el periodo invernal o cuando no se utilice, para evitar cualquier deterioro debido a las inclemencias meteorológicas.
- 7) Todos los equipos y/o piezas usados deben ser sustituidos por una pieza suministrada por nuestro servicio postventa.
- 8) Cualquier modificación realizada por el consumidor en el juguete de actividad original deberá realizarse según las instrucciones del fabricante.
- 9) Lije las zonas oxidadas y los elementos tubulares, y vuelva a pintar con una pintura sin plomo cuando sea necesario.

### CONSEJOS PRÁCTICOS

Las comprobaciones de seguridad de este producto deben llevarse a cabo con regularidad. Estas comprobaciones deben incluir, si es necesario, eliminar los bordes afilados, sustituir las tapas de los tornillos que falten y apretar las tuercas y los pernos. Estas comprobaciones deben realizarse para evitar cualquier peligro o vuelco debido al desgaste normal.

### ¡IMPORTANTE!

Espere a que el hormigón esté fraguado antes de utilizar el tobogán y compruebe los anclajes con regularidad. Los niños no deben saltar con fuerza en el tobogán.

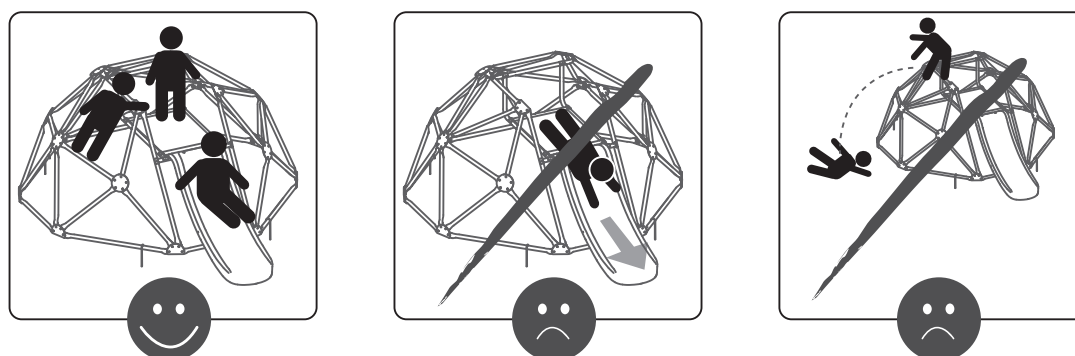

Persona de contacto  
Ibérica de Distribuciones online del Hogar,  
SLU,  
Méndez Álvaro 20,  
Madrid 28045,  
Teléfono: +34 912907933  
www.tectake.es  
correo electrónico: mail@idoh.es

# Struttura da Arrampicata per Bambini con Scivolo

IN CONFORMITÀ AI REQUISITI DI SICUREZZA

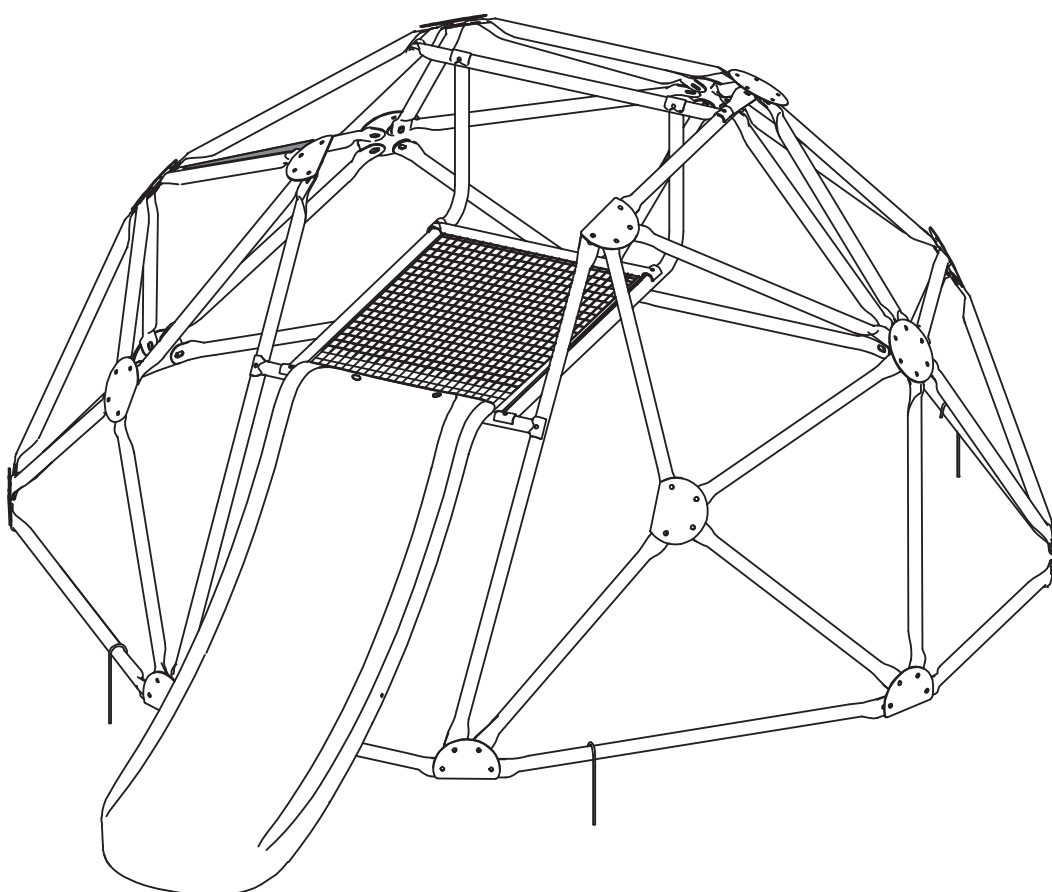





**STRUZIONI PER L'USO ORIGINALI**  
**Conservarle per poterle consultare all'occorrenza**







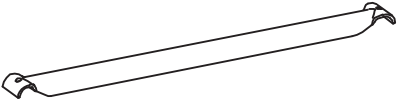

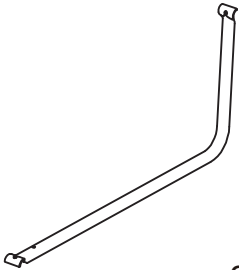

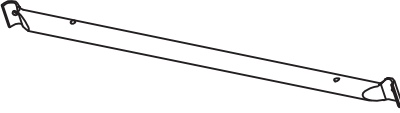
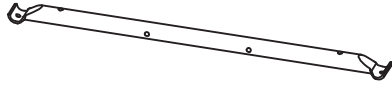
IT

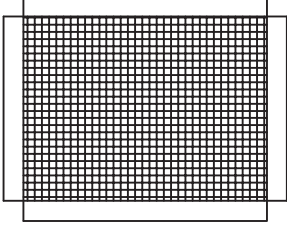
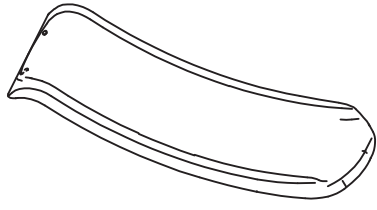
- ⚠ Pericolo! Tenere tutte le piccole parti e i materiali di imballaggio di questo prodotto lontano da neonati e bambini, altrimenti potrebbero rappresentare un rischio di soffocamento.
- ⚠ Il prodotto deve essere installato e utilizzato sotto la supervisione di un adulto.
- ⚠ Leggere attentamente ogni passo e seguire l'ordine corretto.
- ⚠ Rimuovere tutti gli imballaggi, separare e contare tutte le parti e tutti gli accessori.
- ⚠ Si prega di assicurarsi che tutte le parti siano installate correttamente, un'installazione errata può portare a un pericolo.
- ⚠ Si consiglia, ove possibile, di montare tutti gli articoli vicino alla zona in cui verranno posti in uso, per evitare di spostare inutilmente il prodotto una volta assemblato.
- ⚠ Garantire una superficie sicura durante il montaggio e posizionare il prodotto sempre su una superficie piana, stabile.

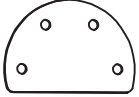
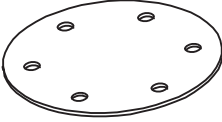
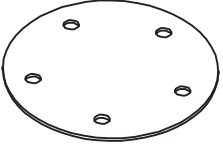
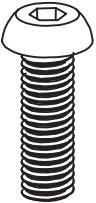
## LISTA DEI PEZZI

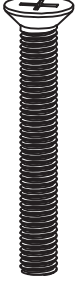
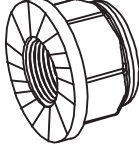
**Nota:** Alcuni di questi pezzi hanno pezzi di ricambio aggiuntivi.

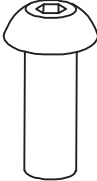
<p><b>A</b></p>  <p>blu 17pcs</p>	<p><b>B</b></p>  <p>rosso 18pcs</p>	<p><b>C</b></p>  <p>blu 4pcs</p>
<p><b>D</b></p>  <p>blu 1pc</p>	<p><b>E</b></p>  <p>blu 2pcs</p>	<p><b>F</b></p>  <p>blu 2pcs</p>

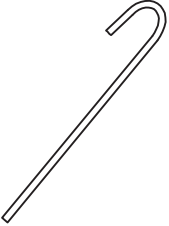
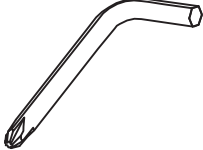
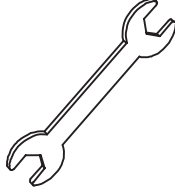
<p><b>G</b></p>  <p>blu 1pc</p>	<p><b>H</b></p>  <p>blu 1pc</p>	<p><b>Q</b></p>  <p>blu 2pcs</p>	
<p><b>I</b></p>  <p>1pc</p>	<p><b>P</b></p>  <p>1pc</p>	<p><b>D8</b></p>  <p>10pcs</p>	
<p><b>F1</b></p>  <p>12pcs</p>	<p><b>F2</b></p>  <p>3pcs</p>	<p><b>F3</b></p>  <p>4pcs</p>	
<p><b>Z10</b></p>  <p>M8x13 86pcs</p>	<p><b>Z14</b></p>  <p>M6x20 10pcs</p>	<p><b>Z15</b></p>  <p>M5x42 2pcs</p>	
<p><b>K</b></p>  <p>M8 86pcs</p>	<p><b>N</b></p>  <p>M5 2pcs</p>	<p><b>G8</b></p>  <p>10pcs</p>	
<p><b>L8</b></p>  <p>10pcs</p>	<p><b>O</b></p>  <p>4pcs</p>	<p><b>A5</b></p>  <p>2pcs</p>	<p><b>K1013</b></p>  <p>1pc</p>

# ASSEMBLAGGIO

1

Per prima cosa assemblare le 3 parti a forma di (\*) mostrate nella figura per utilizzarle nelle fasi di installazione successive. Le linee verdi rappresentano le parti necessarie per l'installazione attuale.

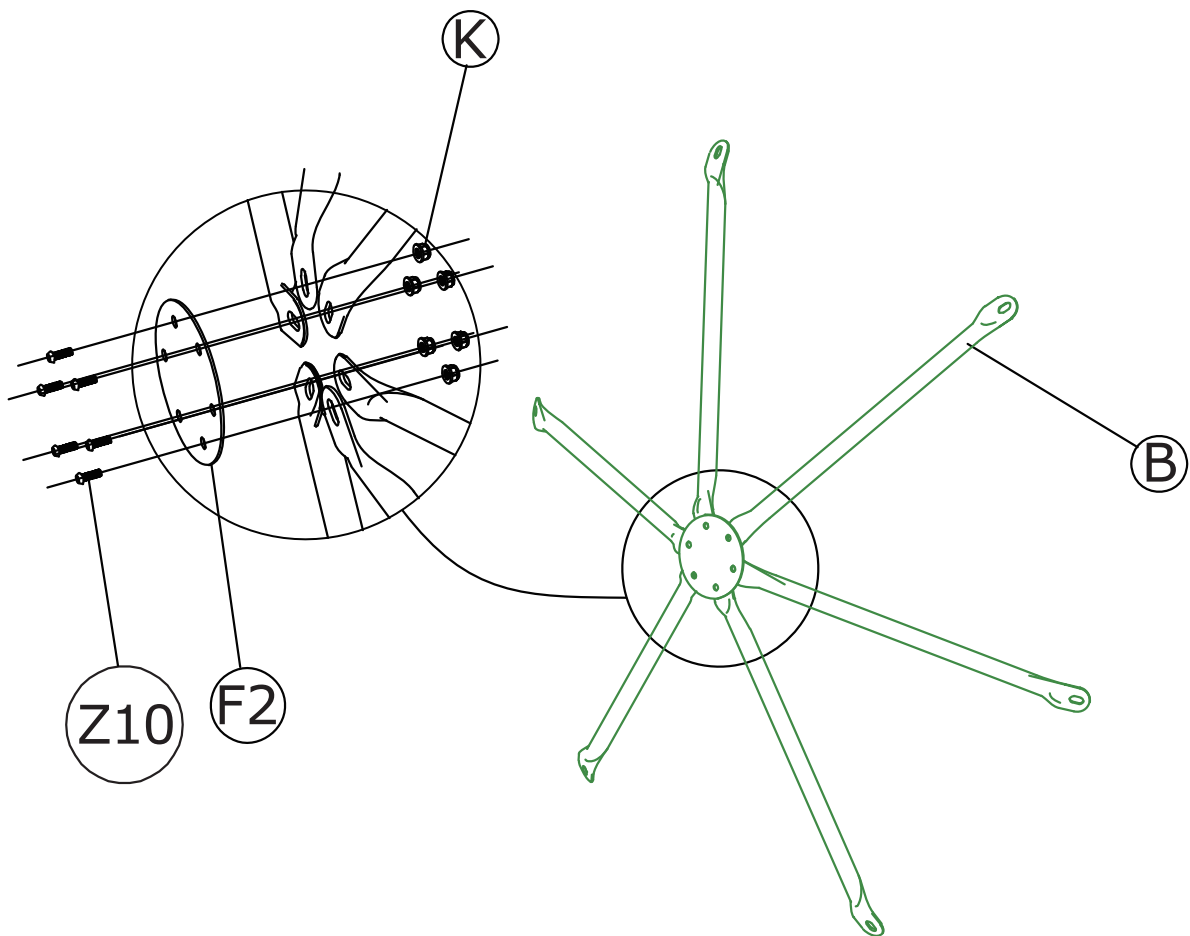

×3

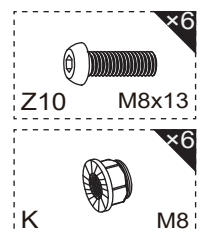

Con F1 collegare alternativamente A e C per formare un ottagono.

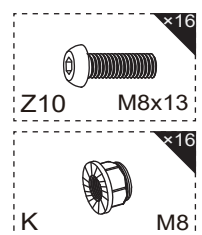
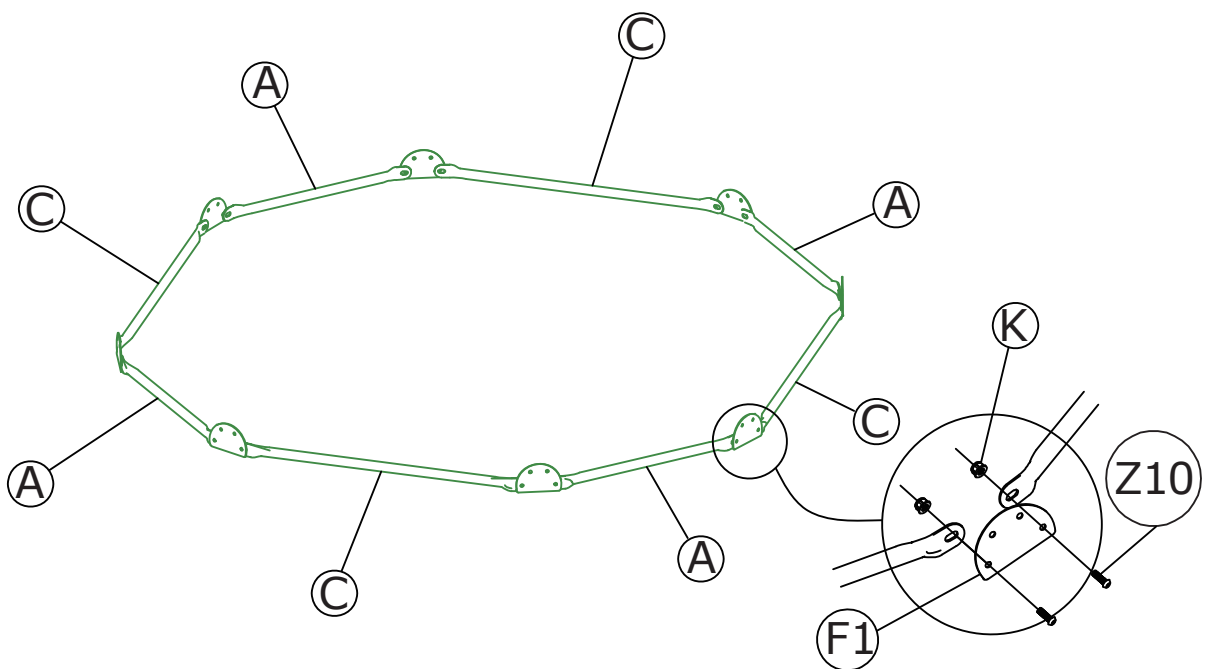
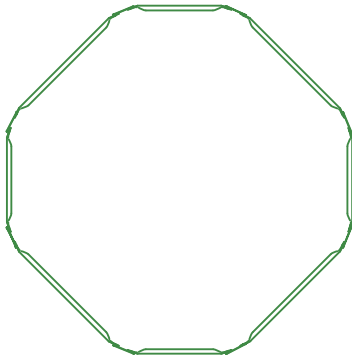

3

Utilizzare F1, F3, A e Q per collegare le parti di assemblaggio (\*) del primo passo e formare un esagono.

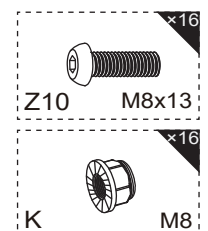
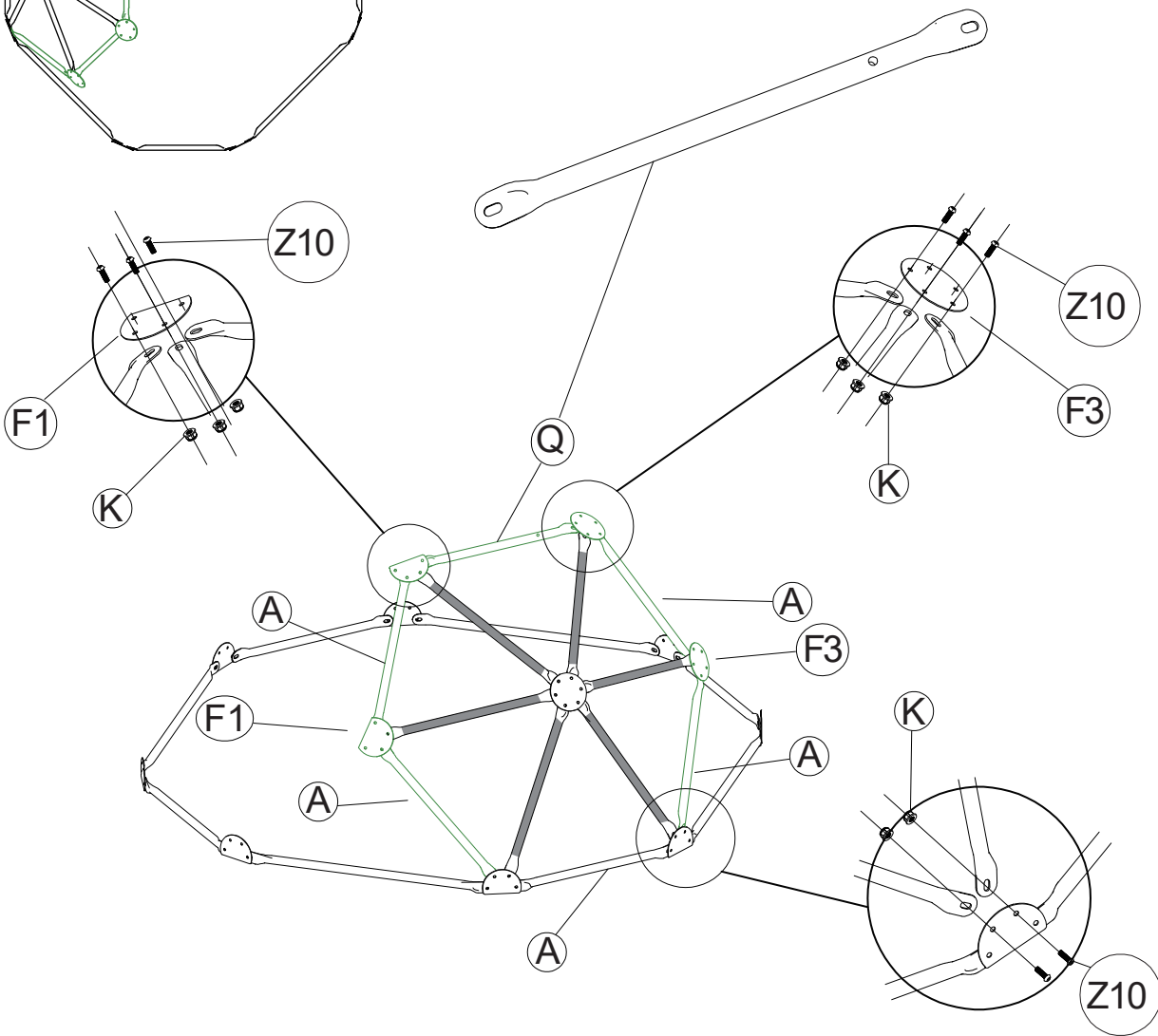
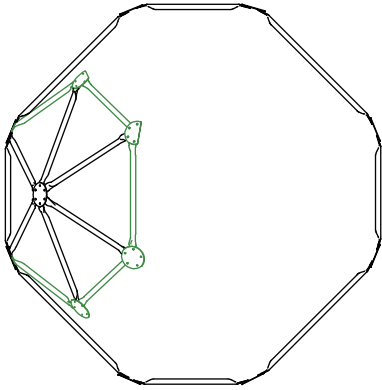

4

Utilizzare A e F3 per collegare le parti dell'assemblaggio (\*) nel primo passo e formare la struttura mostrata nell'immagine.

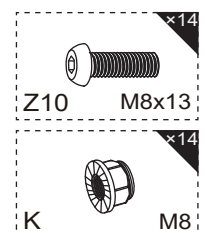
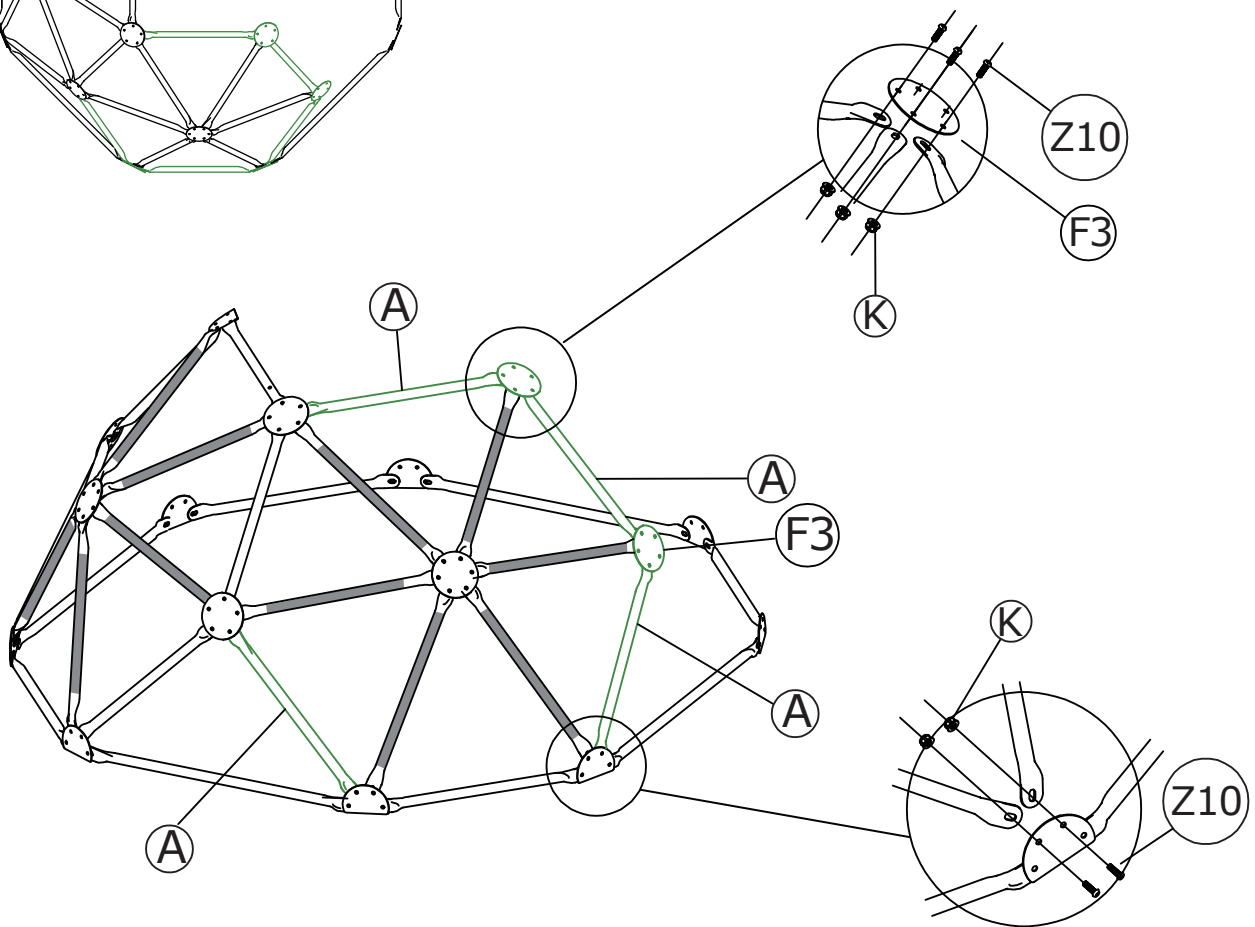
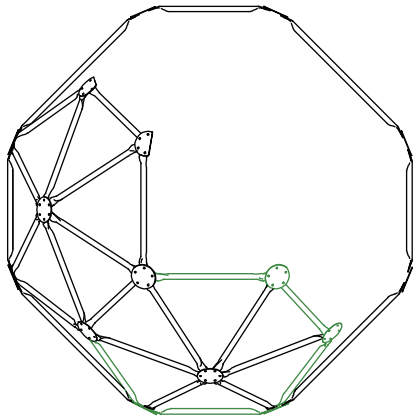

5

Utilizzare F1, A e Q per collegare le parti di  
assemblaggio (\*) nel primo passo. Prestare attenzione alla  
direzione di installazione di Q. Il foro centrale si trova vicino al  
lato sinistro dell'immagine.

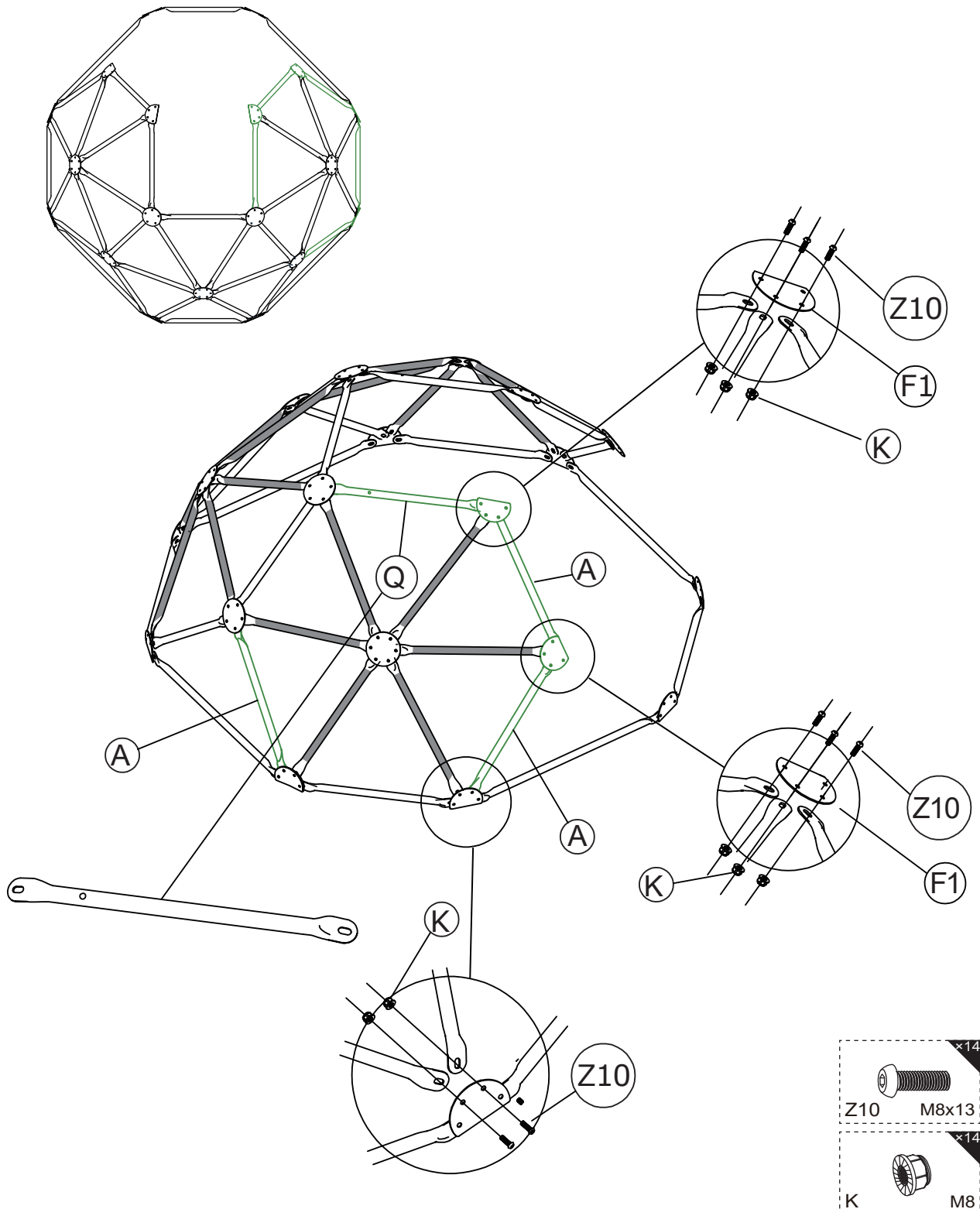

6

Quando si collegano A, E, H, G e H, tutti i fori devono essere rivolti verso l'alto e il lato corto del foro centrale di E è vicino al lato superiore.

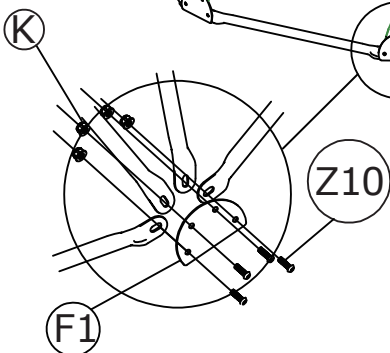
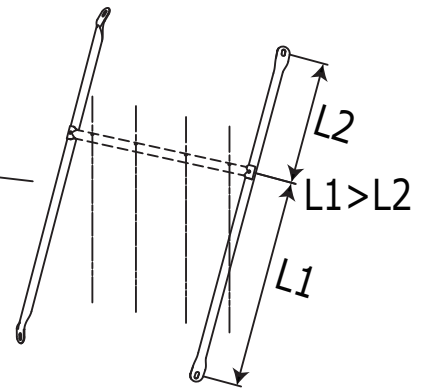
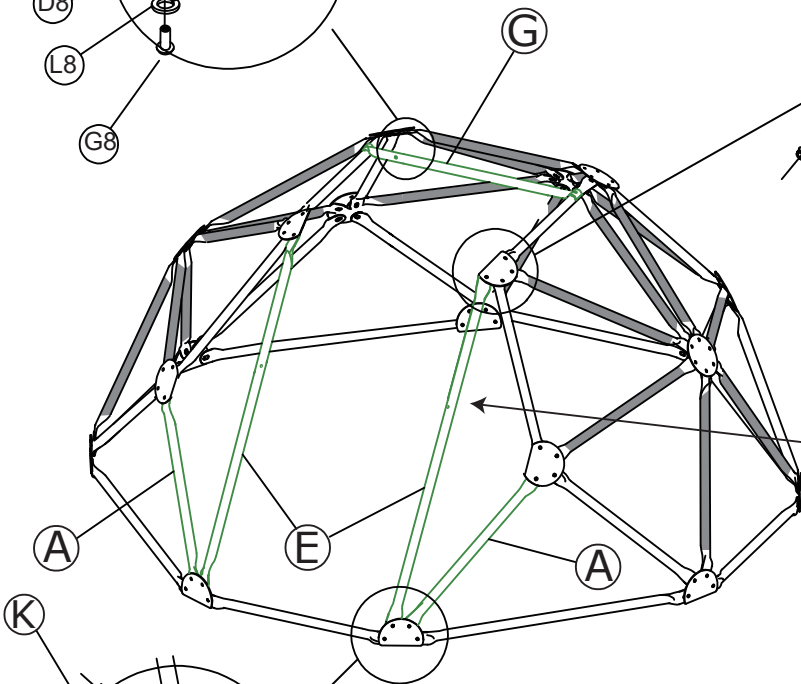
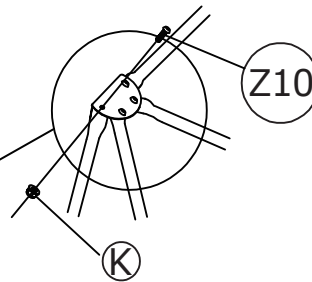
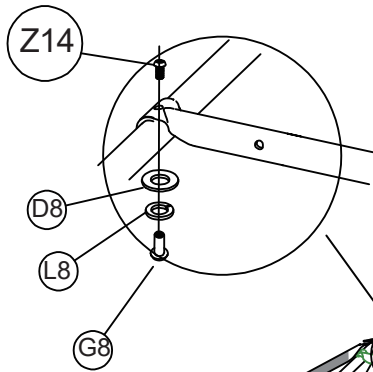
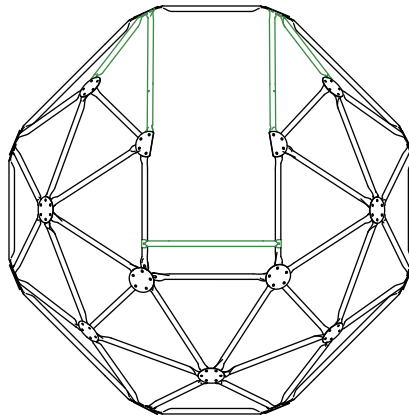

D8	x2	Z14	x2	M6x20	x2	G8	x2
Z10	x8	M8x13	x8	K	x8	M8	x2
						L8	x2

D,H e F devono essere fatti passare attraverso il tessuto e poi avvitati rispettivamente su G e H.

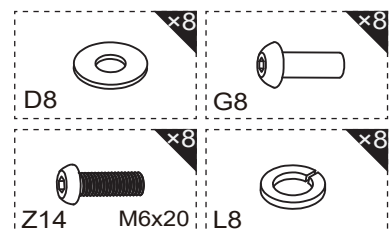
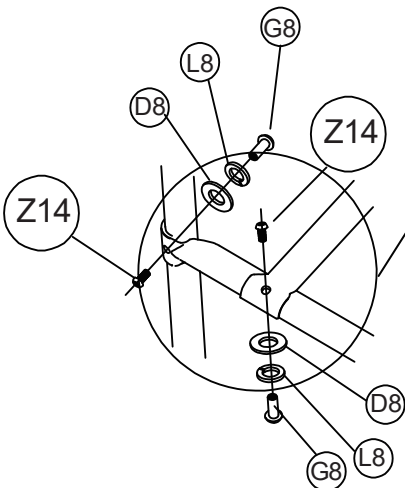
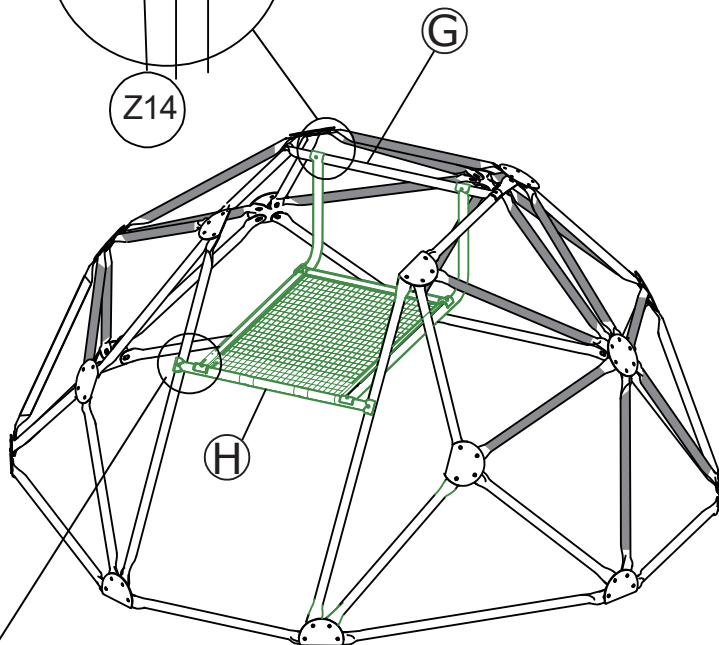
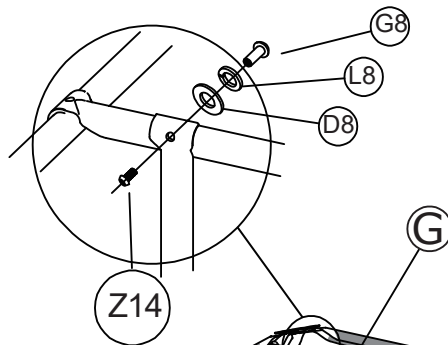
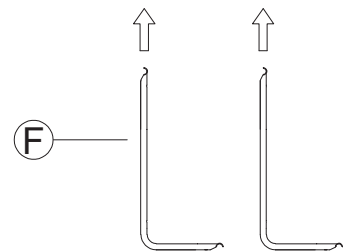
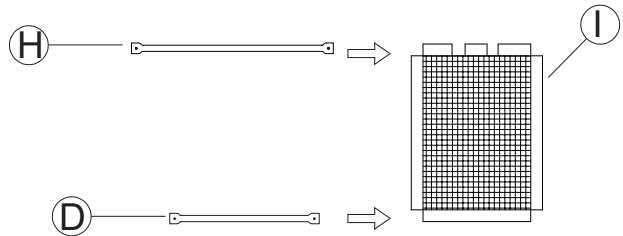
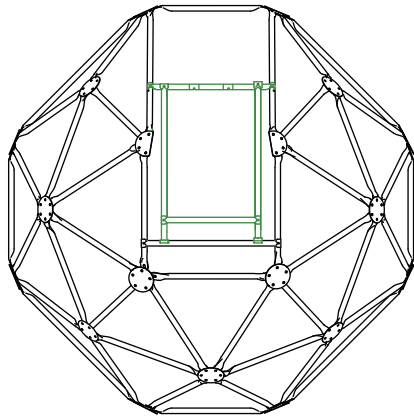

Installare lo scivolo su H e serrare le viti.

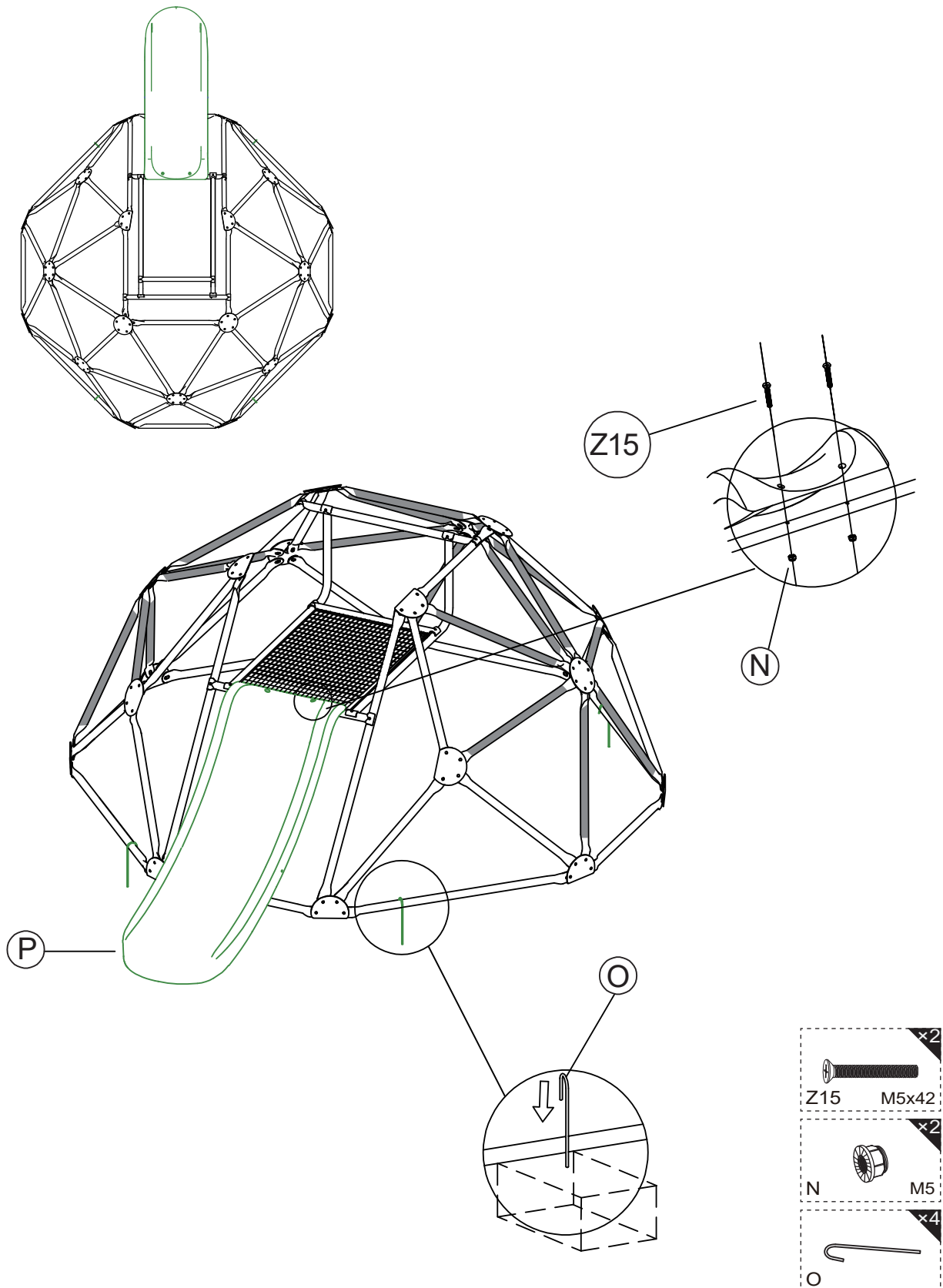

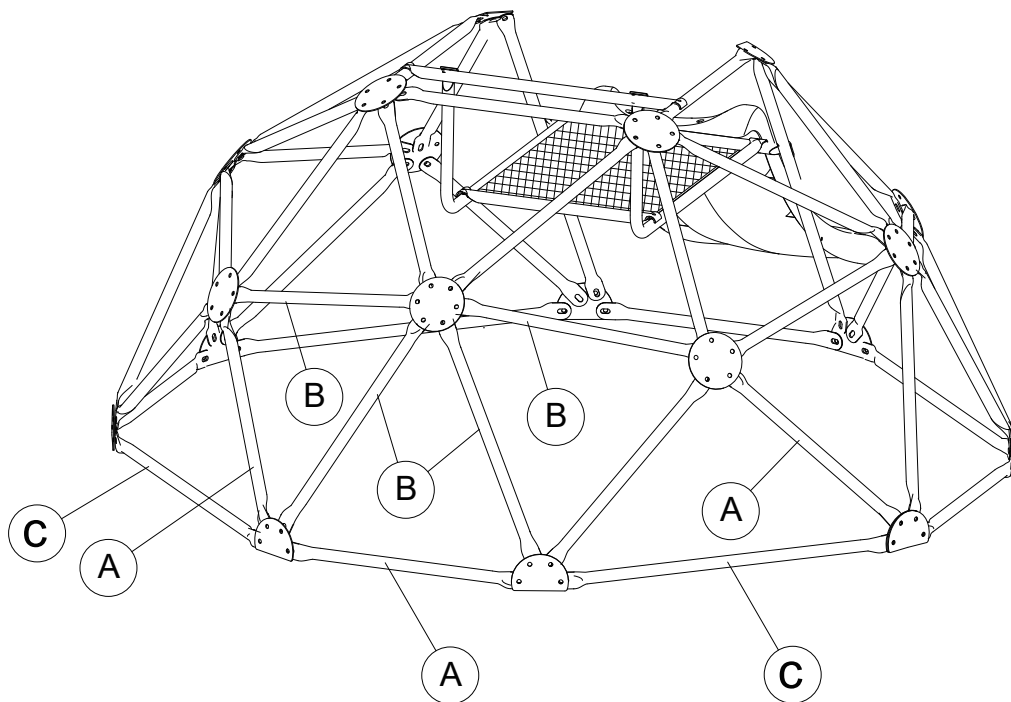
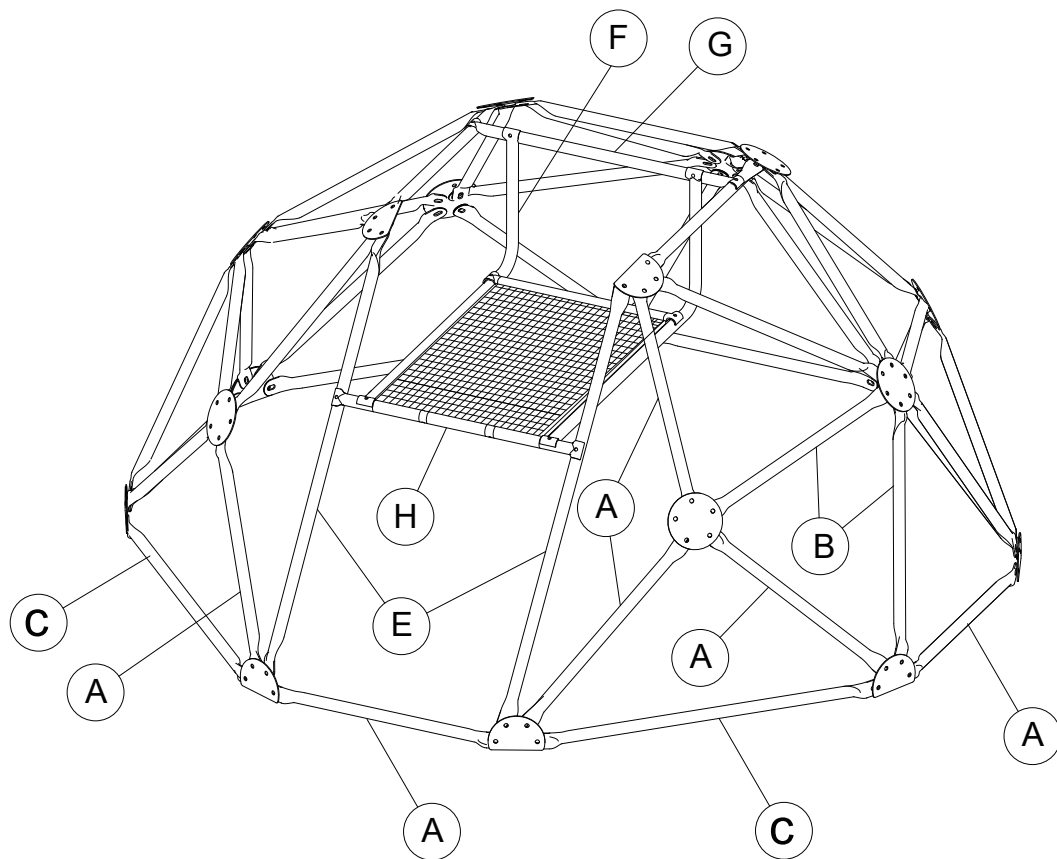

**Nota:** Stringere tutte le viti dopo aver completato tutto il montaggio.

## **ISTRUZIONI DI MONTAGGIO**

Conservare le istruzioni per riferimento futuro.

**ATTENZIONE:** Solo per uso residenziale all'esterno e all'interno.

**Gentile Cliente,**

Per garantire la sicurezza, prestare particolare attenzione alle istruzioni di montaggio, sicurezza e cura dettagliate in questo documento.

### **CONSIGLI DI MONTAGGIO**

Si prega di seguire le istruzioni di montaggio esattamente come indicato.

- 1) Questo prodotto deve essere assemblato da un adulto.
- 2) Conservare una copia delle istruzioni di montaggio per riferimento futuro. Ciò può essere particolarmente utile per l'identificazione delle parti nel caso in cui sia richiesto il servizio post-vendita.
- 3) Prima di iniziare, verificare che non manchino parti. Se trovi che manca qualche parte, contatta il nostro servizio post-vendita.
- 4) Smaltire l'imballo con cura.
- 5) Non lasciare che i bambini giochino con la confezione.
- 6) Si consiglia di non rivolgere lo scivolo verso il sole.

### **CONSIGLI DI SICUREZZA**

- 1) Questo prodotto non deve essere utilizzato da bambini di età inferiore a 36 mesi. È adatto solo a bambini di età compresa tra 3 e 12 anni con un peso massimo di 50 kg. Deve essere utilizzato sotto la supervisione di un adulto. Fino a 3 bambini possono giocare contemporaneamente.
- 2) Poiché questo prodotto contiene piccole parti che possono essere ingerite, tenere le parti lontano dalla portata dei bambini di età inferiore a 36 mesi.
- 3) Questo prodotto è solo per uso domestico privato e non deve mai essere utilizzato in parchi e giardini pubblici, scuole, campeggi, hotel, aree ricreative pubbliche, ecc.

- 4) Questo prodotto deve essere installato su una superficie piana a 2 m di distanza da altri oggetti, strutture o ostacoli (muri, recinzioni, alberi, stendibiancheria o linee elettriche, ecc.) che possono causare lesioni durante l'uso.
- 5) Questo prodotto non deve essere installato su superfici dure come cemento, asfalto o altre superfici dure. Si consiglia l'installazione su erba o altre superfici così morbide.
- 6) Questo prodotto deve essere saldamente incassato nel terreno. Si prega di seguire attentamente le istruzioni per farlo. Utilizzare questo prodotto solo quando il calcestruzzo è asciutto.
- 7) Le ancore devono essere posizionate a livello del suolo o sotto il livello del suolo per ridurre i rischi di inciampo.
- 8) L'ancoraggio deve essere controllato regolarmente, oltre ai ganci e ai fissaggi.
- 9) Smaltire con cura l'imballo.
- 10) Non permettere ai bambini di giocare con l'imballo.
- 11) Durante il montaggio, tenere i bambini lontani dal prodotto per evitare che piccoli accessori vengano ingeriti.

## **MANUTENZIONE**

- 1) Tutte le parti metalliche sono in acciaio zincato e verniciate a polvere per proteggere dalla ruggine. Tuttavia, in alcune zone vicino al mare, si consiglia di richiedere un trattamento aggiuntivo per prevenire l'ossidazione.
- 2) Le superfici di tutte le parti devono essere controllate almeno una volta al mese, in particolare i fissaggi come i ganci della trave superiore. Se gli elementi di fissaggio e i ganci presentano un'usura superiore al 10% del loro spessore originale, devono essere sostituiti con gli stessi elementi di fissaggio originariamente forniti.
- 3) Controllare il serraggio di tutti i dadi e bulloni e serrare se necessario.
- 4) Controllare tutti i rivestimenti per bulloni e spigoli vivi e sostituirli se necessario.

- 5) I giocattoli possono crollare o essere pericolosi se non controllati regolarmente.
- 6) Il terreno su cui è posizionato il prodotto deve essere controllato regolarmente. Tutti gli elementi come pietre o altri oggetti che potrebbero causare lesioni in caso di caduta devono essere rimossi. Si consiglia di rimuovere l'apparecchio durante il periodo invernale o quando non viene utilizzato, per evitare il deterioramento dovuto alle cattive condizioni atmosferiche.
- 7) Tutte le apparecchiature e/o parti usate devono essere sostituite con una parte fornita dal nostro servizio post-vendita.
- 8) Eventuali modifiche apportate dal consumatore al gioco di attività originale devono essere apportate secondo le istruzioni del produttore.
- 9) Carteggiare le aree arrugginite e gli elementi tubolari e ridipingere con una vernice senza piombo quando necessario.

### **CONSIGLI PRATICI**

I controlli di sicurezza per questo prodotto devono essere effettuati regolarmente. Questi controlli dovrebbero includere, se necessario, la rimozione degli spigoli vivi, la sostituzione dei cappucci dei bulloni mancanti e il serraggio di dadi e bulloni. Tali controlli devono essere effettuati per evitare qualsiasi pericolo o ribaltamento dovuto alla normale usura.

### **IMPORTANTE!**

Prima di utilizzare lo scivolo, attendere l'indurimento del calcestruzzo e controllare regolarmente gli ancoraggi. I bambini non devono saltare con forza sullo scivolo.

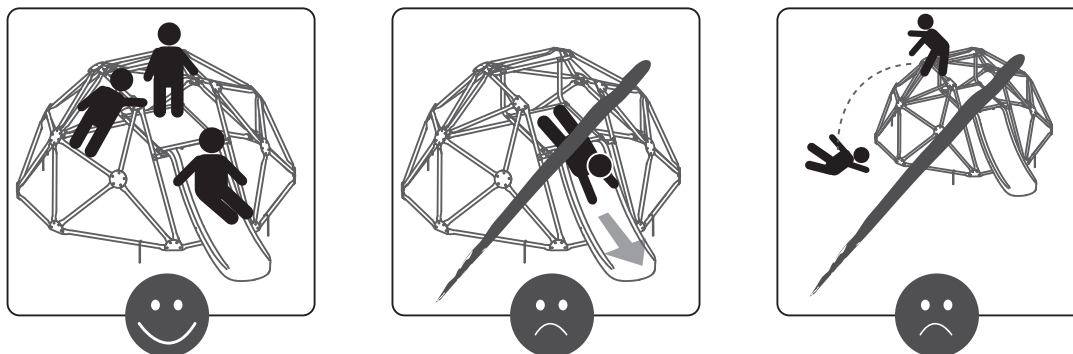

Persona di contatto  
tenulodi S.r.l.  
Via Manzano 70  
33040 Premariacco (UD)  
Numero di telefono: +39 0471 1800175  
www.tectake.it  
E-Mail: mail@tectake.it