

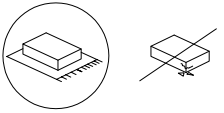





 15'

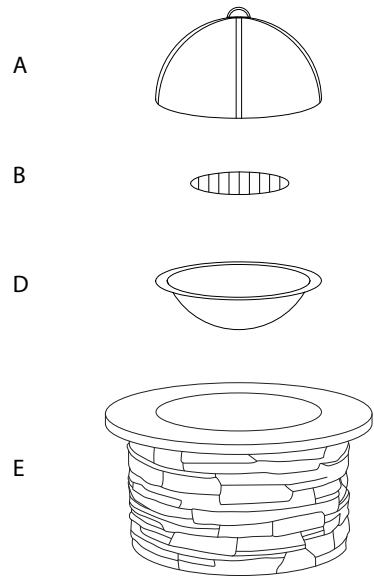

 2

1/4

1233/TAMBORA/281021/





A	B	D	E	F
				
x1	x1	x1	x1	x1

2/4

1233/TAMBORA/281021/

1

	
x1	x1

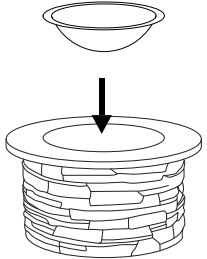

D

E

3

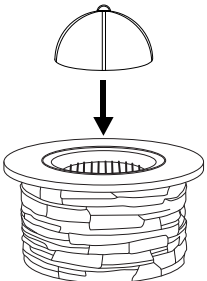

x1



A

E

2

x1

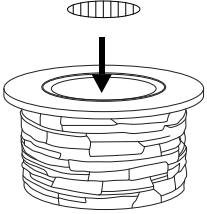

B

E

3/4

1233/TAMBORA/281021/

4/4

1233/TAMBORA/281021/