

**INSTRUCTION MANUAL/BEDIENUNGSANLEITUNG / NOTICE D'UTILISATION/
MANUAL DE INSTRUCCIONES DE USO/MANUALE DI ISTRUZIONI**

! WARNING!

Adults assembly required.
During assembly, keep all
parts away from children.
Check regularly to ensure
all fasteners are tight.

! WARNUNG!

Die Montage ist von
Erwachsenen durchzuführen.
Halten Sie während der
Montage alle Teile von Kindern
fern.
Überprüfen Sie regelmäßig
den festen Sitz der Schrauben.

! Attention!

Montage à effectuer par
des adultes.
Pendant le montage, tenez
les éléments
éloignés des enfants.
Vérifiez régulièrement que
toutes les vis
soient serrées.

! ¡Atención!

Se requiere que el montaje sea
llevado a cabo por un adulto.
Durante el montaje, mantenga
todas las piezas fuera del
alcance de los niños.
Verifique regularmente que
todos los tornillos estén
correctamente apretados.





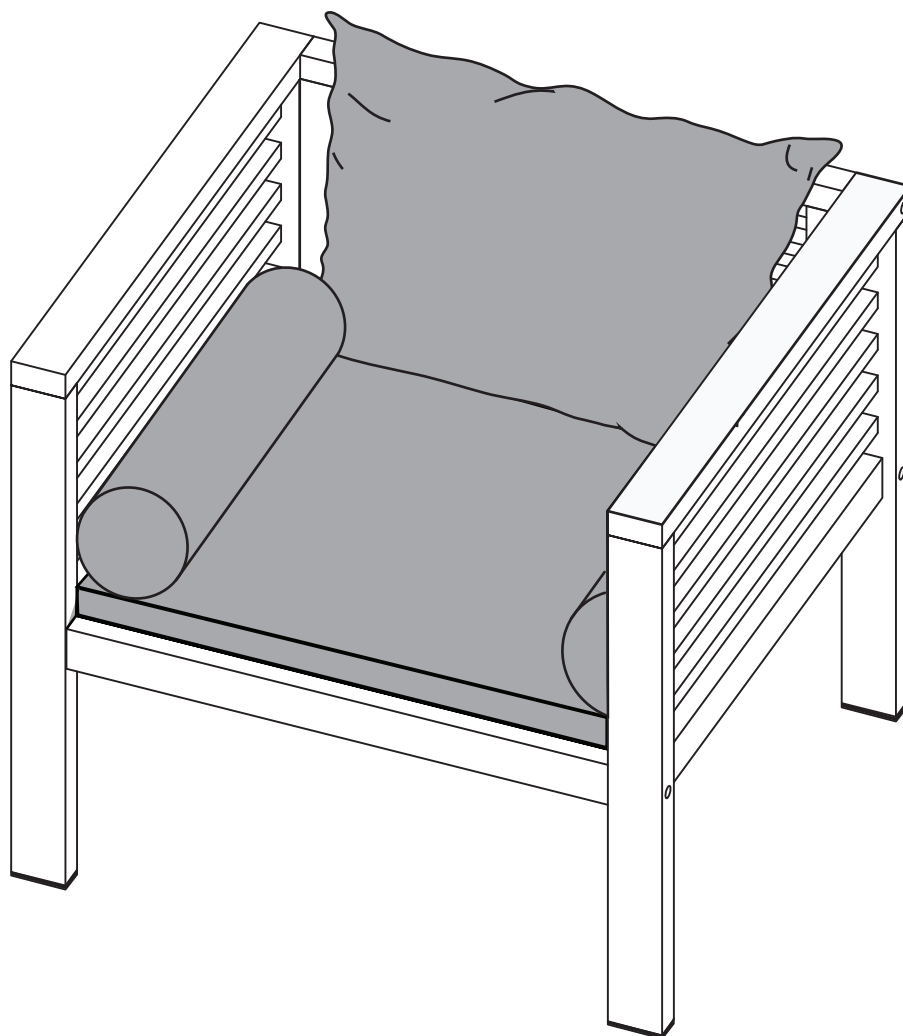



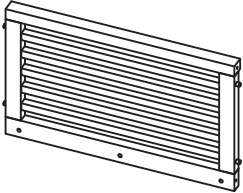
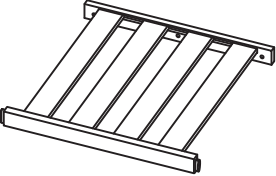
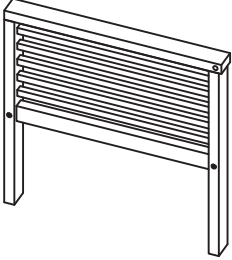
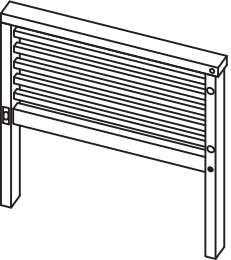

! Avvertimento!

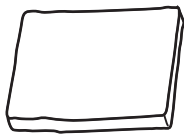
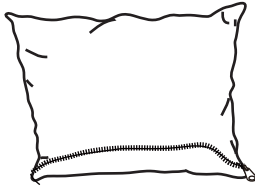
L'assemblaggio deve essere
effettuato da adulti.
Durante il montaggio
mantenere tutti i pezzi lontano
dalla portata dei bambini.
Controllare regolarmente per
assicurarsi che tutte le
chiusure siano ben strette.

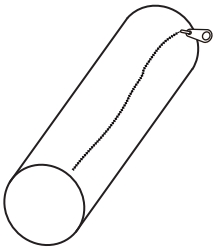
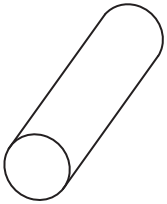

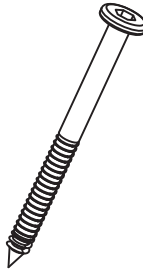
RETAIN FOR FUTURE REFERENCE
FÜR KÜNFTIGE VERWENDUNG AUFBEWAHREN
A CONSERVER POUR UNE UTILISATION FUTURE
CONSERVAR PARA SER LEÍDO POR CADA NUEVO USUARIO,
ANTES DE UTILIZAR EL ARTÍCULO POR PRIMERA VEZ
CONSERVARE PER CONSULTAZIONI FUTURE
SHRANITE ZA KASNEJŠO UPORABO

PARTS LIST/STÜCKLISTE/PARTS LIST/LISTA DE PIEZAS/LISTA DEI PEZZI

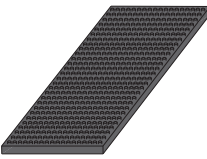
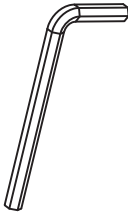
<p>A</p>  <p>1pc</p>	<p>B</p>  <p>1pc</p>	<p>C1</p>  <p>1pc</p>	
<p>C2</p>  <p>1pc</p>	<p>X1</p>  <p>1pc</p>	<p>X2</p>  <p>1pc</p>	
<p>Y1</p>  <p>1pc</p>	<p>Y2</p>  <p>1pc</p>	<p>Z1</p>  <p>2pcs</p>	
<p>Z2</p>  <p>2pcs</p>	<p>D</p>  <p>M6x40 3pcs</p>	<p>E</p>  <p>M6x65 6pcs</p>	<p>F</p>  <p>3pcs</p>
<p>G</p>  <p>3pcs</p>	<p>H</p>  <p>6pcs</p>	<p>I</p>  <p>4pcs</p>	<p>J</p>  <p>1pc</p>

EN: pre-assembled
 DE: vormontiert
 FR: préassemblée
 ES: Preensablado
 IT: preassemblato

ASSEMBLY/MONTAGE/ASSEMBLAGE/MONTAJE/ASSEMBLAGGIO

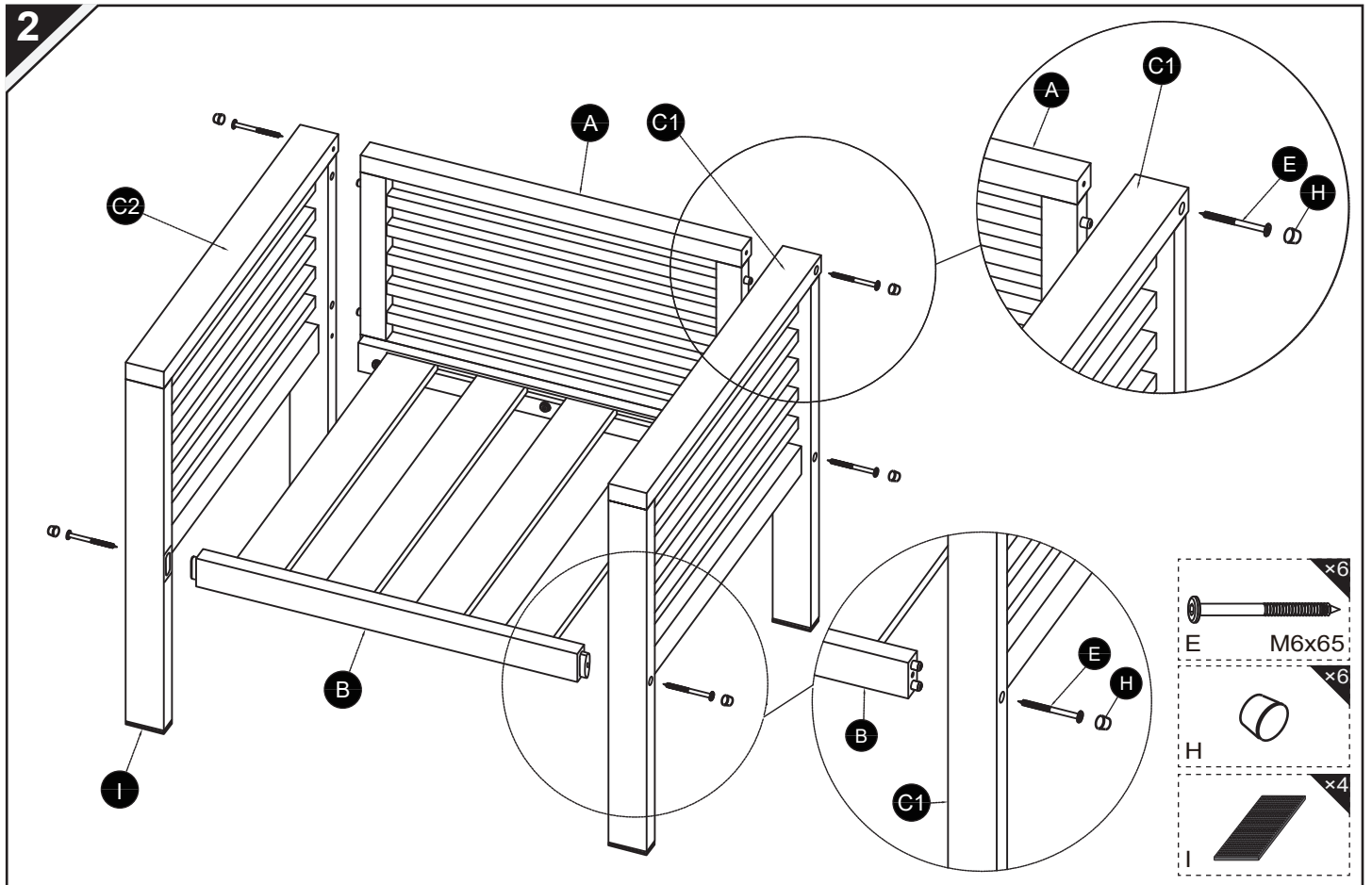
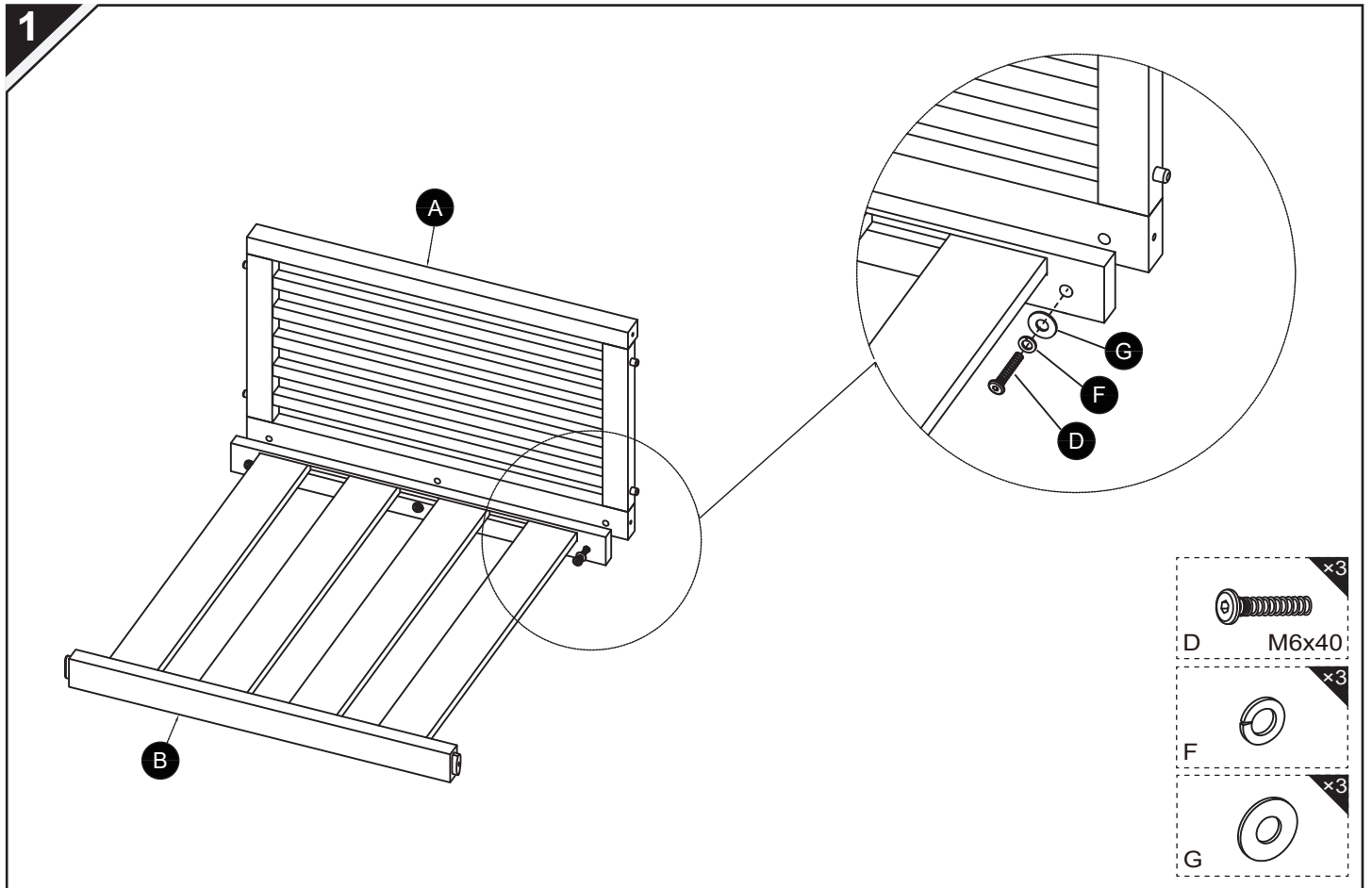

3

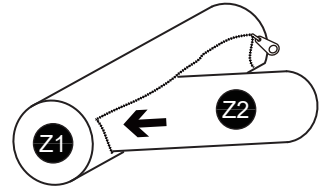
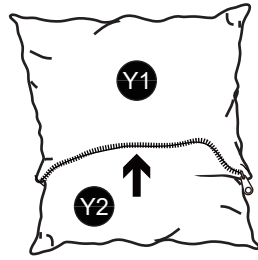
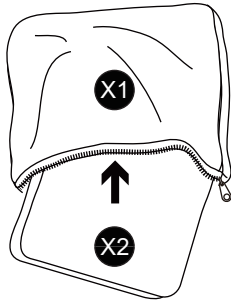

4

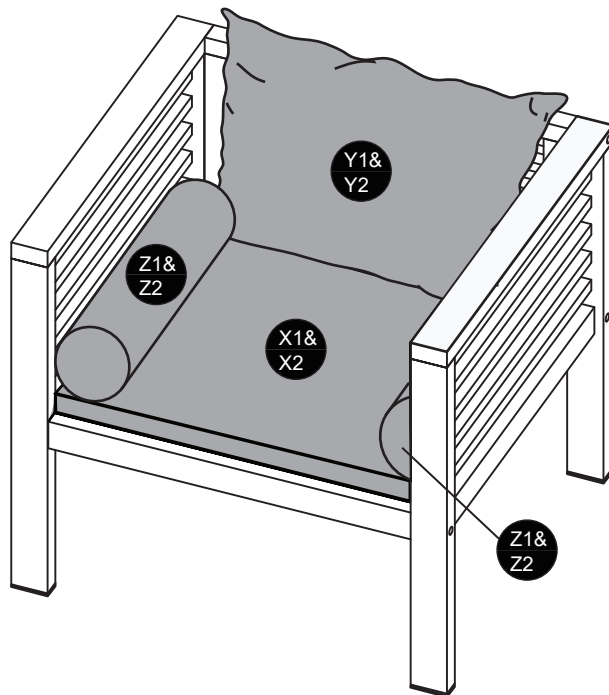

Contact person
tectake Ltd.
Mappin House
4 Winsley Street
W1W 8HF London ,UK
Telephone: +44 203488 4565
www. tectake.co.uk
mail@tectake.co.uk

Ansprechpartner
tectake GmbH
Tauberweg 41
97999 Igersheim
Telefon: +49 7931 991 920
www.tectake.de
E-Mail: verkauf@tectake.de

Personne de contact
Made4Home SAS
137 av. Gustave Eiffel
ZI Rognac Nord
13340 Rognac (France)
téléphone au: +33 4 42 81 81 80
www.tectake.fr
E-Mail: contact@tectake.fr

Persona de contacto
Ibérica de Distribuciones online del Hogar,
SLU,
Méndez Álvaro 20,
Madrid 28045,
Teléfono: +34 912907933
www.tectake.es
correo electrónico: mail@idoh.es

Persona di contatto
tenulodi S.r.l.
Via Manzano 70
33040 Premariacco (UD)
Numero di telefono: +39 0471 1800175
www.tectake.it
E-Mail: mail@tectake.it

Kontaktní osoba
TecTake s.r.o.
se sídlem na adrese Lidická 700 / 19, Veverří,
602 00 Brno, Česká republika
+420 538 880 441
www.tectake.cz
E-Mail: mail@tectake.cz