

**INSTRUCTION MANUAL/BEDIENUNSANLEITUNG/NOTICE D'UTILISATION/
MANUAL DE INSTRUCCIONES DE USO/MANUALE DI ISTRUZIONI**

! WARNING!

Adults assembly required.
During assembly, keep all
parts away from children.
Check regularly to ensure
all fasteners are tight.

! WARNUNG!

Die Montage ist von
Erwachsenen durchzuführen.
Halten Sie während der
Montage alle Teile von Kindern
fern.
Überprüfen Sie regelmäßig
den festen Sitz der Schrauben.

! Attention!

Montage à effectuer par
des adultes.
Pendant le montage, tenez
les éléments
éloignés des enfants.
Vérifiez régulièrement que
toutes les vis
soient serrées.

! ¡Atención!

Se requiere que el montaje sea
llevado a cabo por un adulto.
Durante el montaje, mantenga
todas las piezas fuera del
alcance de los niños.
Verifique regularmente que
todos los tornillos estén
correctamente apretados.





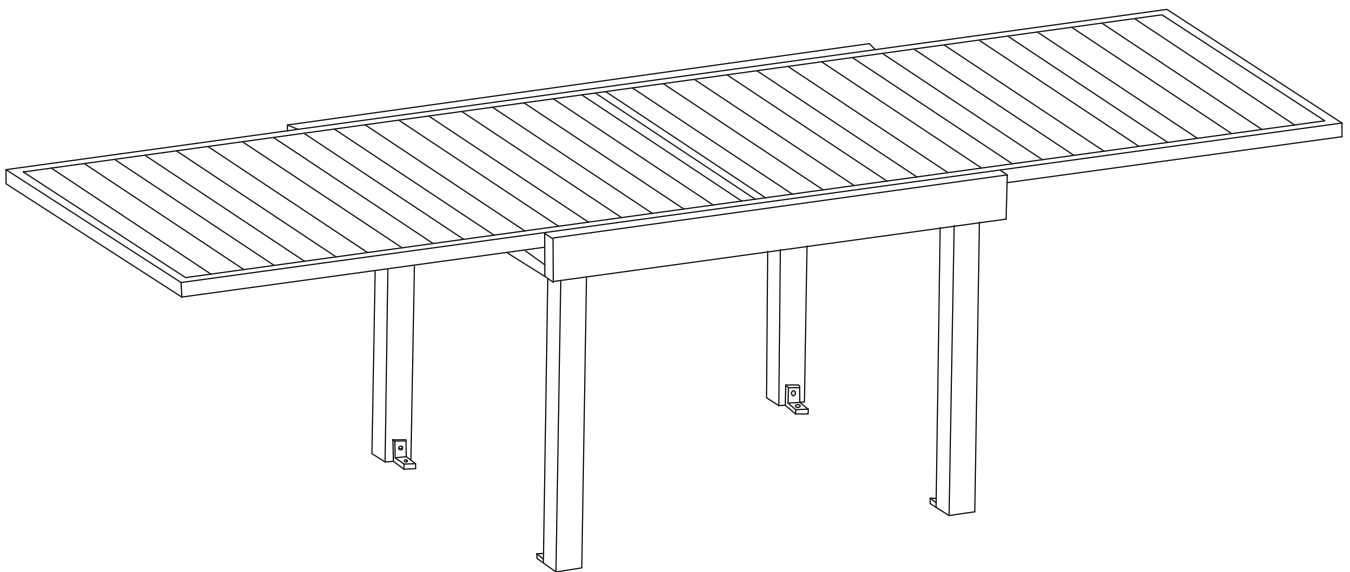

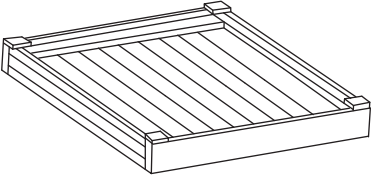
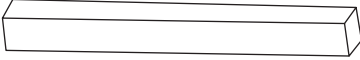

! Avvertimento!

L'assemblaggio deve essere
effettuato da adulti.
Durante il montaggio
mantenere tutti i pezzi lontano
dalla portata dei bambini.
Controllare regolarmente per
assicurarsi che tutte le
chiusure siano ben strette.

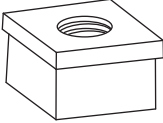
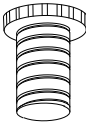
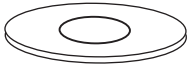
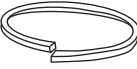

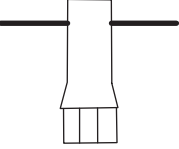
**RETAIN FOR FUTURE REFERENCE
FÜR KÜNFTIGE VERWENDUNG AUFBEWAHREN
A CONSERVER POUR UNE UTILISATION FUTURE
CONSERVAR PARA SER LEÍDO POR CADA NUEVO USUARIO,
ANTES DE UTILIZAR EL ARTÍCULO POR PRIMERA VEZ
CONSERVARE PER CONSULTAZIONI FUTURE**

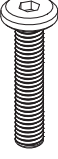
PARTS LIST/STÜCKLISTE/PARTS LIST/LISTA DE PIEZAS/LISTA DEI PEZZI

<p>A</p>  <p>1pc</p>	<p>B</p>  <p>4pcs</p>	<p>C</p>  <p>4pcs</p>	
<p>D</p>  <p>EN: pre-assembled DE: vormontiert FR: préassemblée ES: Preensamblado IT: preassemblato</p> <p>4pcs</p>	<p>E</p>  <p>4pcs</p>	<p>F</p>  <p>8pcs</p>	
<p>G</p>  <p>M10</p> <p>8pcs</p>	<p>H</p>  <p>M10</p> <p>8pcs</p>	<p>I</p>  <p>1pc</p>	
<p>J</p>  <p>4pcs</p>	<p>K</p>  <p>4pcs</p>	<p>L</p>  <p>M6x20</p> <p>4pcs</p>	<p>M</p>  <p>1pc</p>

1

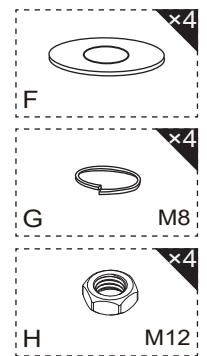
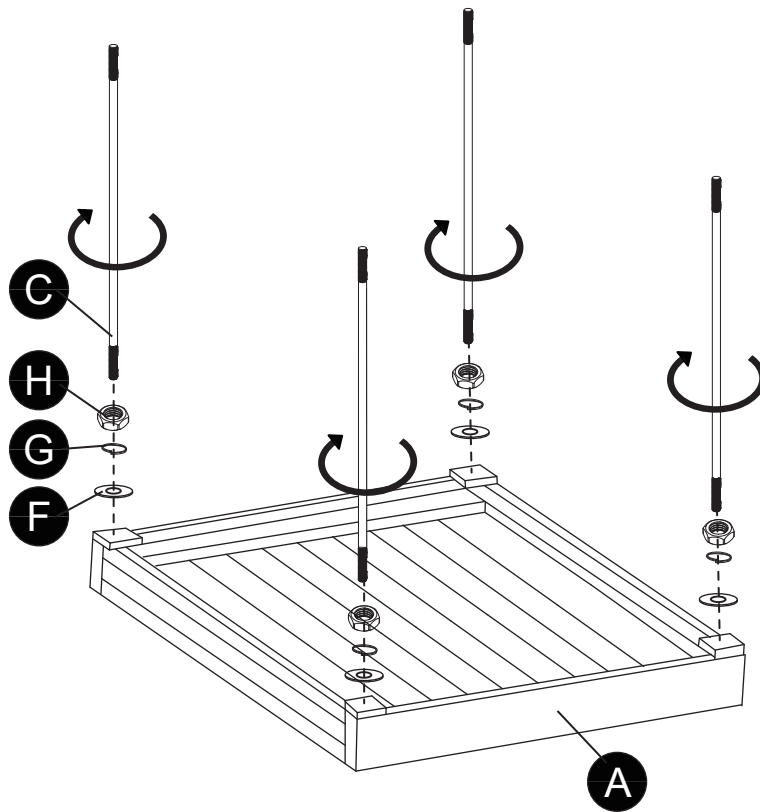

2

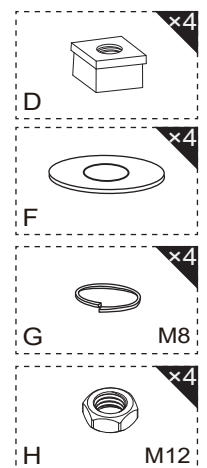
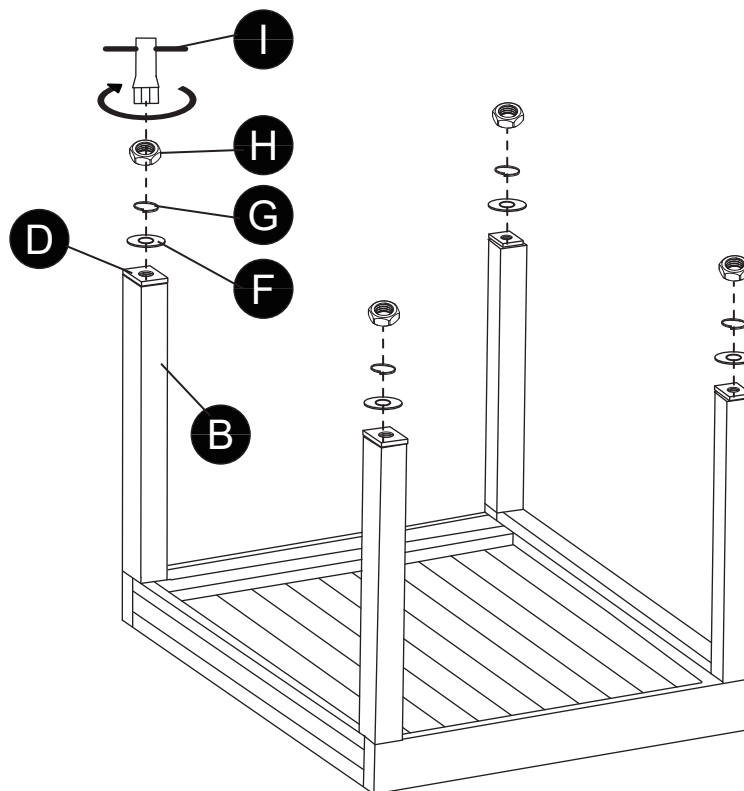

3

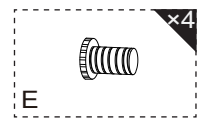
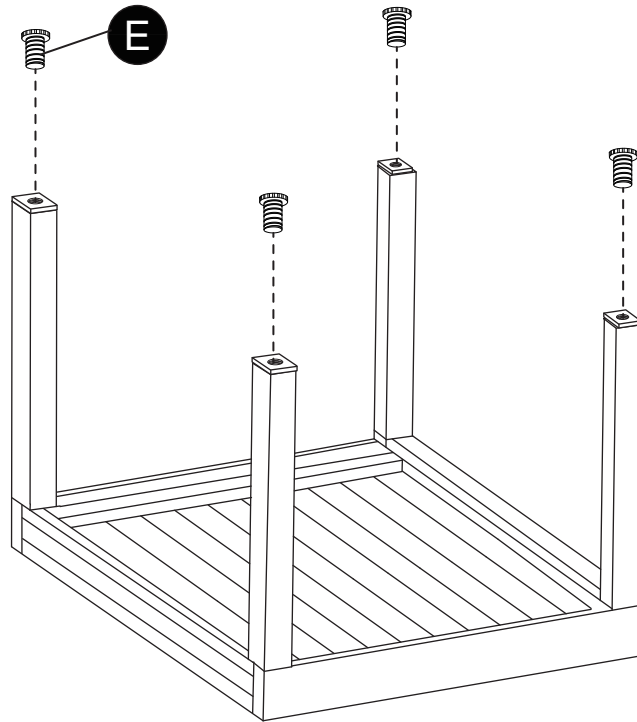

4

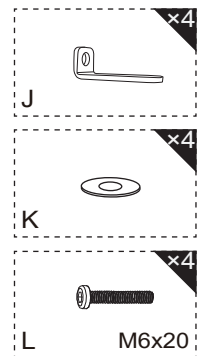
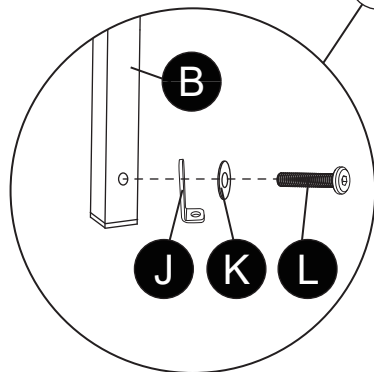
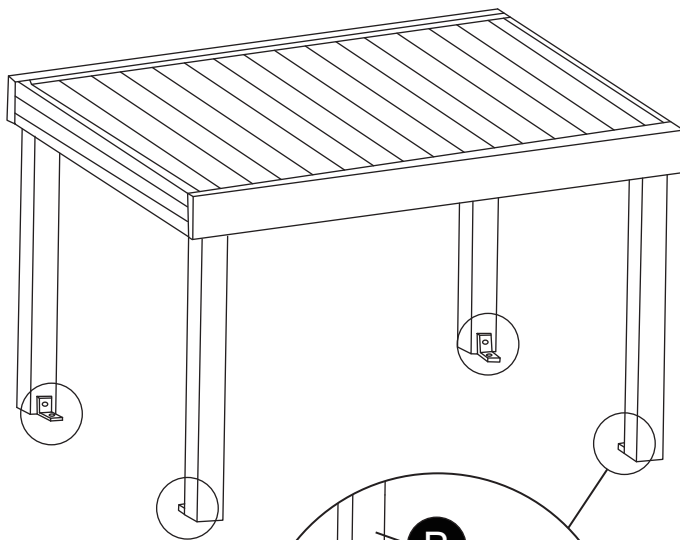

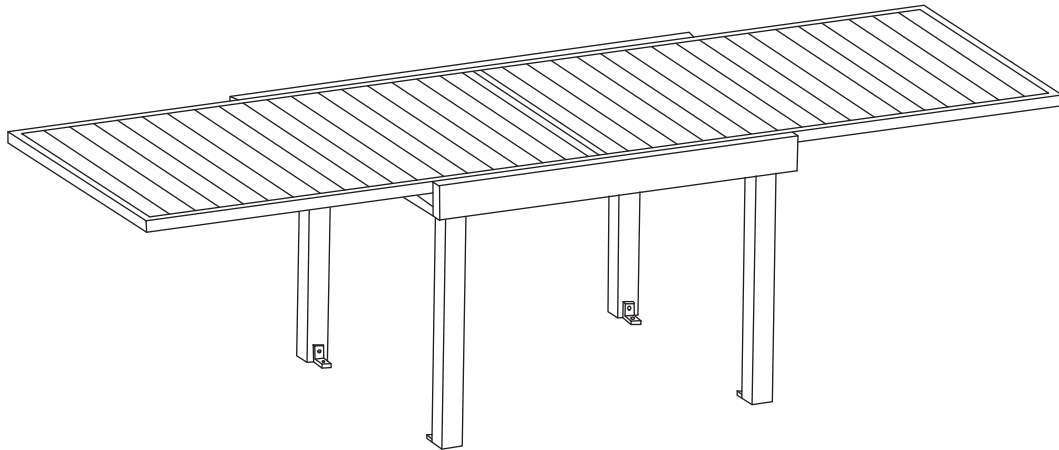

Contact person
tectake Ltd.
Mappin House
4 Winsley Street
W1W 8HF London ,UK
Telephone: +44 203488 4565
www. tectake.co.uk
mail@tectake.co.uk

Ansprechpartner
tectake GmbH
Tauberweg 41
97999 Igersheim
Telefon: +49 7931 991 920
www.tectake.de
E-Mail: verkauf@tectake.de

Personne de contact
Made4Home SAS
137 av. Gustave Eiffel
ZI Rognac Nord
13340 Rognac (France)
téléphone au: +33 4 42 81 81 80
www.tectake.fr
E-Mail: contact@tectake.fr

Persona de contacto
Ibérica de Distribuciones online del Hogar,
SLU,
Méndez Álvaro 20,
Madrid 28045,
Teléfono: +34 912907933
www.tectake.es
correo electrónico: mail@idoh.es

Persona di contatto
tenulodi S.r.l.
Via Manzano 70
33040 Premariacco (UD)
Numero di telefono: +39 0471 1800175
www.tectake.it
E-Mail: mail@tectake.it

Kontaktní osoba
TecTake s.r.o.
se sídlem na adrese Lidická 700 / 19, Veverří,
602 00 Brno, Česká republika
+420 538 880 441
www.tectake.cz
E-Mail: mail@tectake.cz