

# CASANOVO

## VEYMONT 350B140

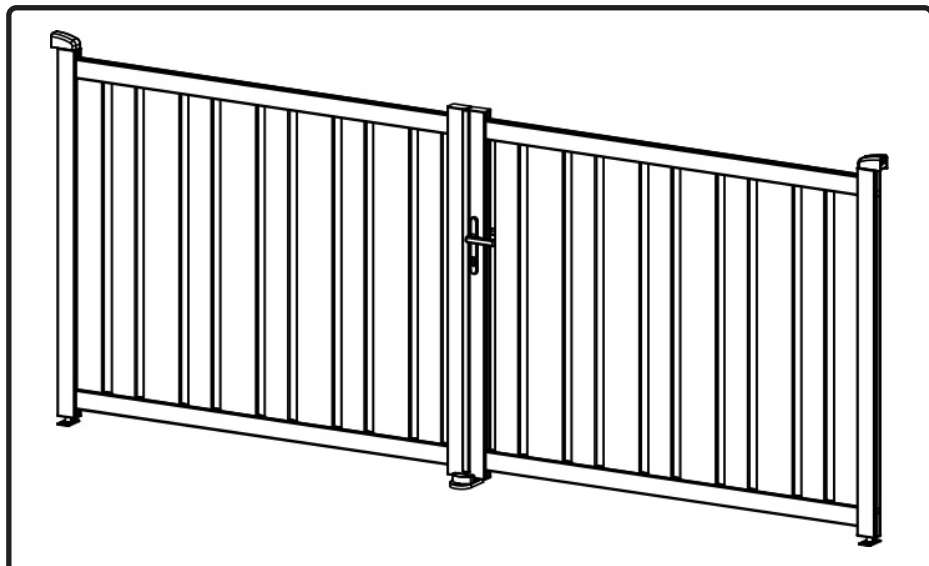

COM-000828 [x1]

COM-000829 [x1]



5-7H



X 2





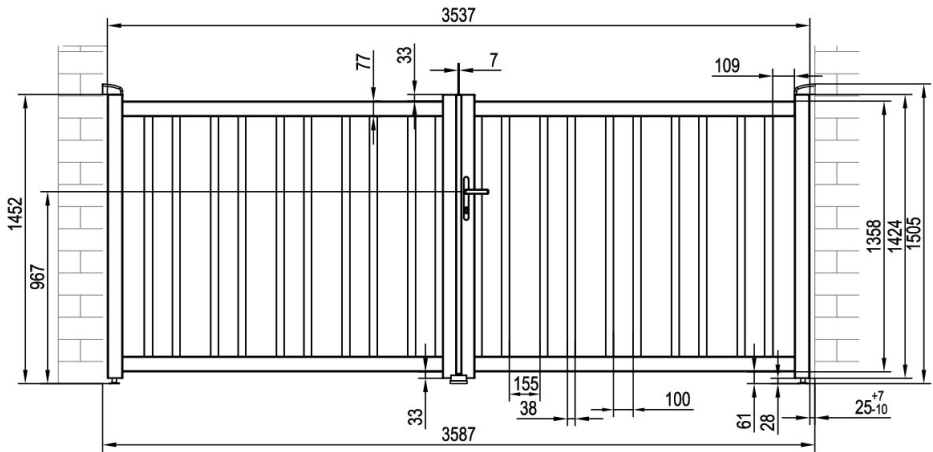

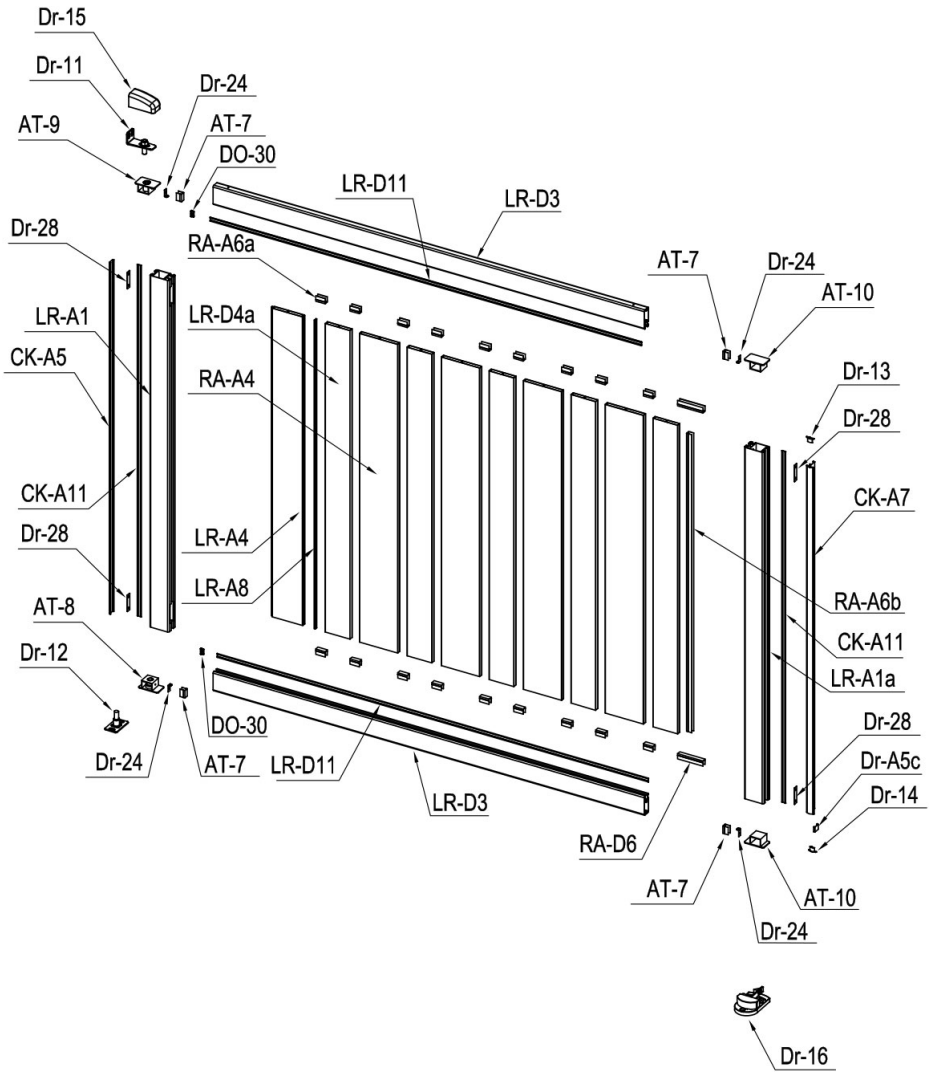

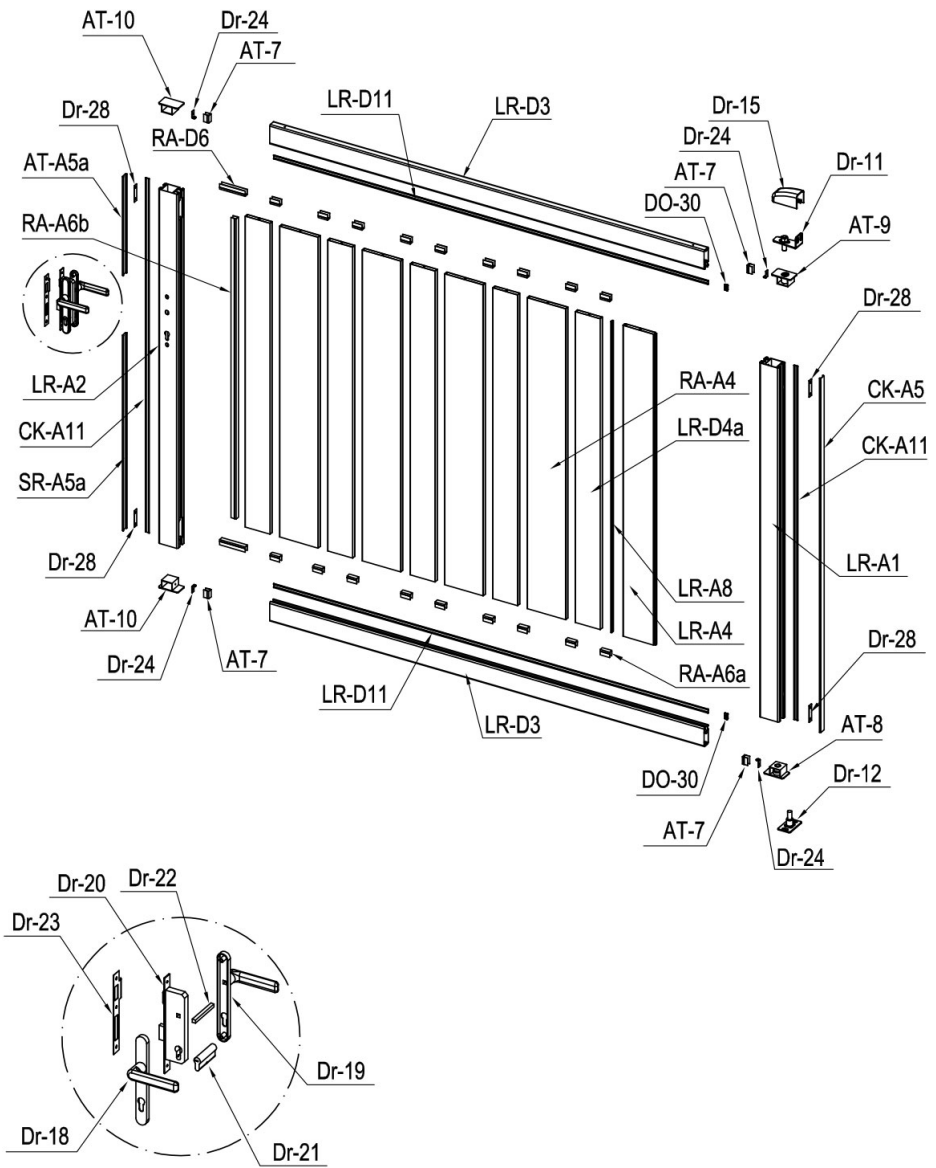

































INSTRUCTION MANUAL / NOTICE DE MONTAGE / MONTAGEANLEITUNG / MANUAL DE MONTAJE / MANUAL DE MONTAGEM / MANUALE DI MONTAGGIO /  
MONTAGEHANDLEIDING / INSTRUKCJA MONTAŻU / KÄYTTÖOHJEET / BRUKSANVISNING / BRUGSANVISNING / INSTRUCIUNI DE ASAMBLARE /  
NAVODILA ZA SESTAVLJANJE / NÁVOD NA MONTÁŽ / ÖSSZESZERELÉSI ÚTMUTATÓ / NÁVOD K MONTÁŽI / UPUTE ZA INSTALACIJU /  
ΟΔΗΓΙΕΣ ΣΥΝΑΡΜΟΛΟΓΗΣΗΣ / SURINKIMO INSTRUKCIJOS / MONTĀŽAS INSTRUKCIJAS











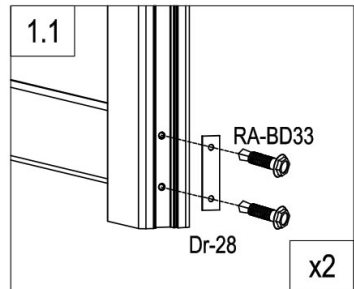
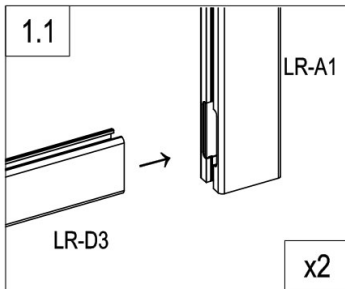
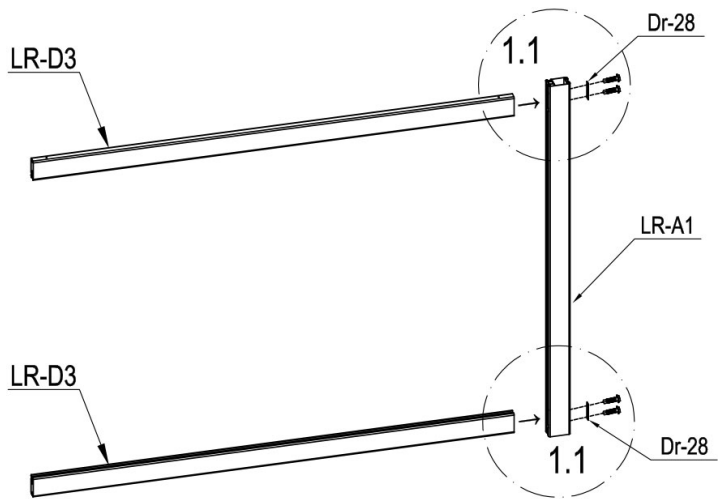

## PART LIST

IMAGE	NO.	L.(mm)	QTY	IMAGE	NO.	L.(mm)	QTY
	LR-A1	1418	2		Dr-14		1
	LR-A1a	1418	1		Dr-15		2
	LR-A2	1418	1		Dr-16		1
	LR-D3	1742	4		Dr-17		2
	LR-A4	1245	2		Dr-31		4
	RA-A4	1245	8		DO-30		4
	LR-D4a	1245	10		Dr-18		1
	CK-A5	1418	2		Dr-19		1
	AT-A5a	395.5	1		Dr-20		1
	SR-A5a	782	1		Dr-21		1
	Dr-A5c	19.5	1		Dr-22		1
	CK-A11	1418	4		Dr-23		1
	LR-D11	1742	4		Dr-25	M5x45	1
	AT-7	29.5	8		Dr-25a	M5x60	2
	RA-A6a	38	36		Dr-26	ST4x12	3
	RA-A6b	1202	2		Dr-27	ST4.2x25	2
	RA-D6	102	4		Dr-24		8
	LR-A8	1245	4		Dr-28		8
	CK-A7	1398	1		RA-BD30	ST4x10	8
	AT-8		2		RA-BD31	ST4.2x13	64
	AT-9		2		RA-BD32	M8x60	12
	AT-10		4		RA-BD33	ST5.5x38	16
	Dr-11		2		RA-BD34	ST6x40	3
	Dr-12		2		RA-BD35	Ø6	3
	Dr-13		1		RA-BD36	ST4.8x38	8



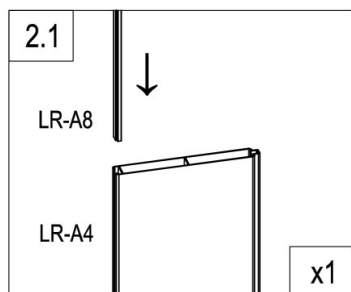
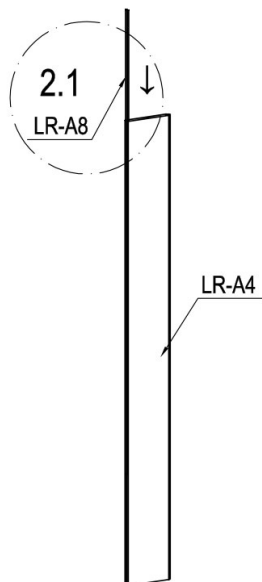

	LR-A1	1
	LR-D3	2
	Dr-28	2
	RA-BD33	4

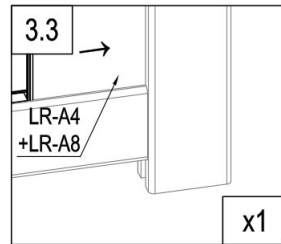
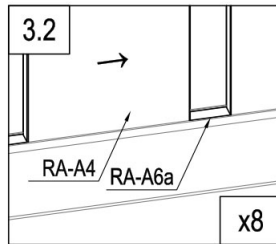
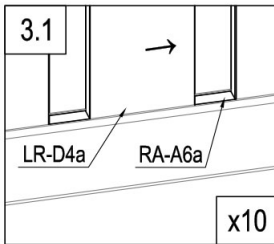
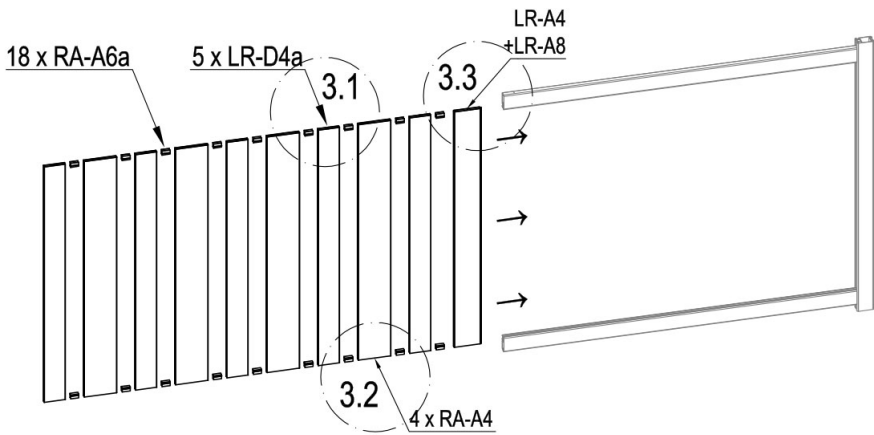

	LR-A8	1
	LR-A4	1



	RA-A4	4
	LR-D4a	5
	RA-A6a	18

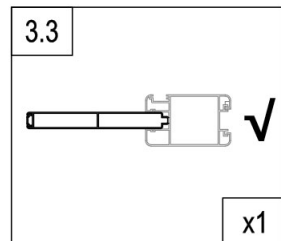



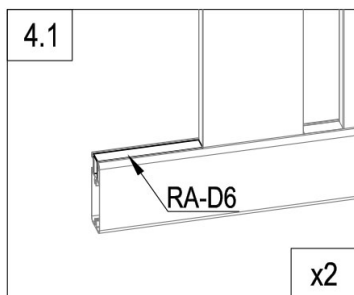
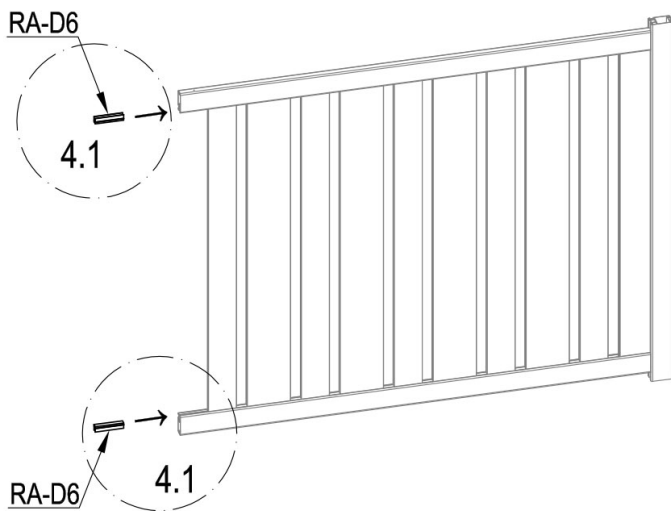



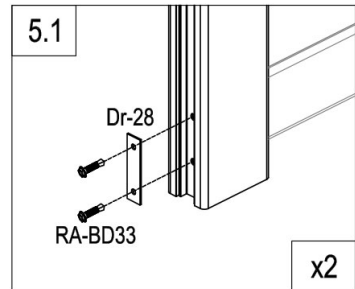
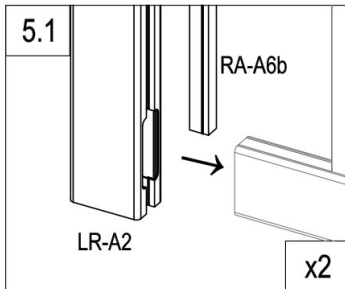
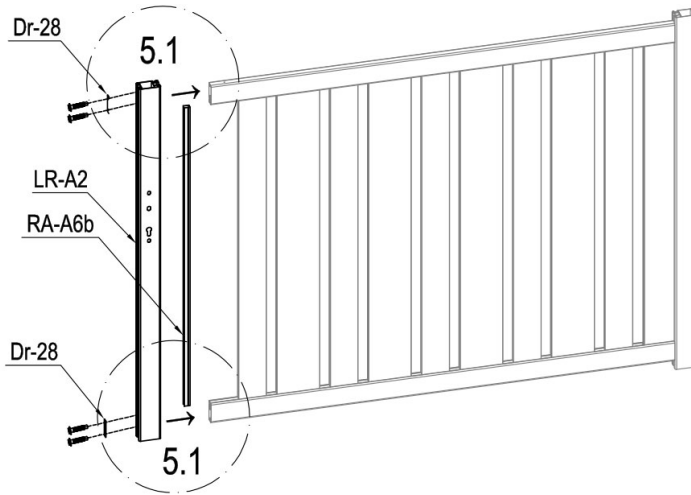

	RA-D6	2
---	-------	---



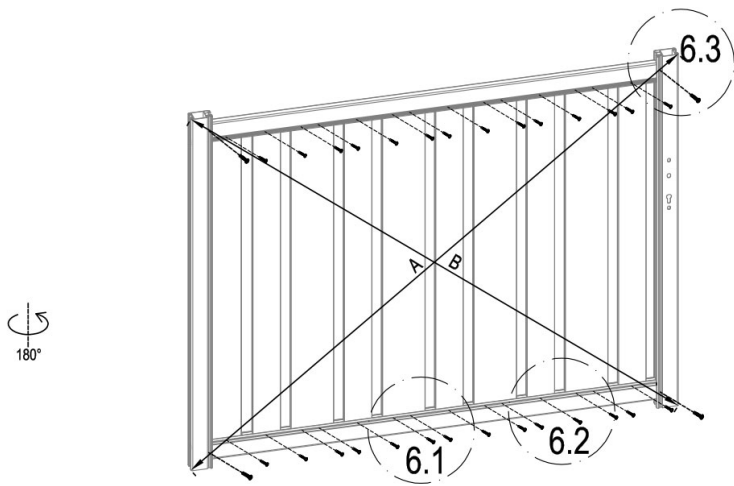

	LR-A2	1
	RA-A6b	1
	Dr-28	2
	RA-BD33	4

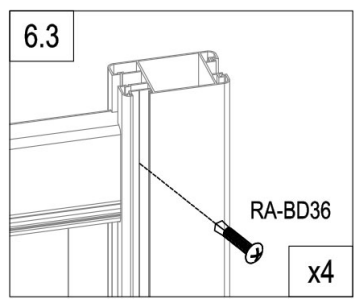
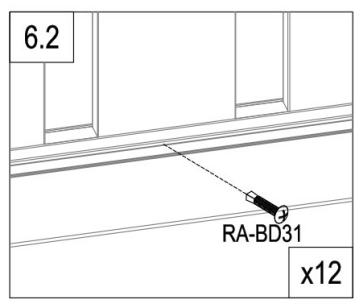
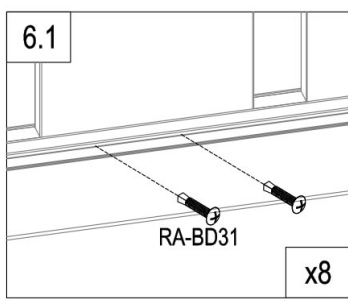

A=B



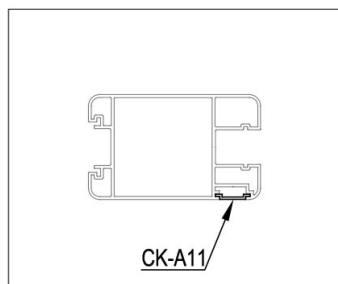
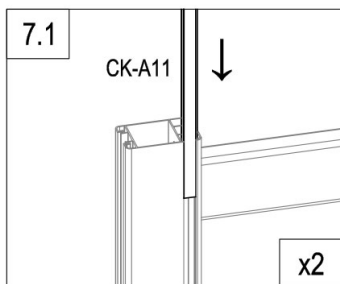
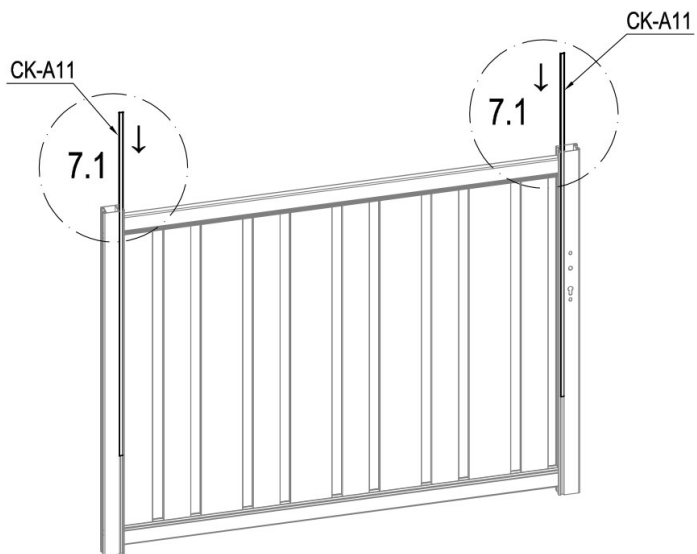

	RA-BD31	28
	RA-BD36	4

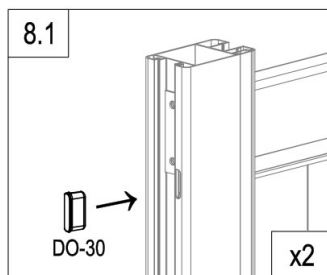
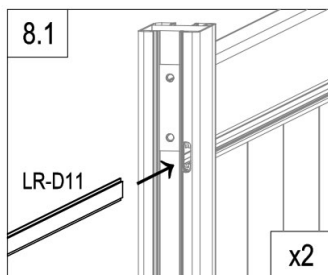
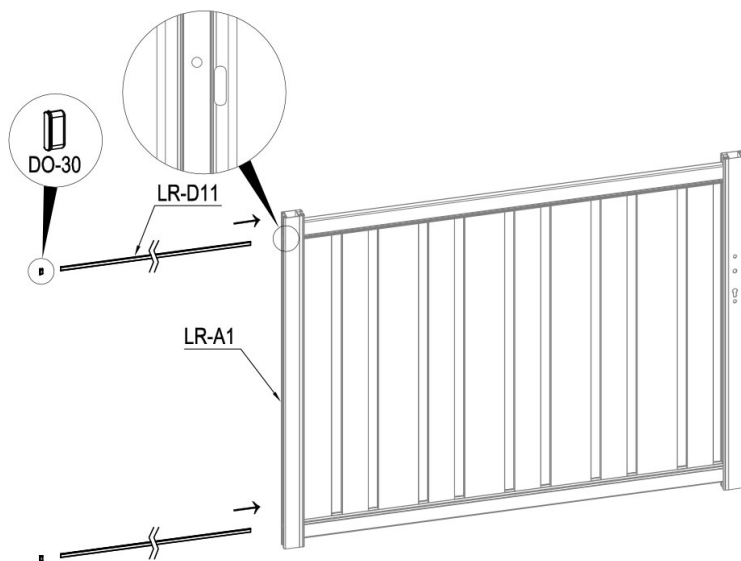

	CK-A11	2
---	--------	---



	LR-D11	2
	DO-30	2

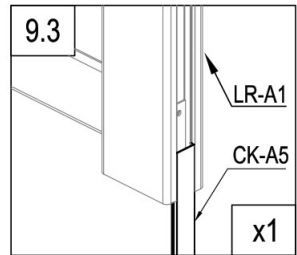
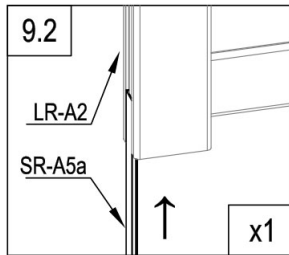
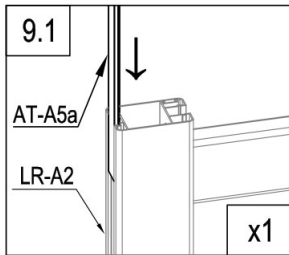
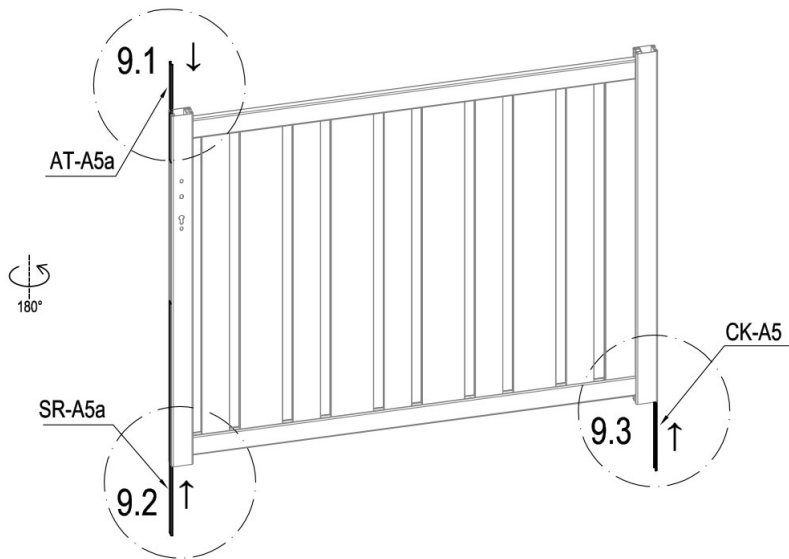

	CK-A5	1
	AT-A5a	1
	SR-A5a	1

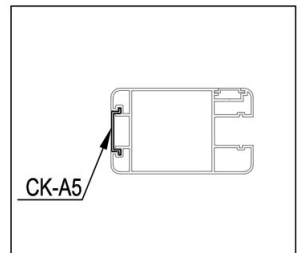

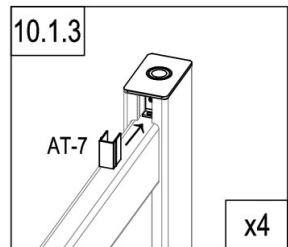
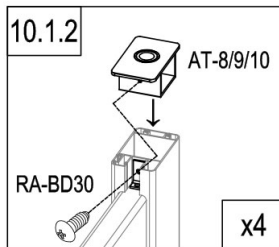
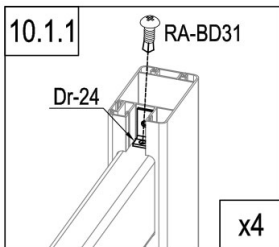
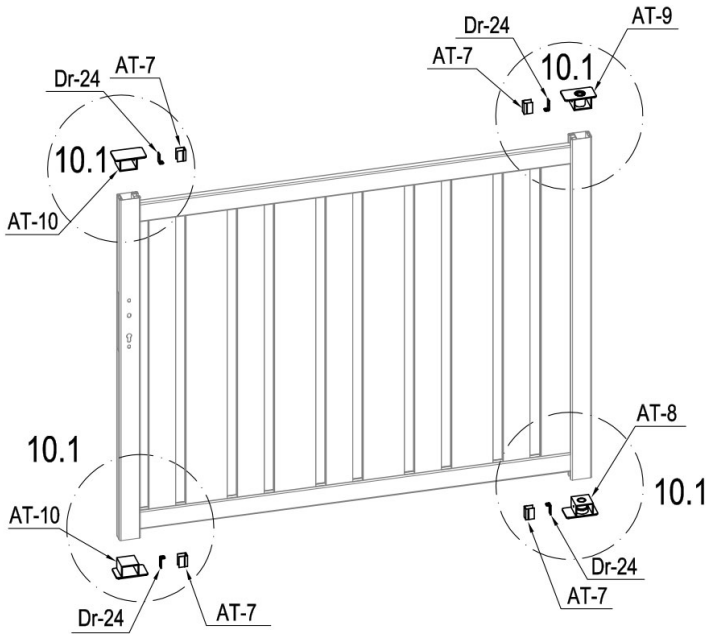





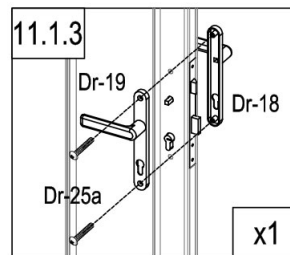
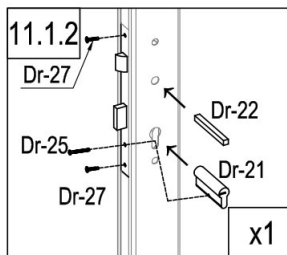
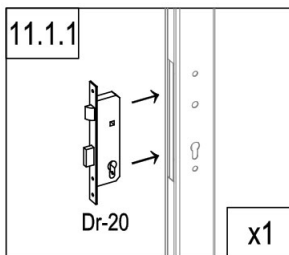
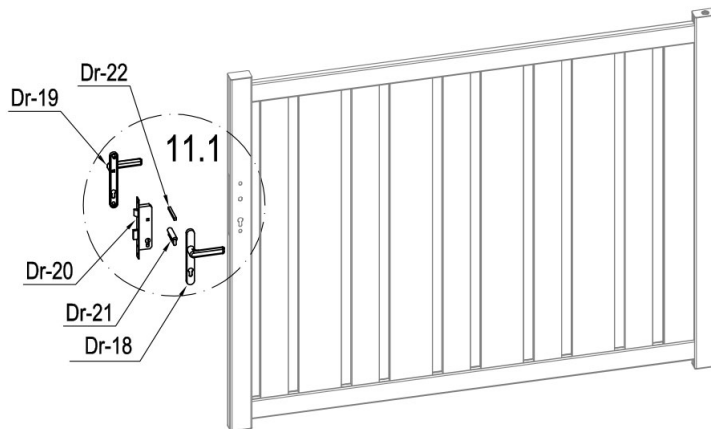



	AT-8	1
	AT-9	1
	AT-10	2
	Dr-24	4

	AT-7	4
	RA-BD30	4
	RA-BD31	4







	Dr-20	1
	Dr-21	1
	Dr-22	1
	Dr-25	1

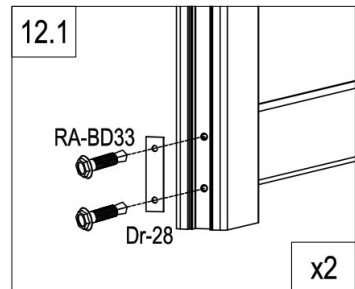
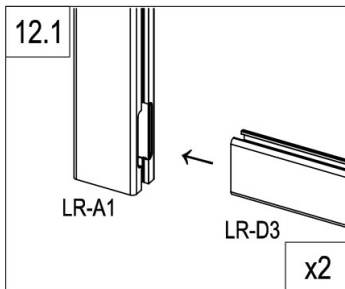
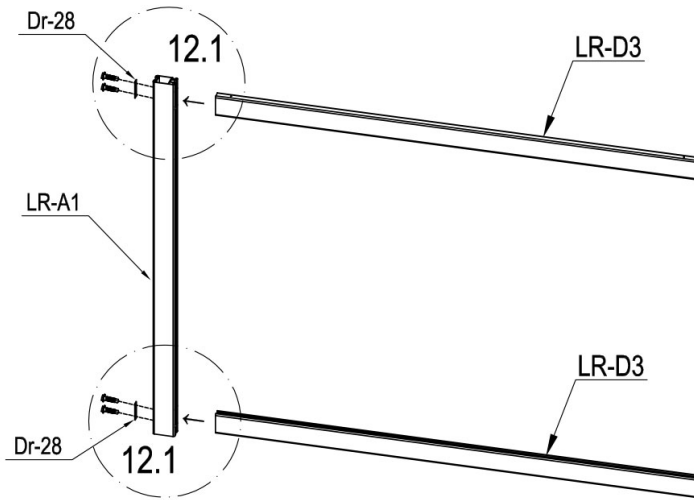

	Dr-18	1
	Dr-19	1
	Dr-25a	2
	Dr-27	2





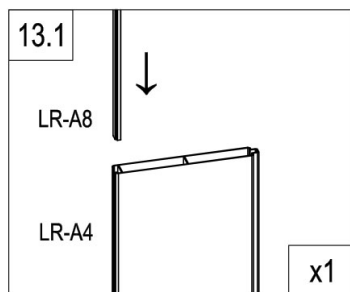
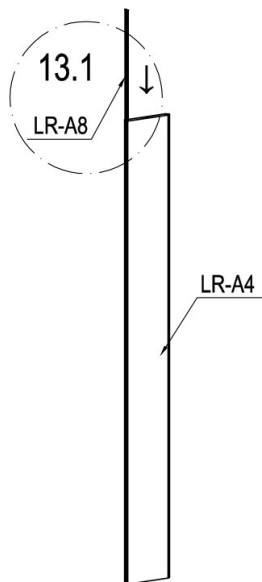



	LR-A1	1
	LR-D3	2
	Dr-28	2
	RA-BD33	4

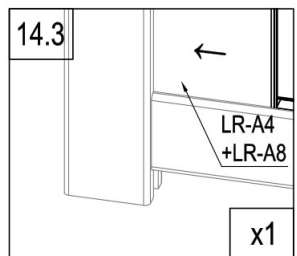
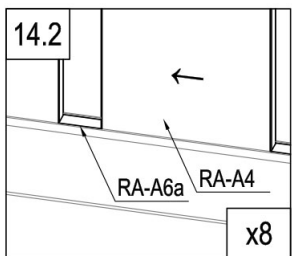
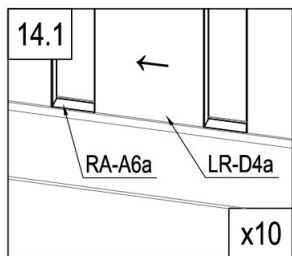
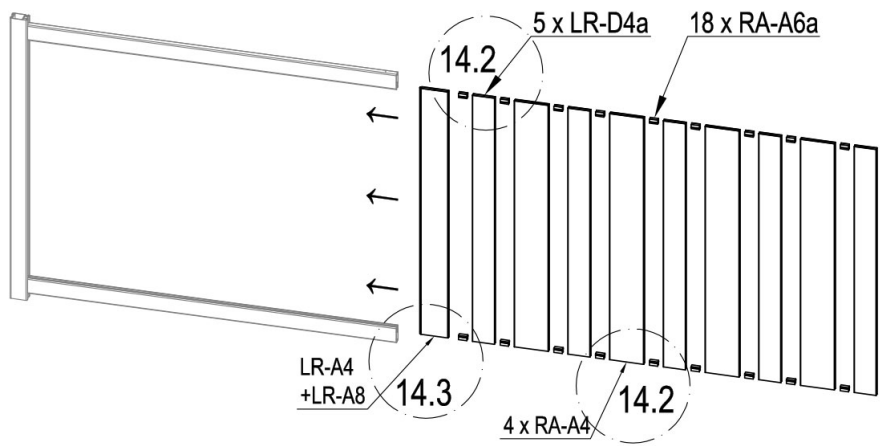

	LR-A8	1
	LR-A4	1

# CASANOVO





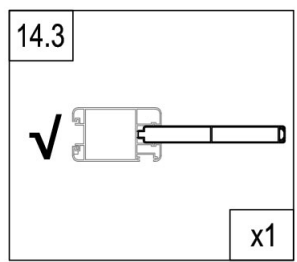

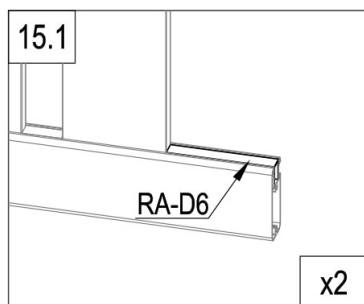
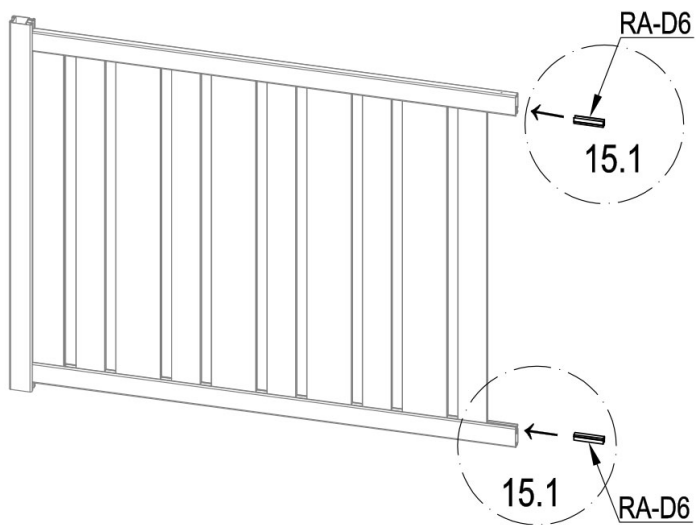
	RA-A4	4
	LR-D4a	5
	RA-A6a	18



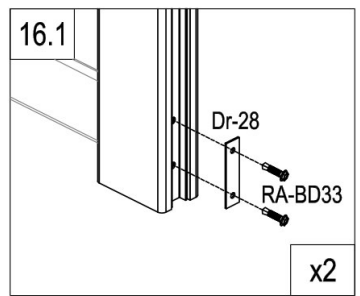
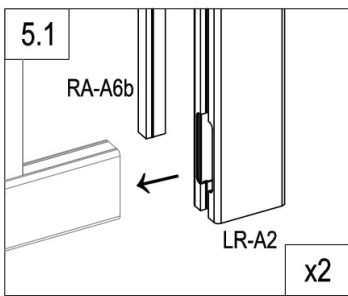
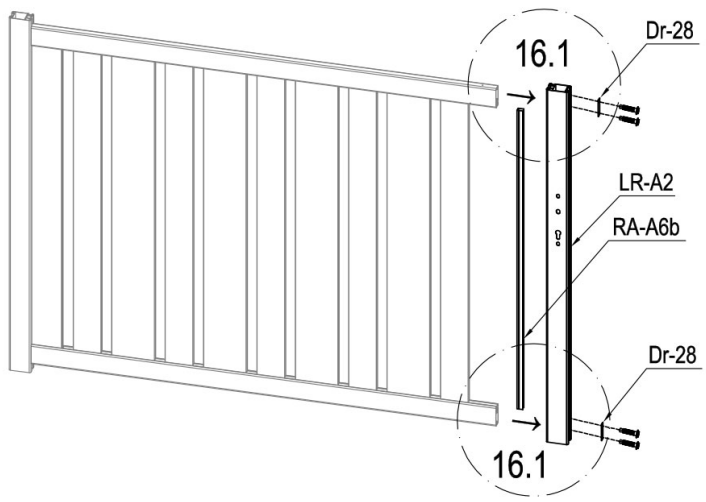

	RA-D6	2
---	-------	---



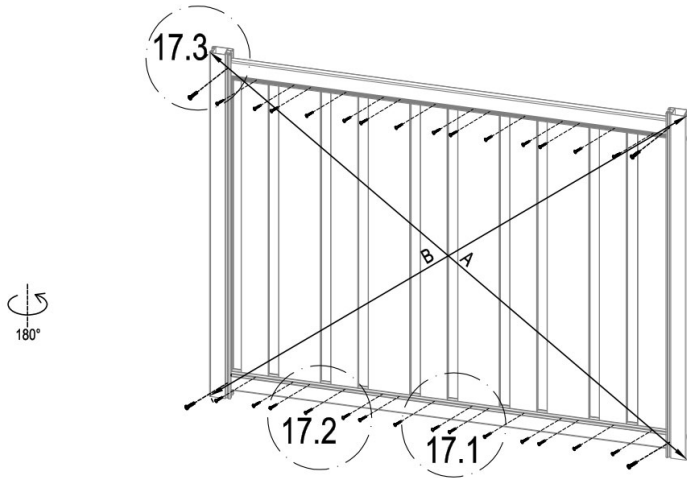

	LR-A2	1
	RA-A6b	1
	Dr-28	2
	RA-BD33	4

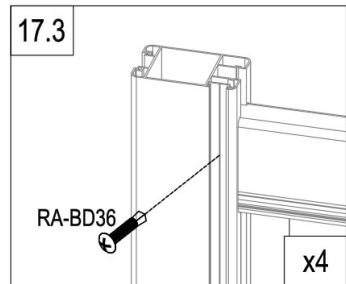
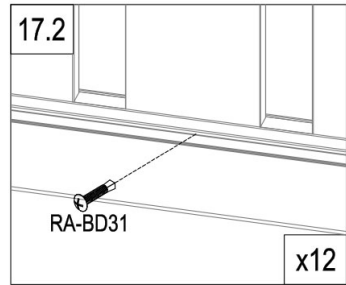
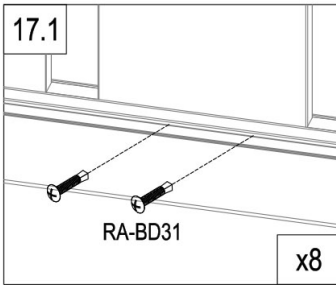

A=B



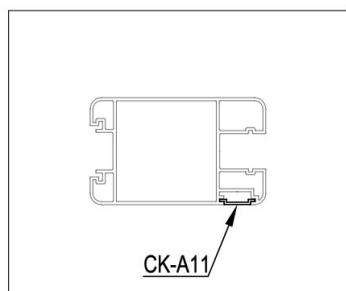
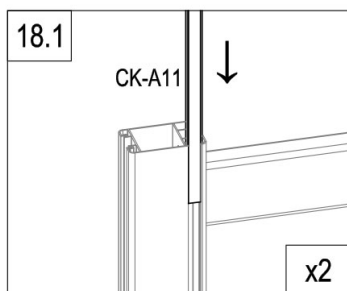
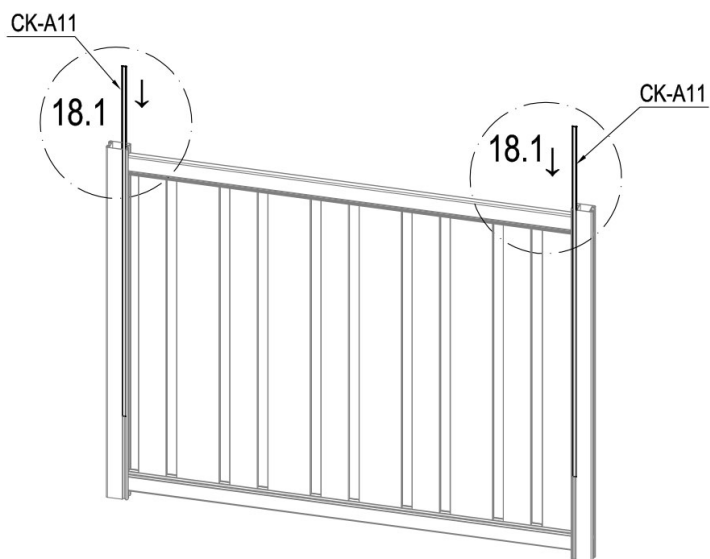

	RA-BD31	28
	RA-BD36	4



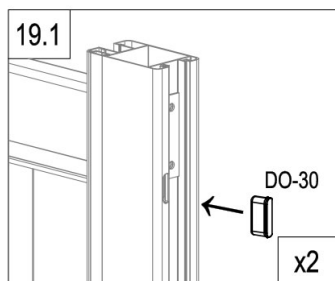
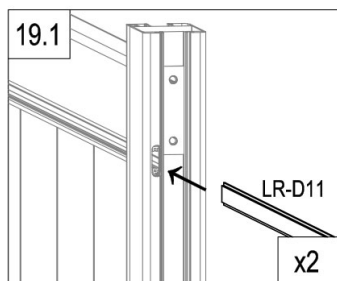
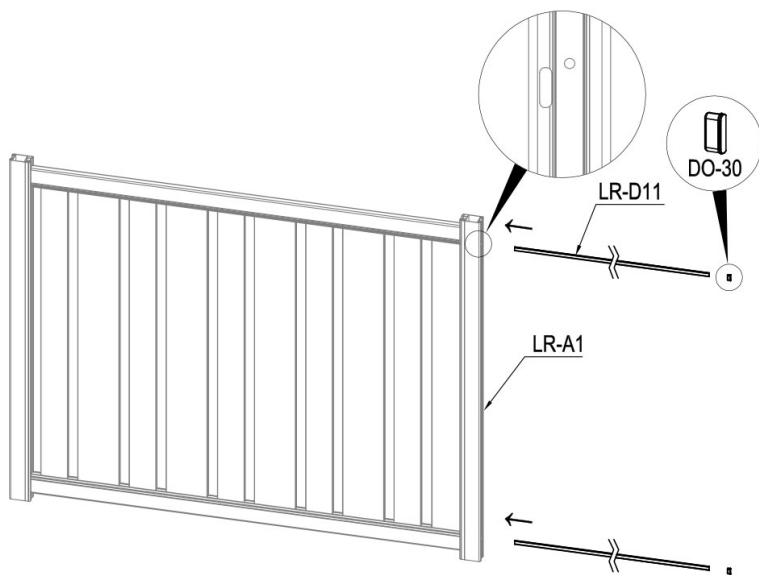

	CK-A11	2
---	--------	---



	LR-D11	2
	DO-30	2

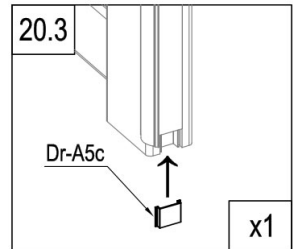
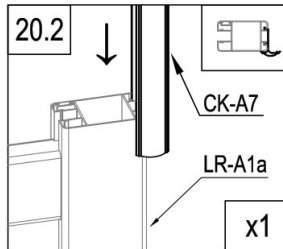
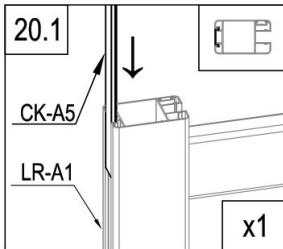
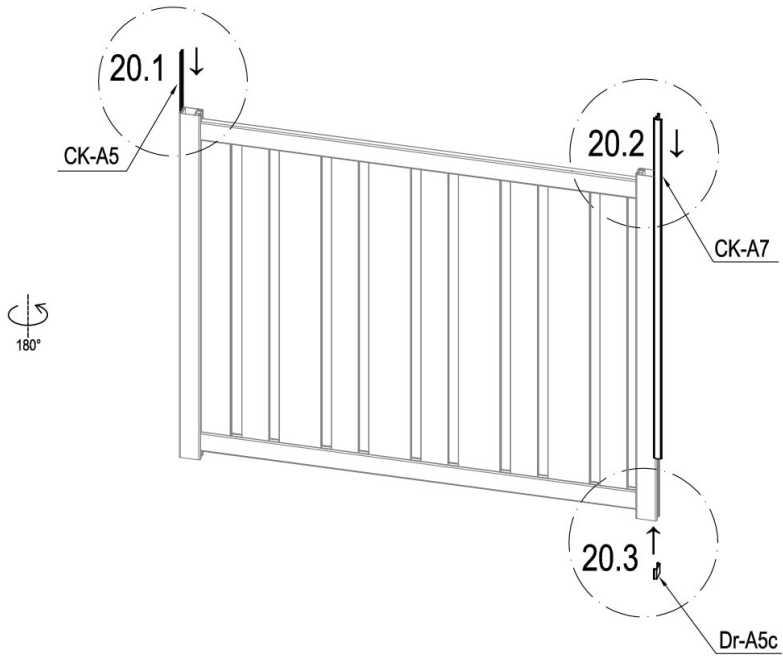



	CK-A5	1
	Dr-A5c	1
	CK-A7	1

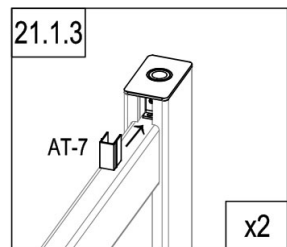
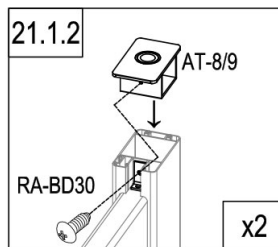
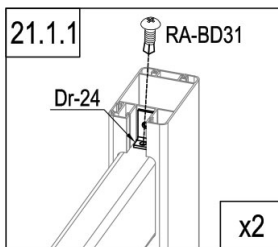
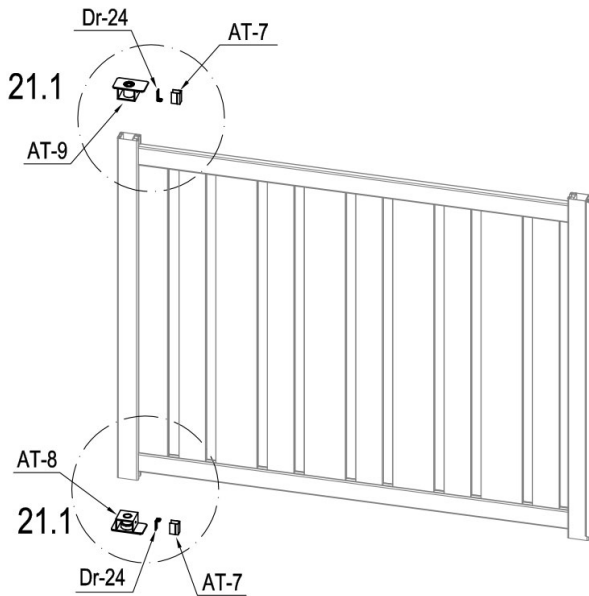

	AT-8	1
	AT-9	1
	Dr-24	2

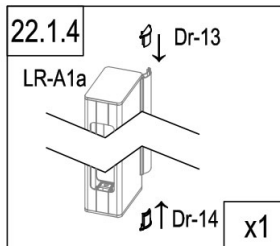
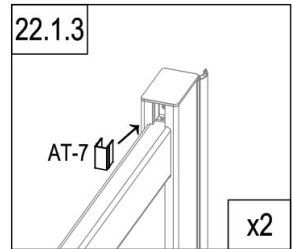
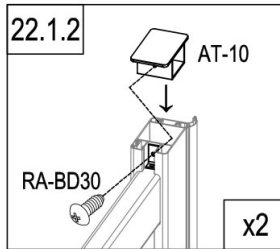
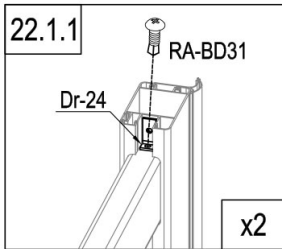
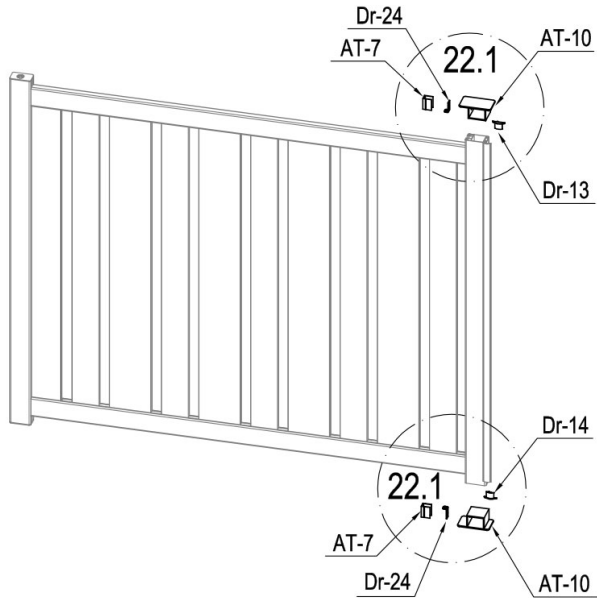

	AT-7	2
	RA-BD30	2
	RA-BD31	2



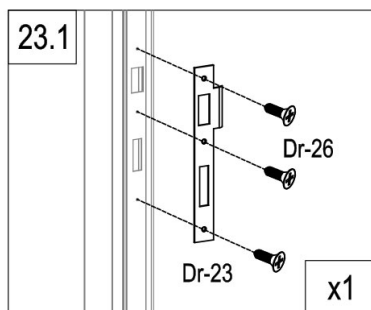
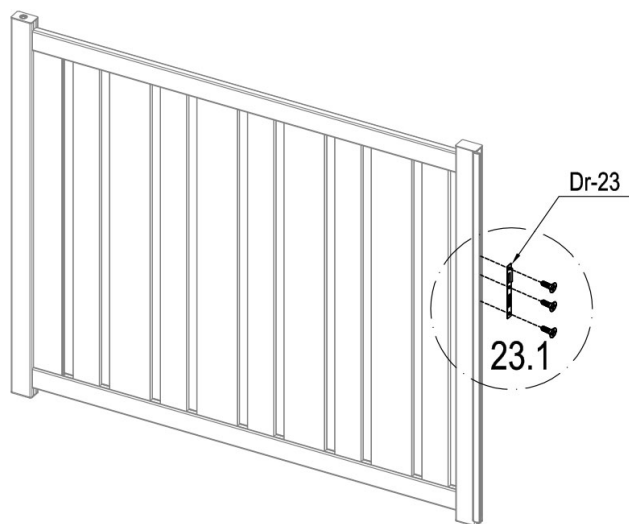

	AT-10	2
	Dr-24	2
	AT-7	2
	Dr-13	1

	Dr-14	1
	RA-BD30	2
	RA-BD31	2



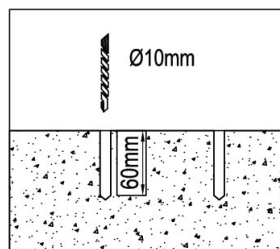
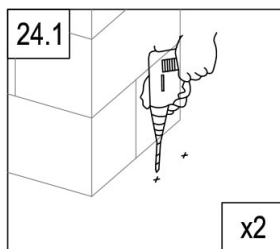
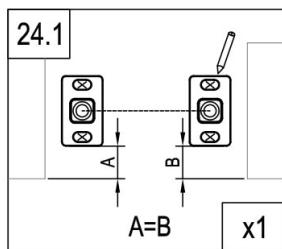
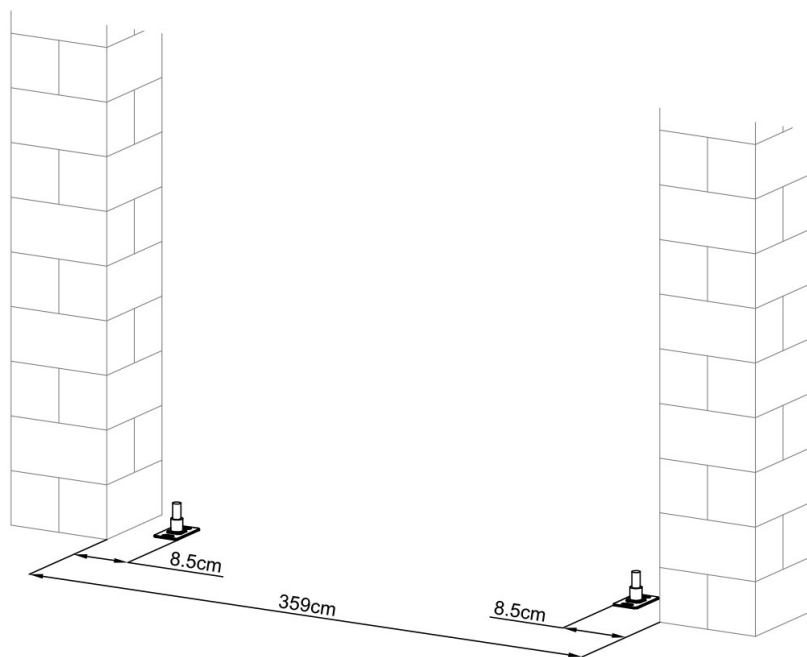

	Dr-23	1
	Dr-26	3



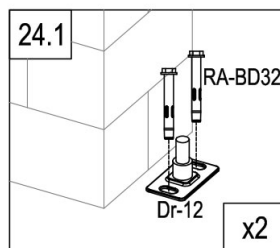

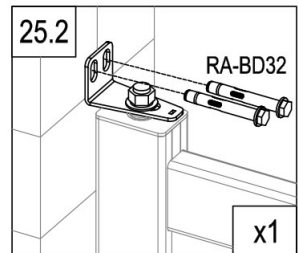
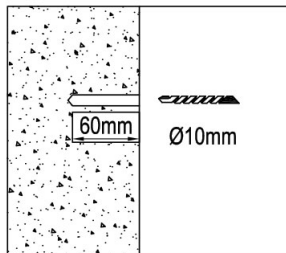
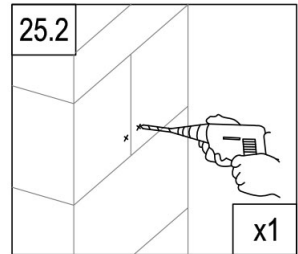
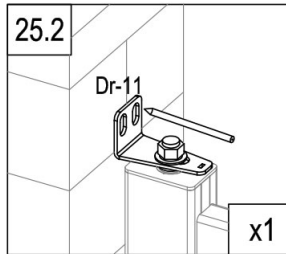
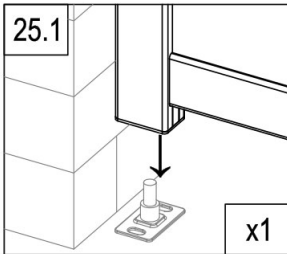
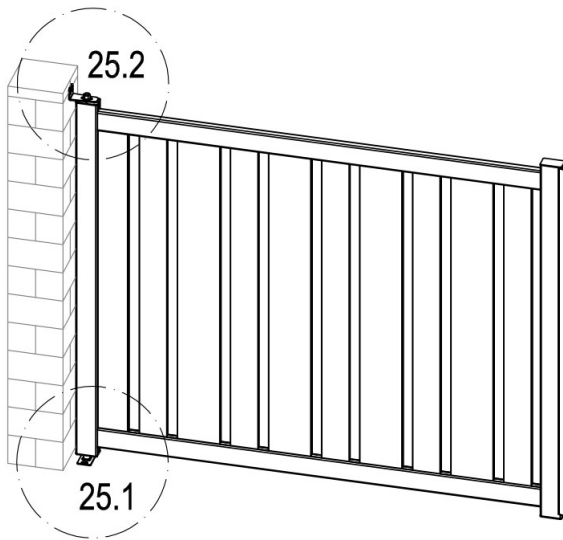
	Dr-12	2
	RA-BD32	4



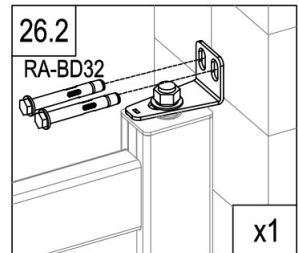
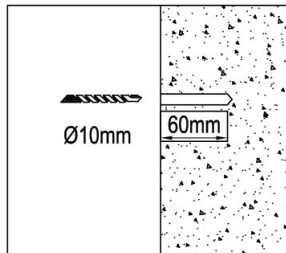
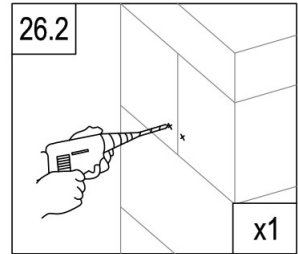
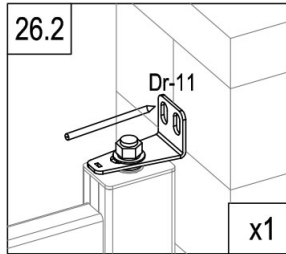
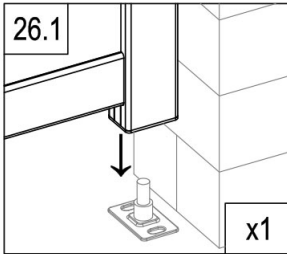
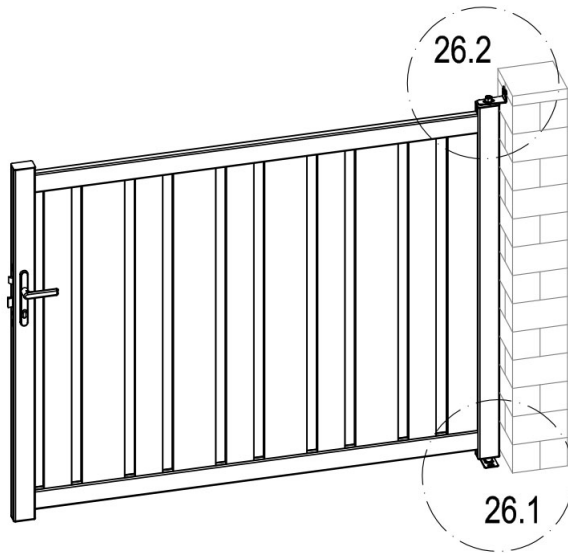

	Dr-11	1
	RA-BD32	2



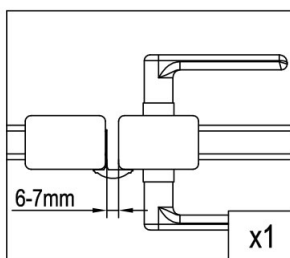
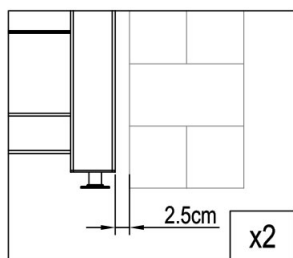
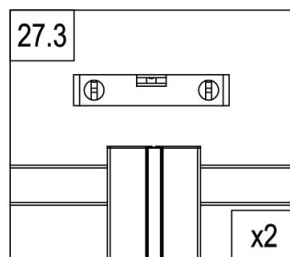
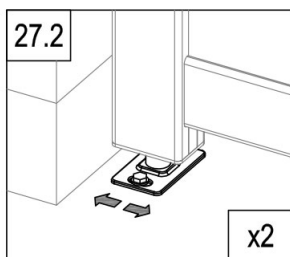
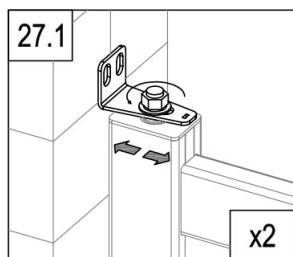
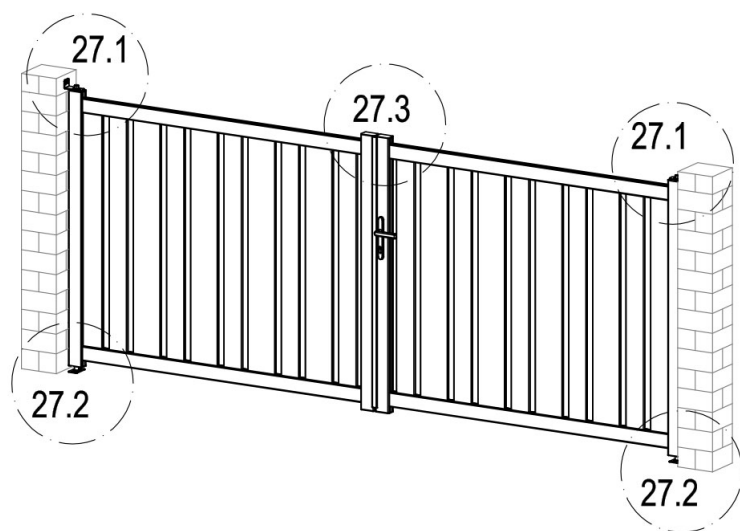

	Dr-11	1
	RA-BD32	2



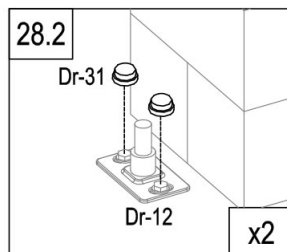
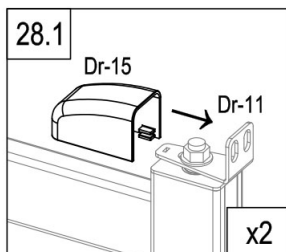
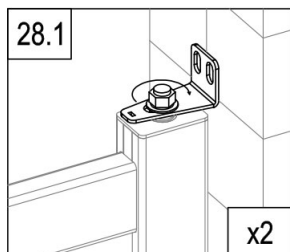
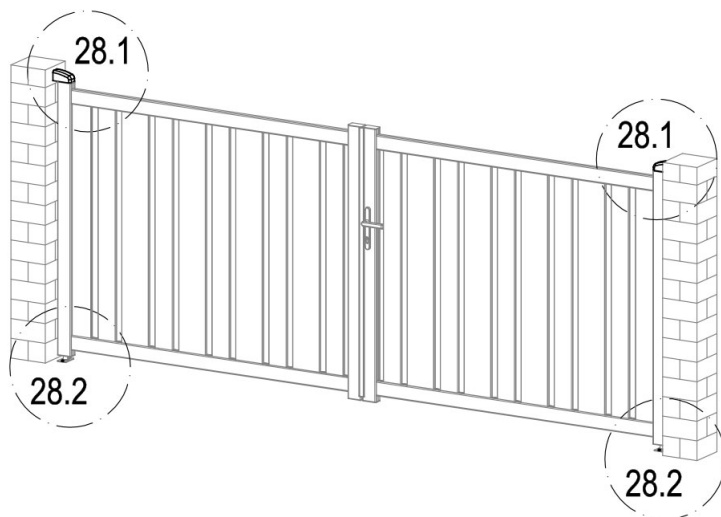





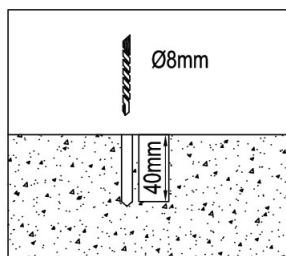
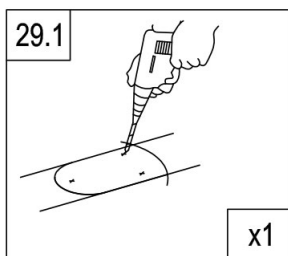
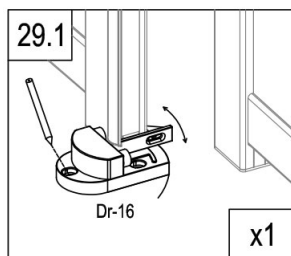
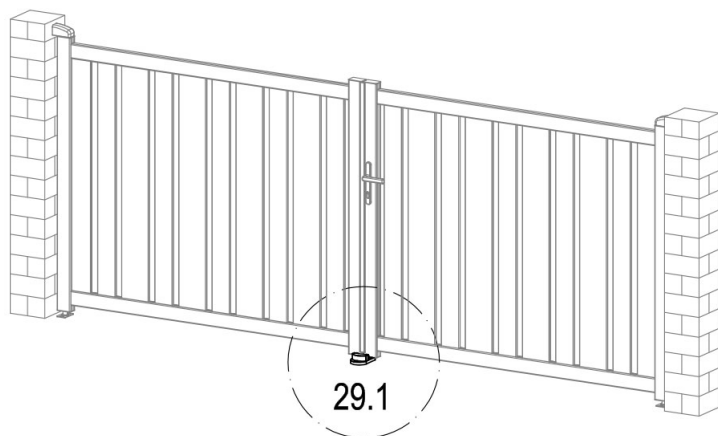

	Dr-15	2
	Dr-31	4

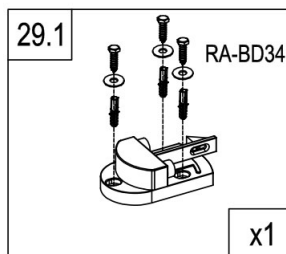

	Dr-16	1
	RA-BD34	3
	RA-BD35	3

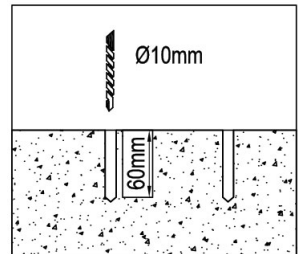
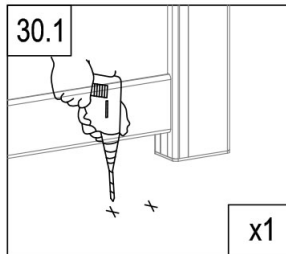
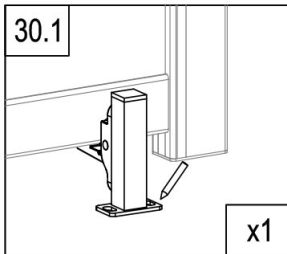
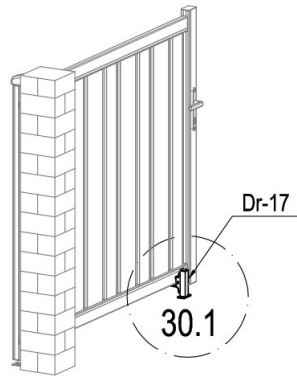
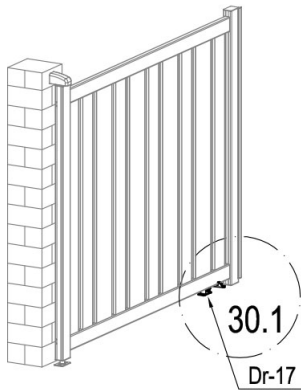



	RA-BD32	4
	Dr-17	2

