

CASANOVO

OLGA 300B100

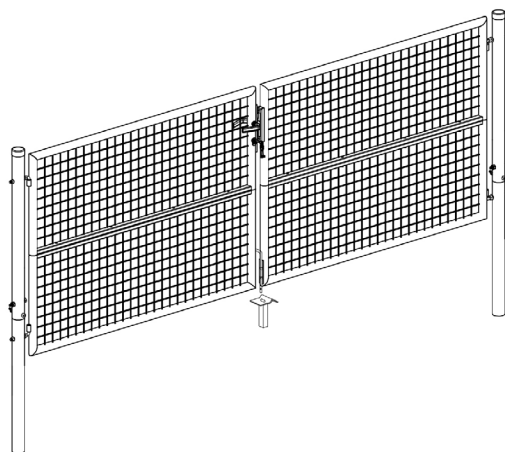

COM-000524 [x1]

COM-000525 [x1]

COM-000526 [x1]



2 H



X 2

EN FR DE ES PT IT NL PL FI SE DK







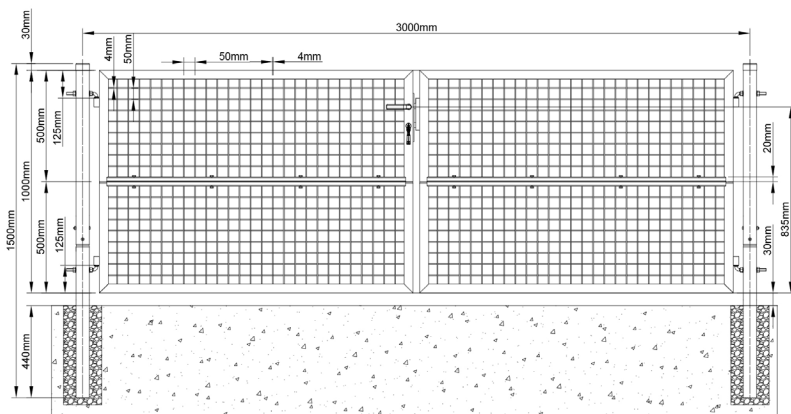

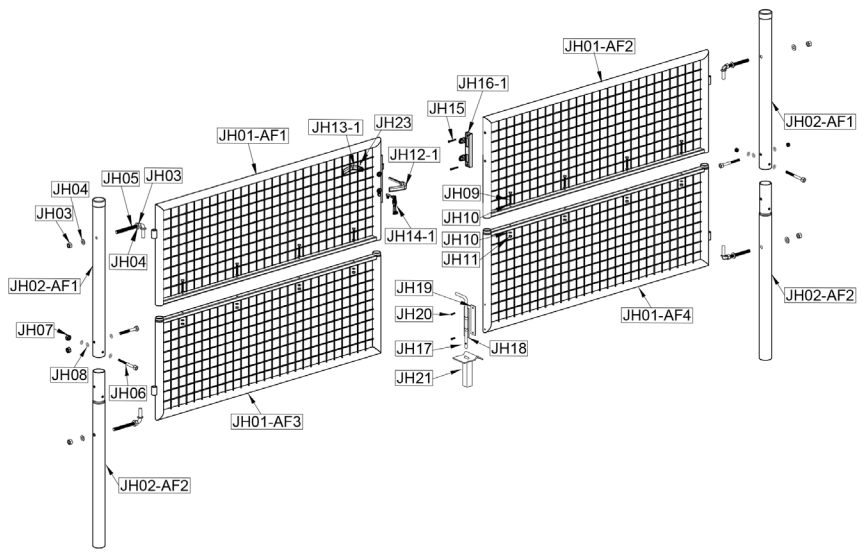

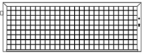
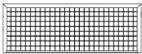
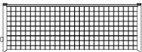
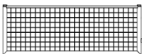











RO SI SK HU CZ HR GR LT LV







INSTRUCTION MANUAL / NOTICE DE MONTAGE / MONTAGEANLEITUNG / MANUAL DE MONTAJE / MANUAL DE MONTAGEM / MANUALE DI MONTAGGIO /
MONTAGEHANDLEIDING / INSTRUKCJA MONTAŻU / KÄYTTÖOHJEET / BRUKSANVISNING / BRUGSANVISNING / INSTRUCȚIUNI DE ASAMBLARE /
NAVODILA ZA SESTAVLJANJE / NÁVOD NA MONTÁŽ / ÖSSZESZERELÉSI ÚTMUTATÓ / NÁVOD K MONTÁŽI / UPUTE ZA INSTALACIJU /
ΟΔΗΓΙΕΣ ΣΥΝΑΡΜΟΛΟΓΗΣΗΣ / SURINKIMO INSTRUKCIJOS / MONTĀŽAS INSTRUKCIJAS



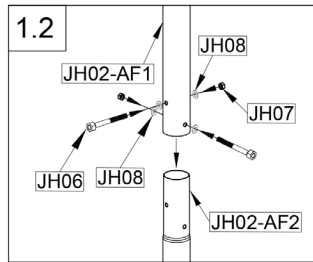
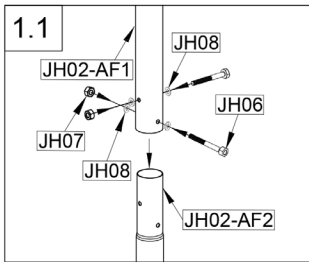
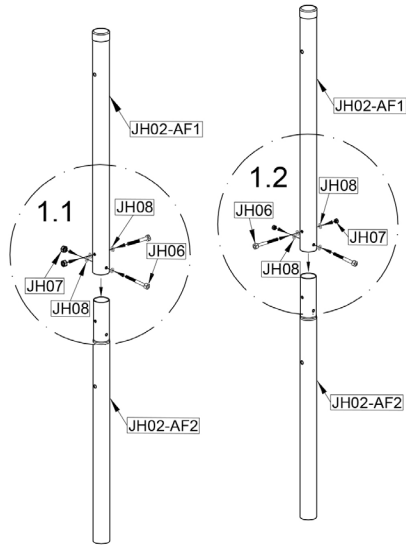





PICTURES	REF-PCS	SIZE	QUANTITY
	JH01-AF1	1410×500mm	1
	JH01-AF2	1410×500mm	1
	JH01-AF3	1410×500mm	1
	JH01-AF4	1410×500mm	1
	JH02-AF1	φ60×825mm	2
	JH02-AF2	φ60×825mm	2
	JH03	20×10mm	8
	JH04	24×1mm	8
	JH05	12×120mm	4
	JH06	10×70mm	4
	JH07	20×7mm	4
	JH08	20×1mm	8
	JH09	8×55mm	8
	JH10	17×1mm	16
	JH11	15×5mm	8
	JH12-1	16×95×110mm	1
	JH13-1	16×34×110mm	1
	JH14-1	6×70mm	3
	JH15	6×35mm	2
	JH16-1	30×173mm	1
	JH17	12×245mm	1
	JH18	23×140mm	1
	JH19	23×140mm	1
	JH20	6×20mm	2
	JH21	60×95×145mm	1
	JH23	2×19mm	1

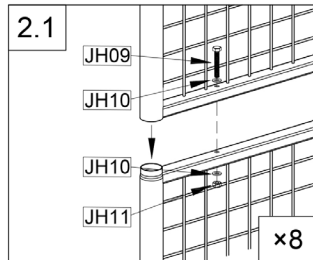
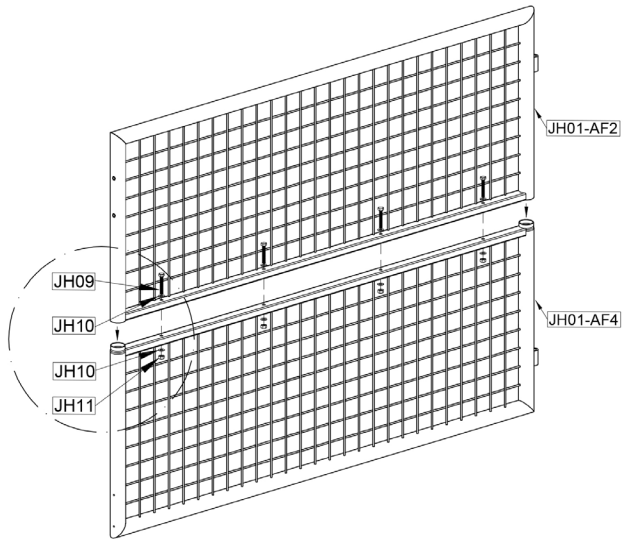





Thumbnails	No.	Size	Quantity
	JH06	10×70mm	4
	JH07	20×7mm	4
	JH08	20×1mm	8

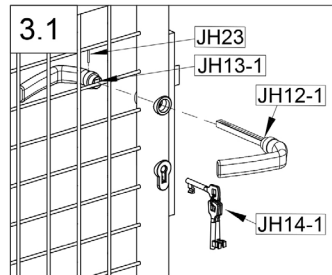
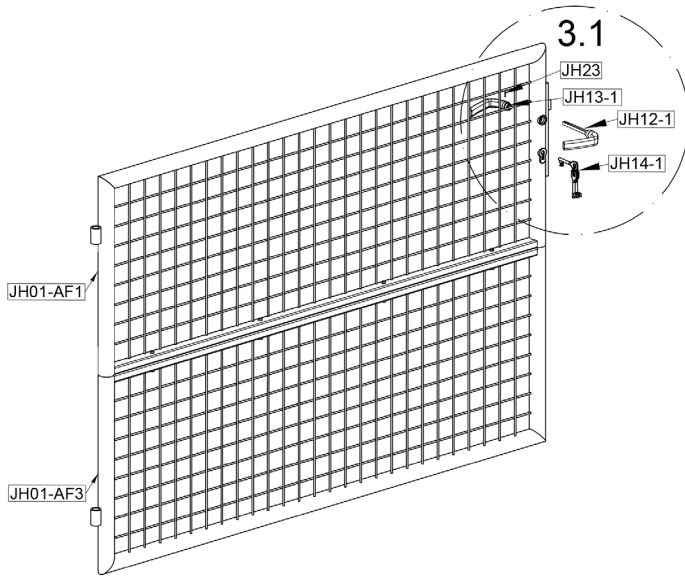

Thumbnails	No.	Size	Quantity
	JH09	8×55mm	8
	JH10	17×1mm	16
	JH11	15×5mm	8



Thumbnails	No.	Size	Quantity
	JH12-1	16×95×110mm	1
	JH13-1	16×34×110mm	1
	JH14-1	6×70mm	3
	JH23	2×19mm	1

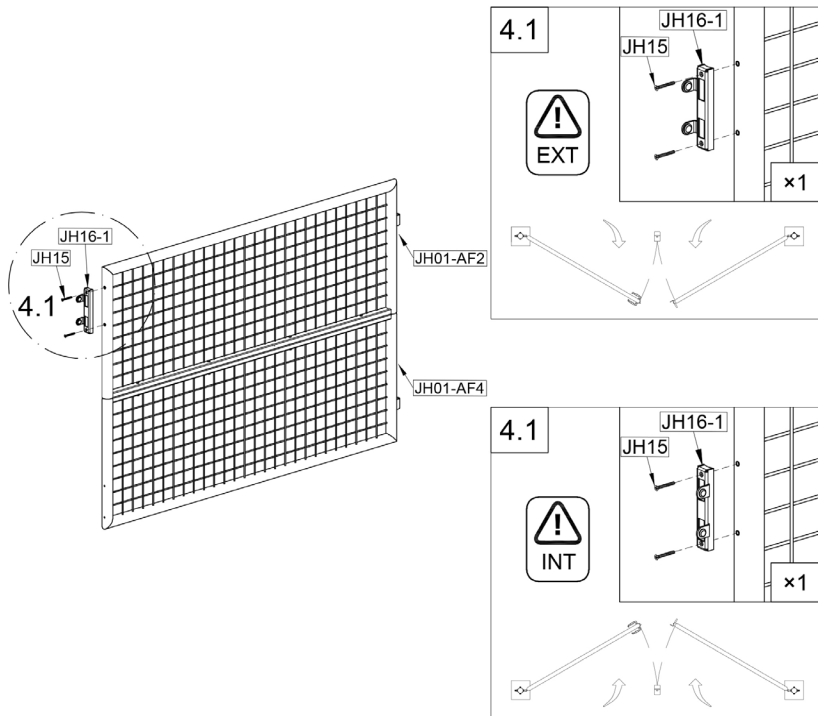

Thumbnails	No.	Size	Quantity
-	JH15	6x35mm	2
	JH16-1	30x173mm	1

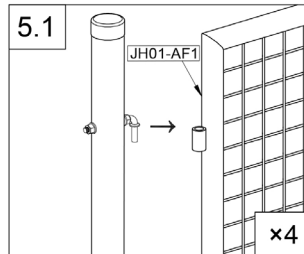
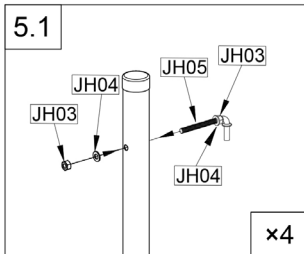
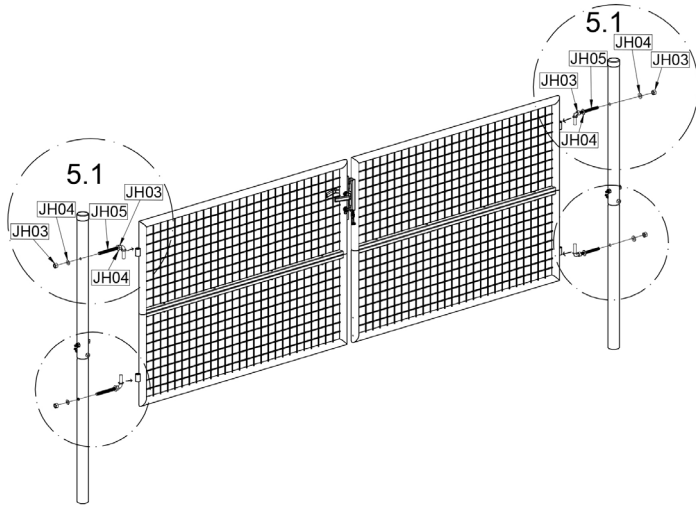

Thumbnails	No.	Size	Quantity
	JH03	20×10mm	8
	JH04	24×1mm	8
	JH05	12×120mm	4

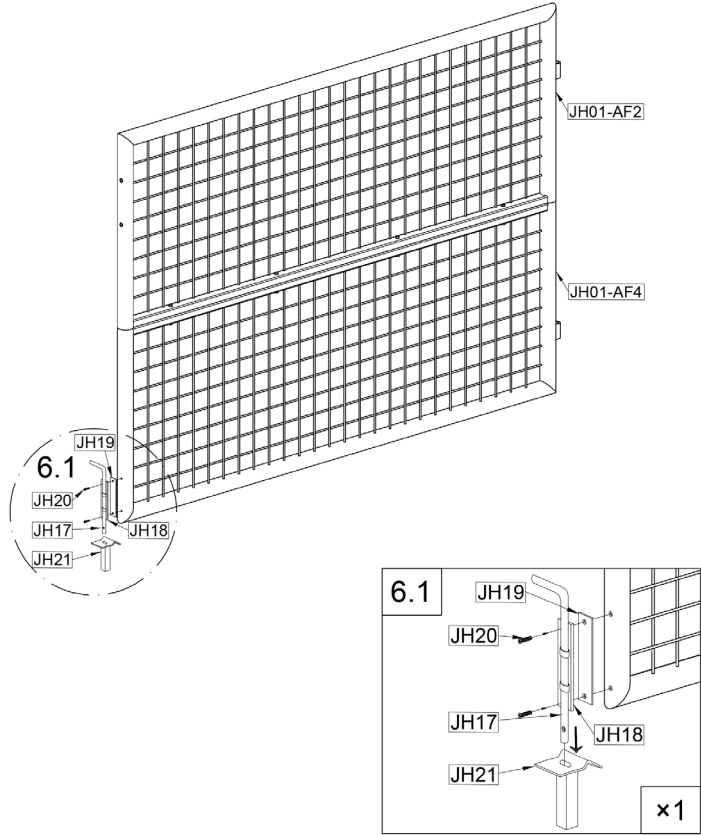

Thumbnails	No.	Size	Quantity
	JH17	12×245mm	1
	JH18	23×140mm	1
	JH19	23×140mm	1
	JH20	6×20mm	2
	JH21	60×95×145mm	1

