

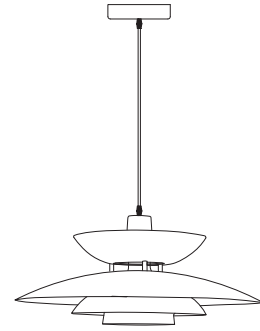

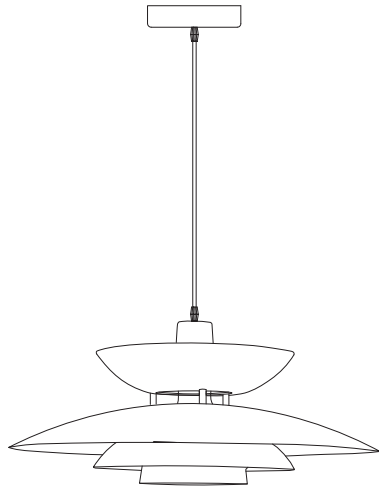

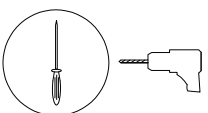

JURGA



 15'

 1

1/5

2616/JURGA/0906.25/



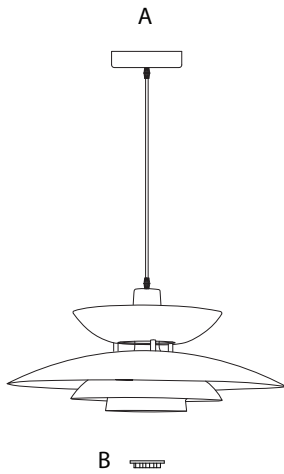



1

A x 1

1a

1b

OFF

<p>A</p>  <p>x 1</p>	<p>B</p>  <p>x 1</p>	<p>C</p>  <p>x 2</p>	<p>D</p>  <p>x 2</p>	<p>E</p>  <p>x 1</p>
--	---	---	---	---

2/5

2616/JURGA/0906.25/

2

C x 2

D x 2

1a

1b

A

3/5

2616/JURGA/0906.25/

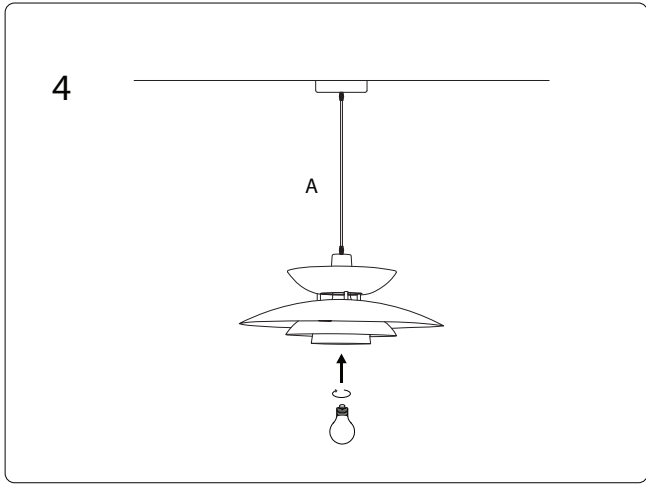
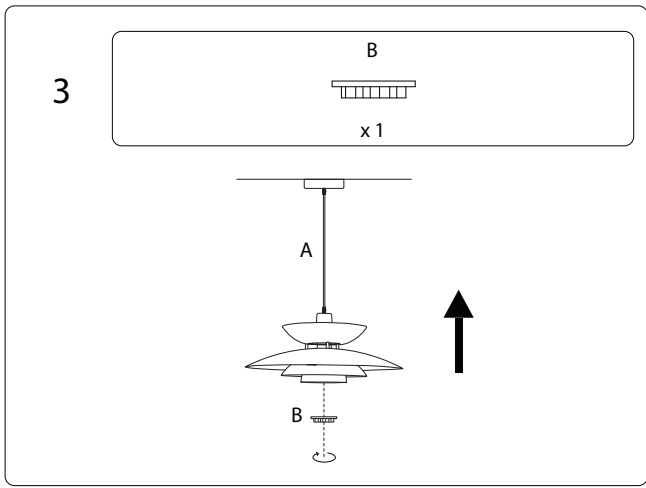

4/5

2616/JURGA/090625/

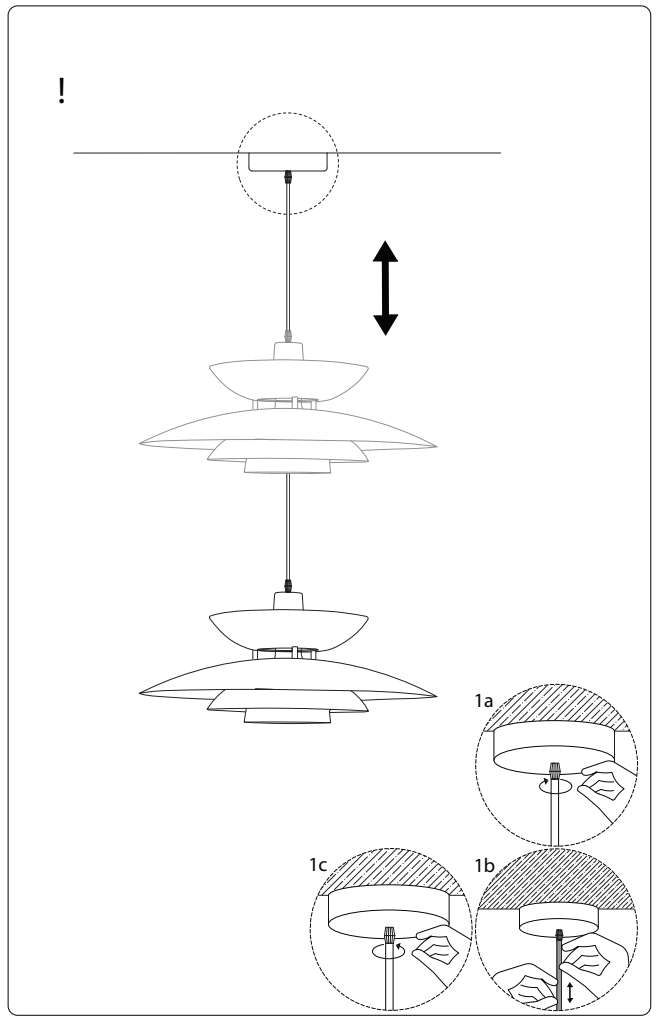

5/5

2616/JURGA/090625/