

# CASANOVO

## GIONA 350C160

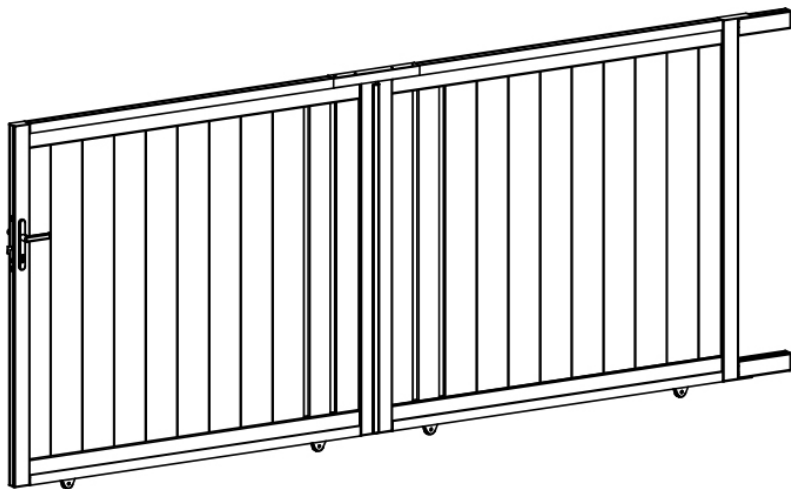

COM-000814 [x1]

COM-000816 [x1]

COM-000815 [x1]



7-8H



X 2



INSTRUCTION MANUAL / NOTICE DE MONTAGE / MONTAGEANLEITUNG / MANUAL DE MONTAJE / MANUAL DE MONTAGEM / MANUALE DI MONTAGGIO /  
MONTAGEHANDLEIDING / INSTRUKCJA MONTAŻU / KÄYTTÖOHJEET / BRUKSANVISNING / BRUGSANVISNING / INSTRUCȚIUNI DE ASAMBLARE /  
NAVODILA ZA SESTAVLJANJE / NÁVOD NA MONTÁŽ / ÖSSZESZERELÉSI ÚTMUTATÓ / NÁVOD K MONTÁŽI / UPUTE ZA INSTALACIJU /  
ΟΔΗΓΙΕΣ ΣΥΝΑΡΜΟΛΟΓΗΣΗΣ / SURINKIMO INSTRUKCIJOS / MONTÁŽAS INSTRUKCIJAS

**Ext.**

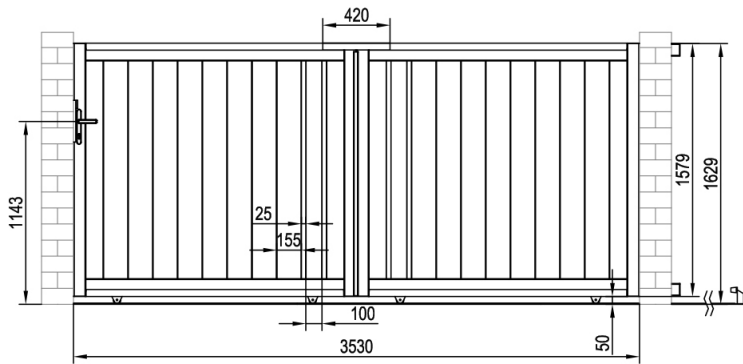

**Int.**

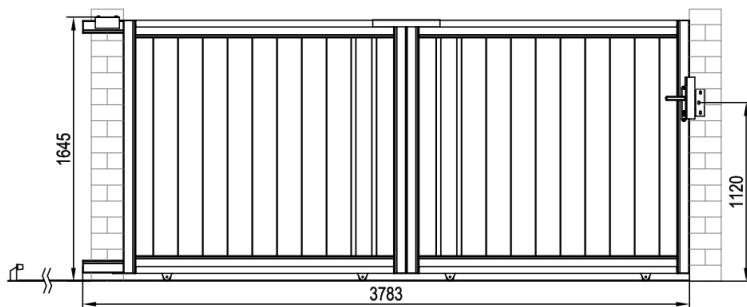



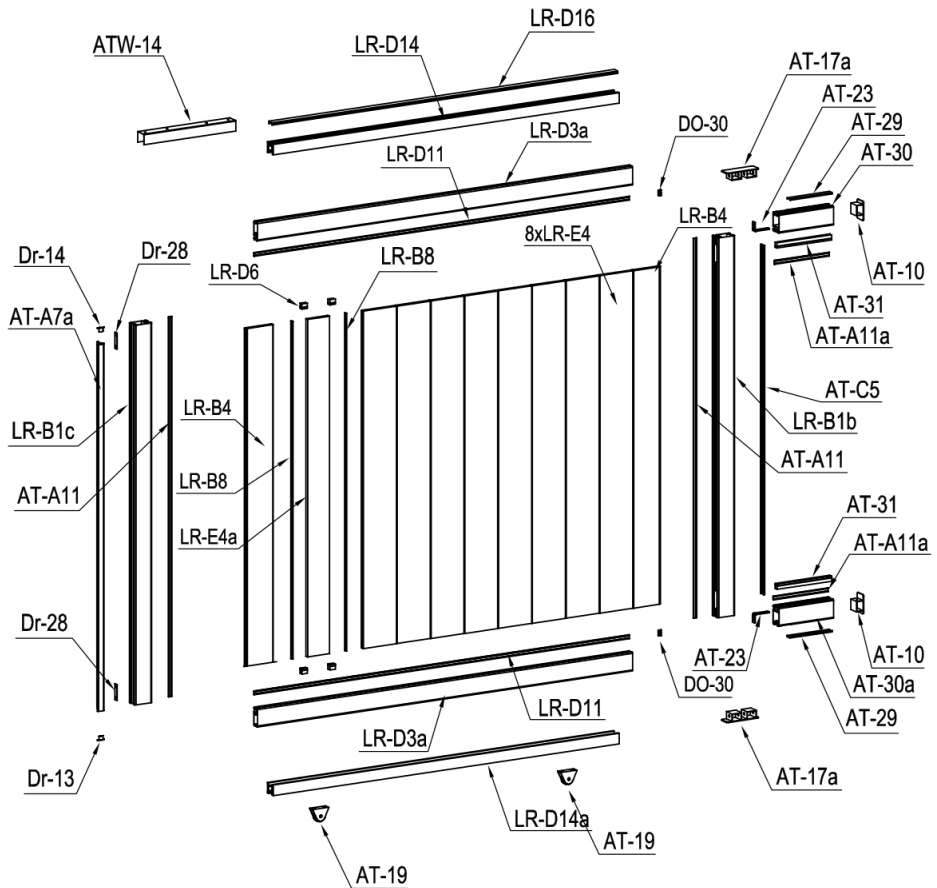

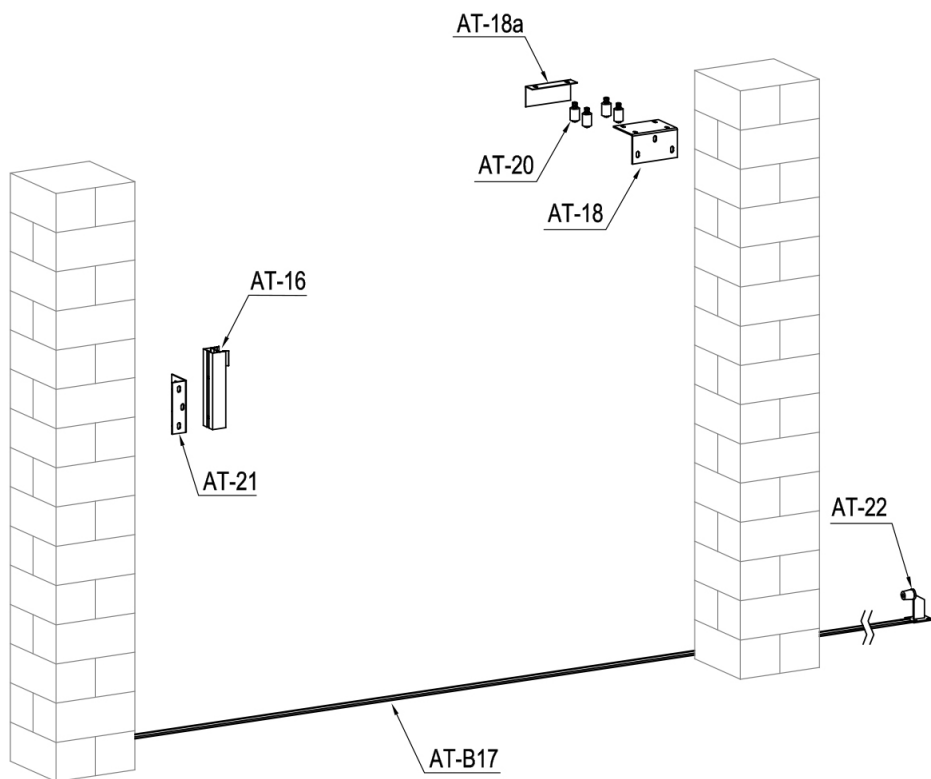















































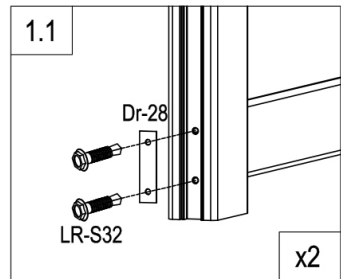
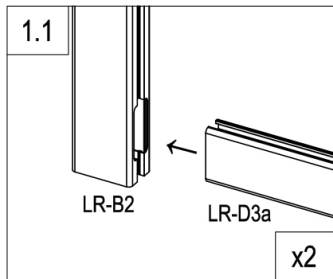
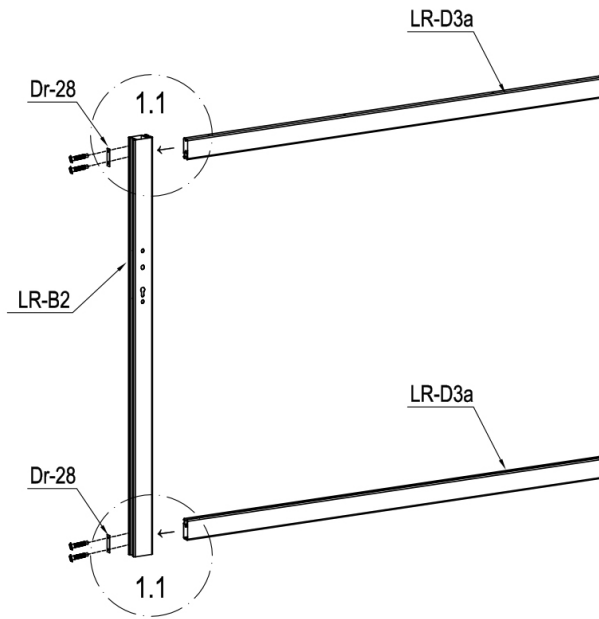



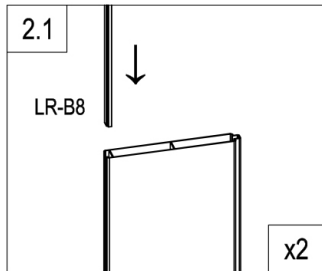
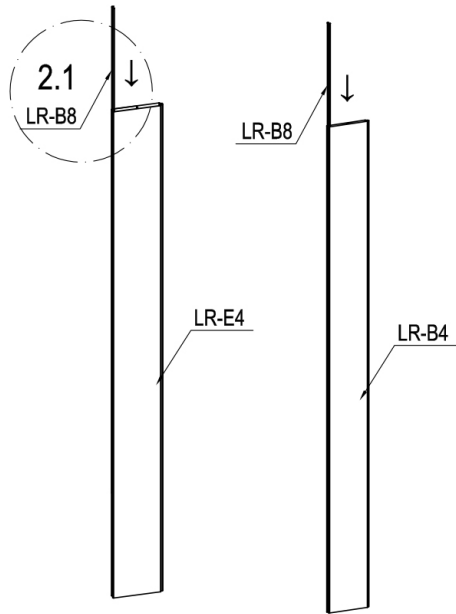





IMAGE	NO.	L.(mm)	QTY	IMAGE	NO.	L.(mm)	QTY
	LR-B1b	1573	2		Dr-14		1
	LR-B1c	1573	1		DO-30		4
	LR-B2	1573	1		AT-18	150	1
	AT-30	250	1		AT-18a	150	1
	AT-30a	250	1		ATW-14	420	1
	LR-D3a	1742	4		AT-19		4
	LR-E4	1400	16		AT-20		4
	LR-B4	1400	4		AT-21		1
	LR-E4a	1400	2		AT-22		1
	AT-A5b	1573	1		AT-23		2
	AT-C5	1448	1		Dr-18		1
	AT-A5a	395.5	1		Dr-19		1
	Dr-A5b	937	1		Dr-20a		1
	AT-29	193	2		Dr-21		1
	AT-A11	1573	4		Dr-22		1
	AT-A11a	250	2		Dr-25		1
	LR-D11	1742	4		Dr-25a		2
	AT-31	250	2		Dr-27		2
	LR-D6	25	8		Dr-28		6
	LR-B8	1400	4		AT-22J		7
	AT-A7a	1520	1		LR-S30		4
	LR-D14	1608	2		LR-S31		10
	LR-D14a	1608	2		LR-S32		32
	LR-D16	1607	2		LR-S33		4
	AT-16		1		LR-S34		12
	AT-B17	1412	5		LR-S35		50
	AT-17		2		LR-S36		2
	AT-17a		2		LR-S37		8
	AT-10		4		LR-S38		50
	Dr-13		1				





	LR-B2	1
	LR-D3a	2
	Dr-28	2
	LR-S32	4



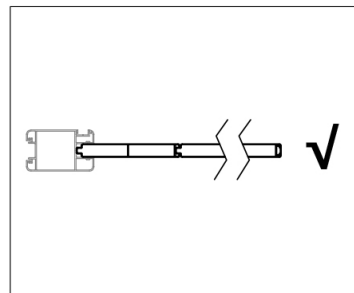
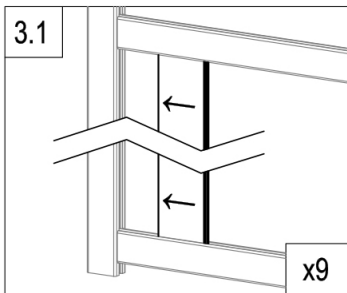
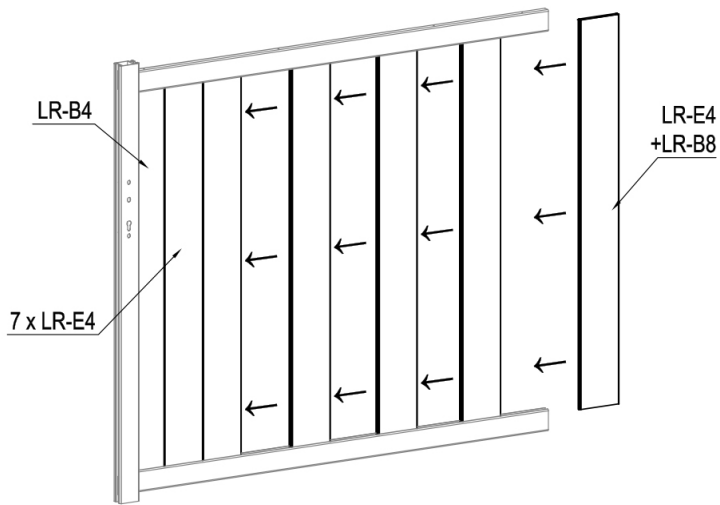

	LR-B8	2
	LR-E4	1
	LR-B4	1





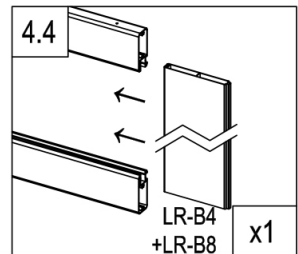
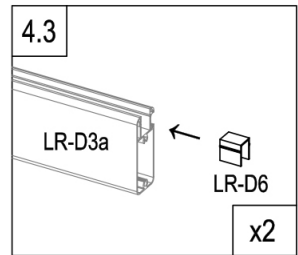
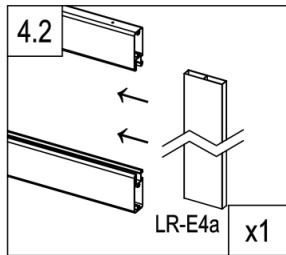
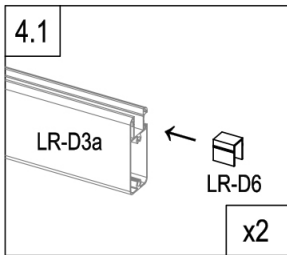
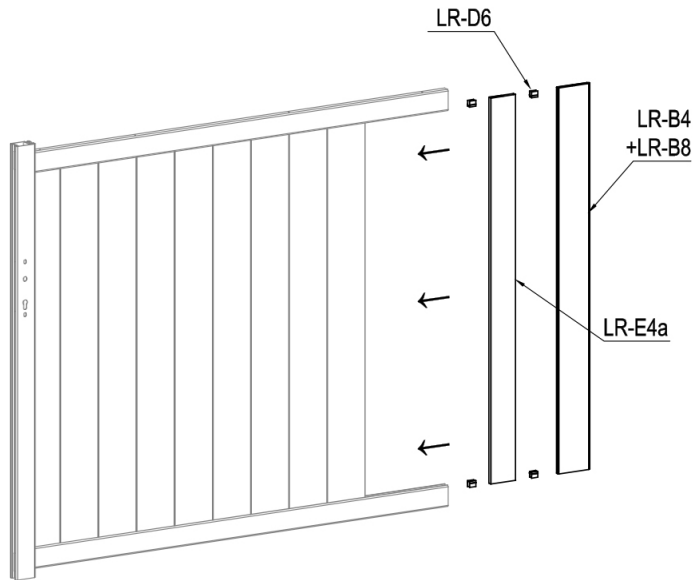



	LR-E4	7
	LR-B4	1

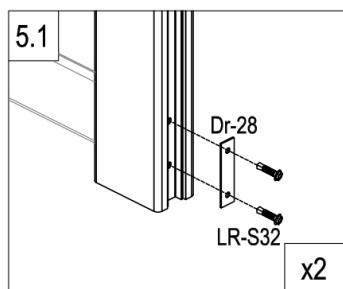
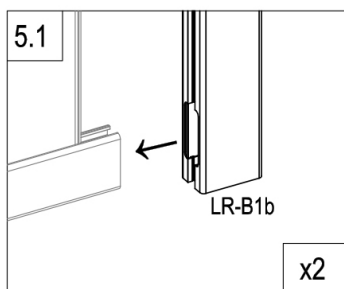
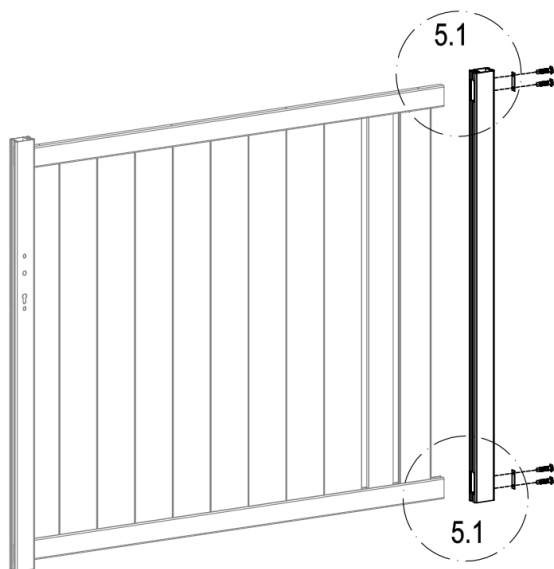



	LR-E4a	1
	LR-D6	4

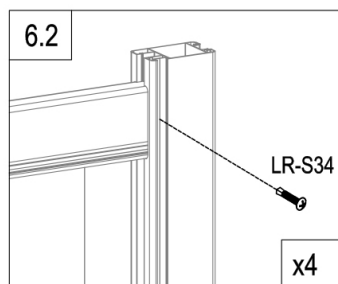
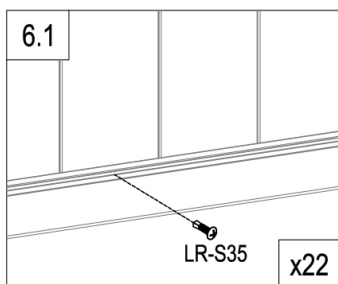
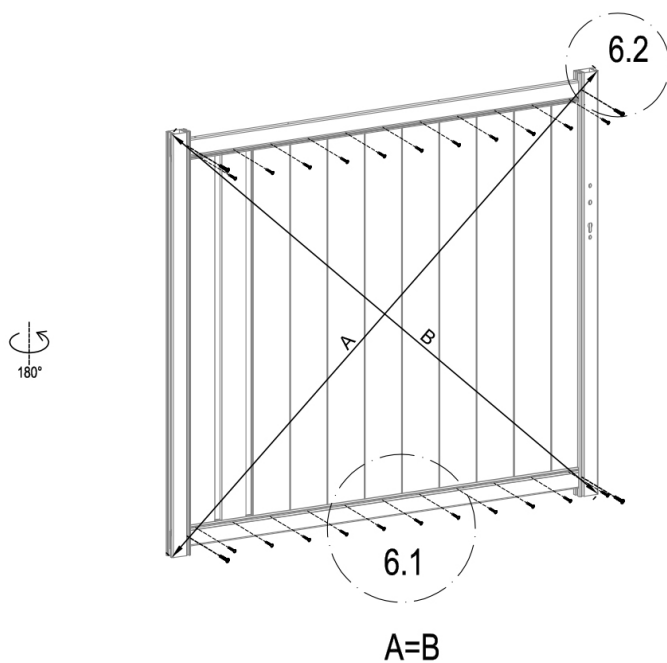

	LR-B1b	1
	Dr-28	2
	LR-S32	4



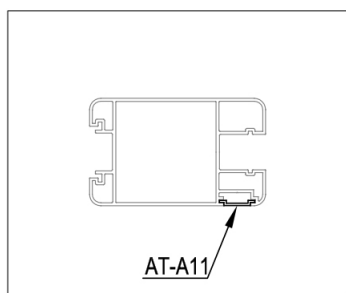
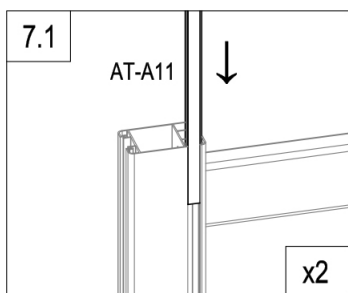
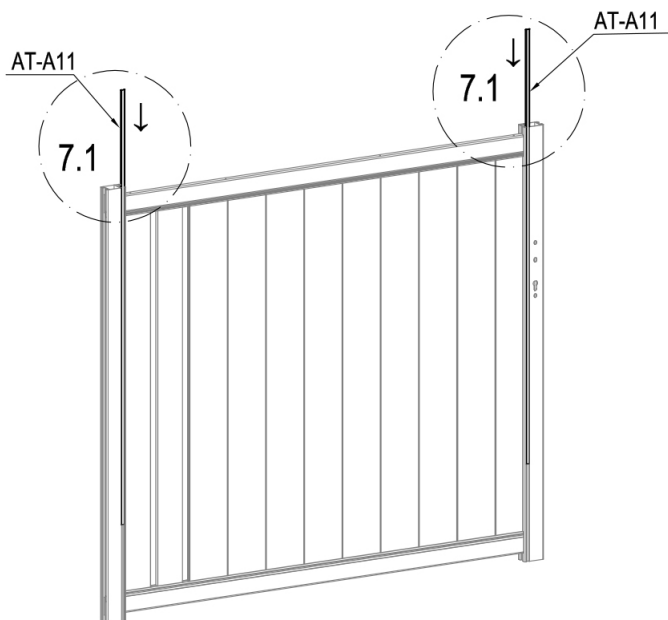

	LR-S35	22
	LR-S34	4

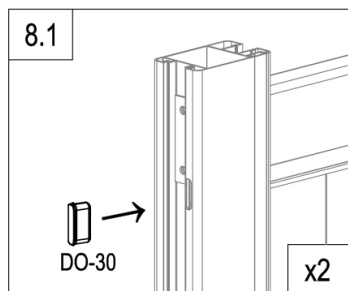
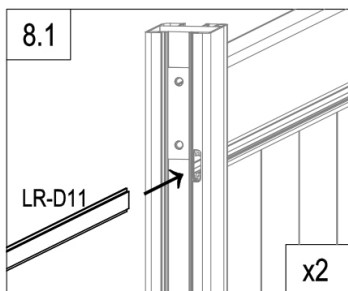
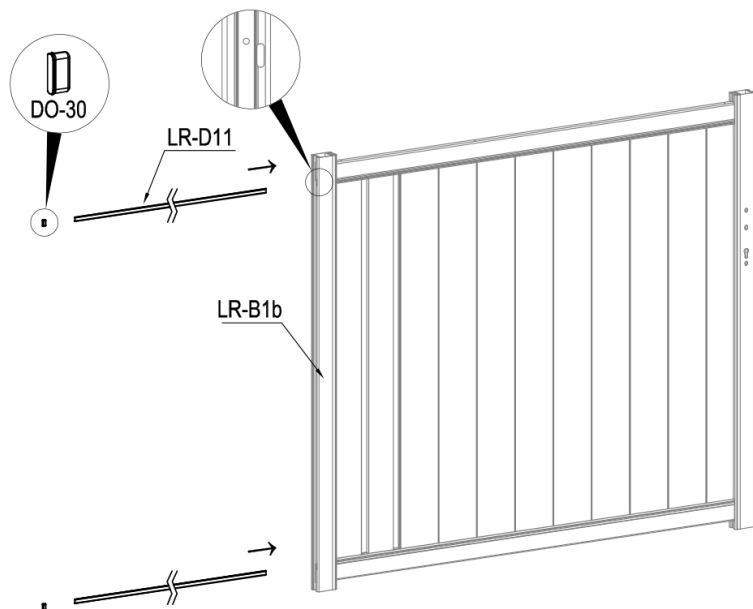

	AT-A11	2
---	--------	---



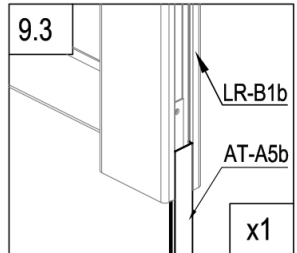
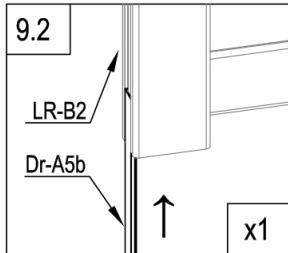
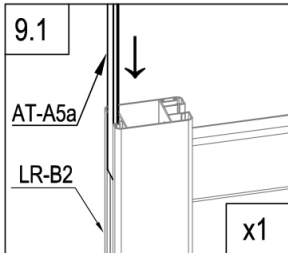
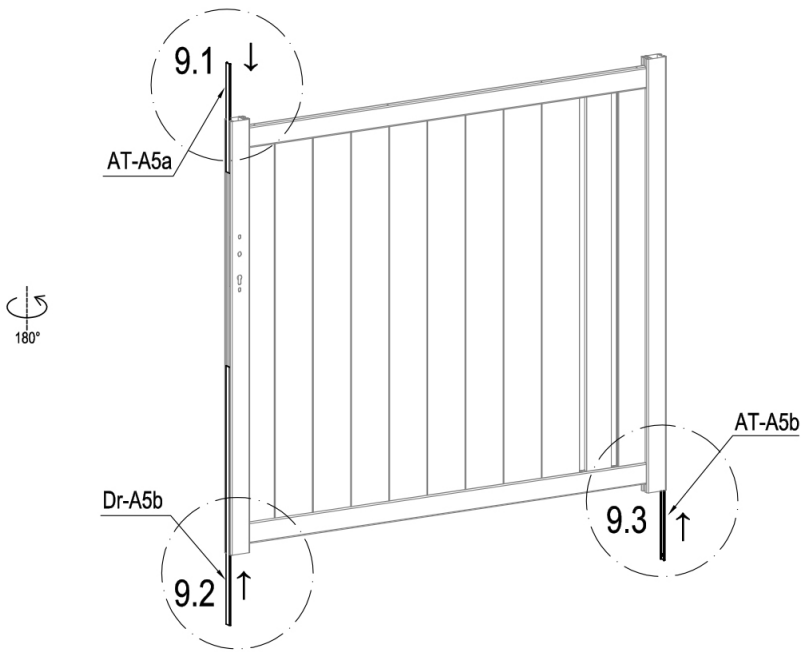

	LR-D11	2
	DO-30	2

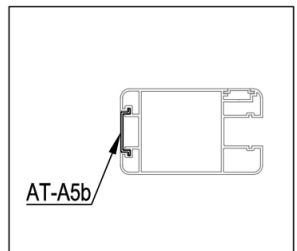

	AT-A5b	1
	AT-A5a	1
	Dr-A5b	1

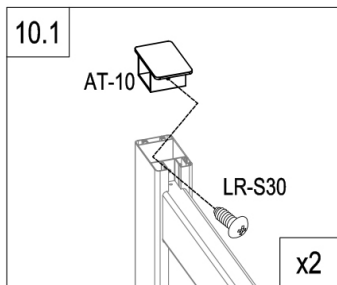
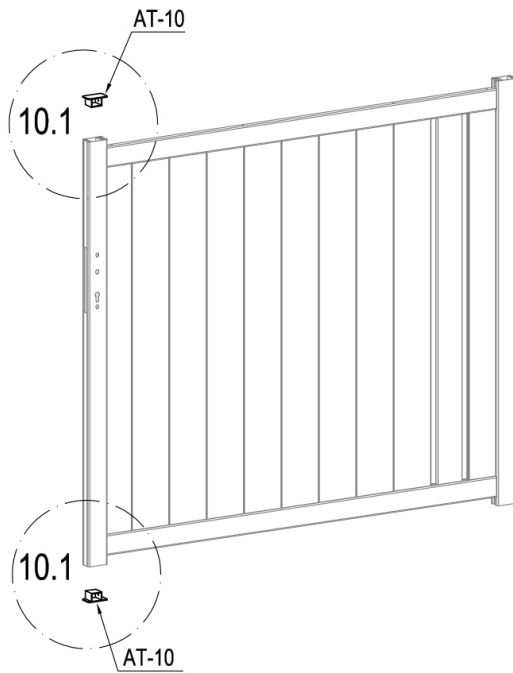







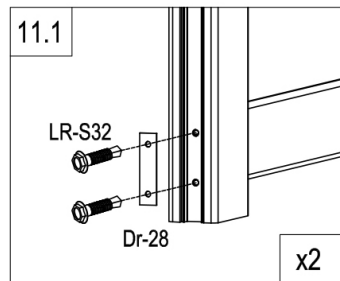
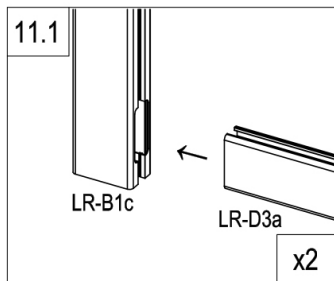
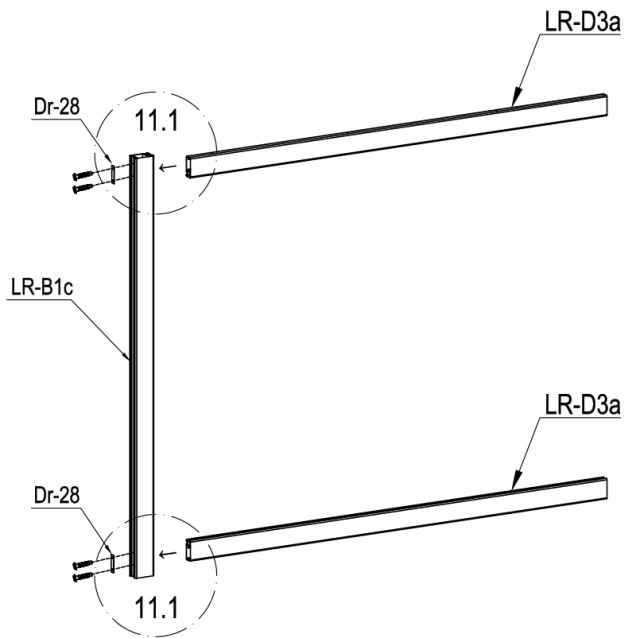



	AT-10	2
	LR-S30	2



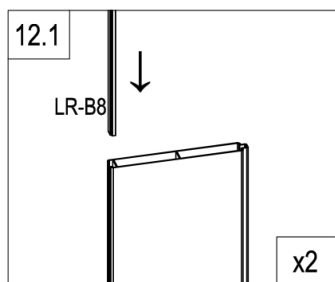
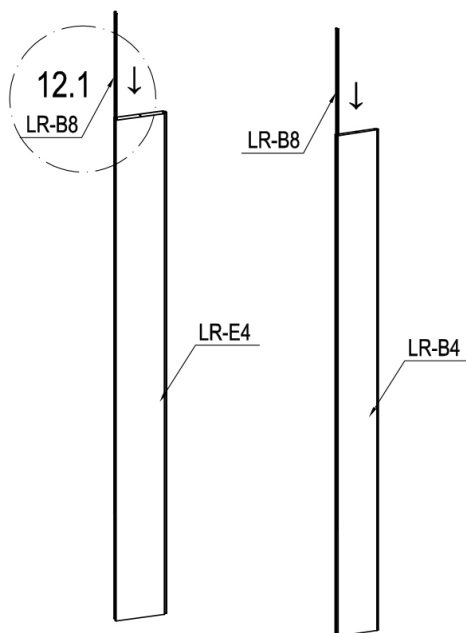



	LR-B1c	1
	LR-D3a	2
	Dr-28	2
	LR-S32	4



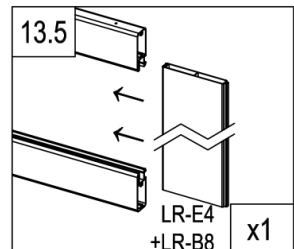
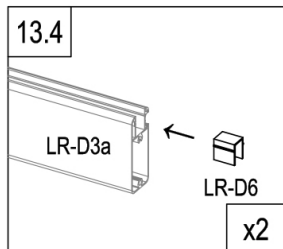
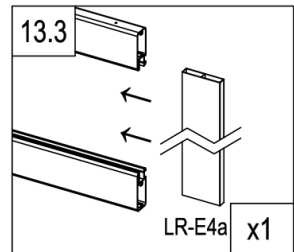
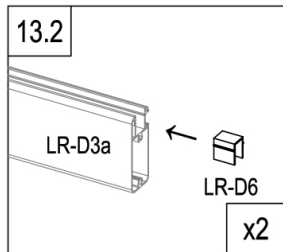
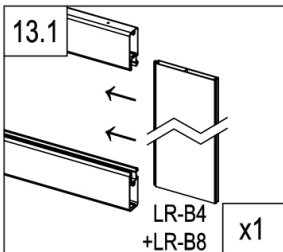
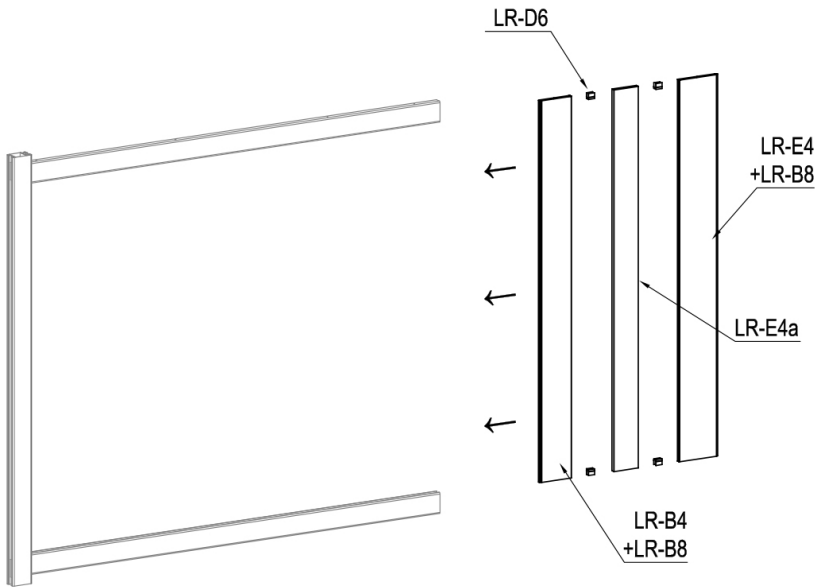

	LR-B8	2
	LR-E4	1
	LR-B4	1



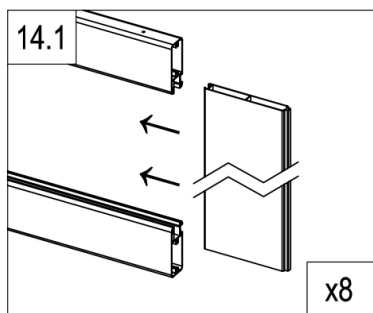
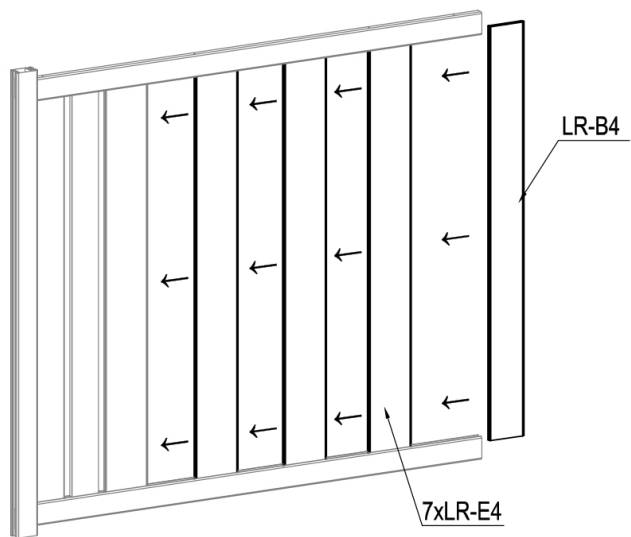

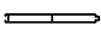
	LR-E4a	1
	LR-D6	4



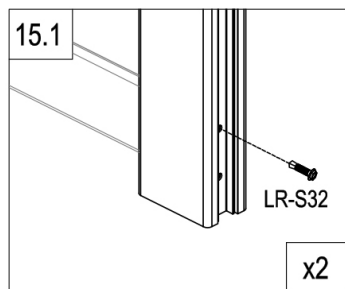
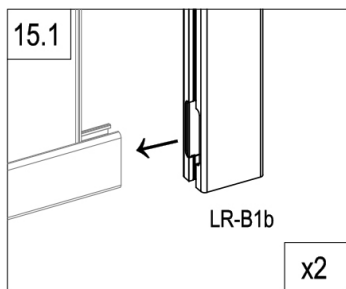
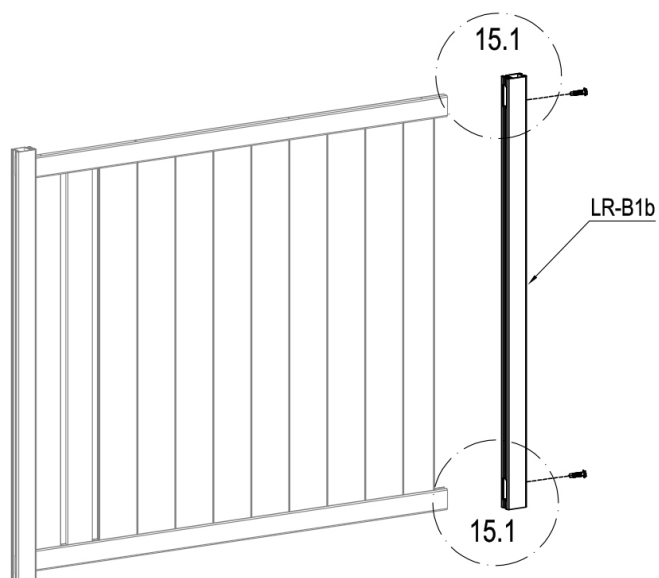

	LR-E4	7
	LR-B4	1

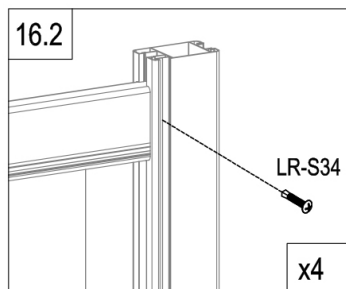
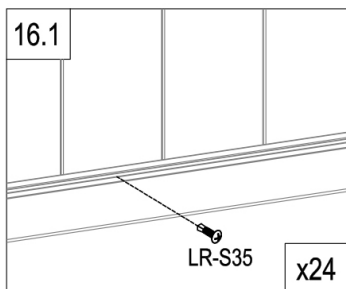
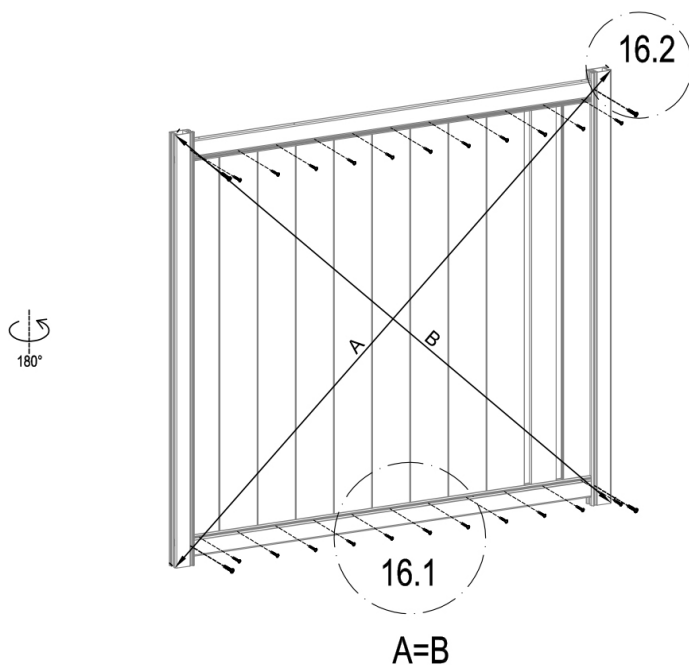

	LR-B1b	1
	LR-S32	2



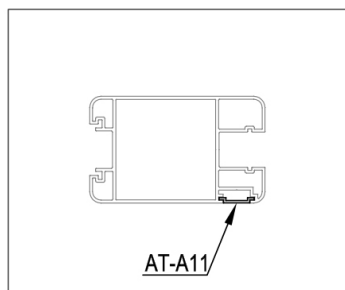
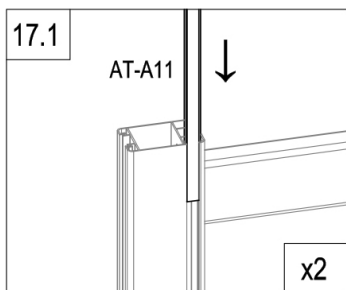
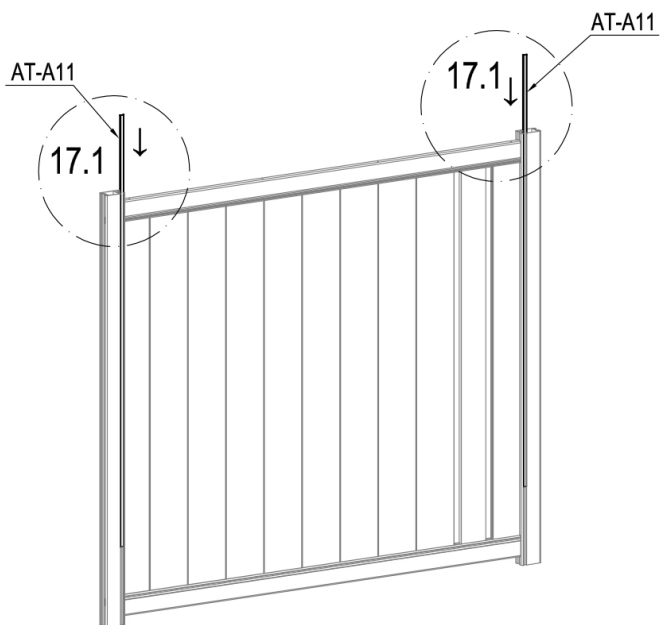

	LR-S35	24
	LR-S34	4

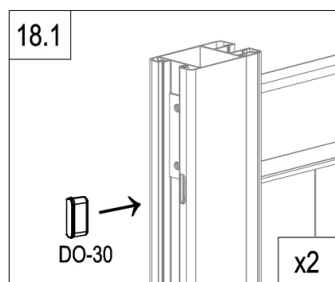
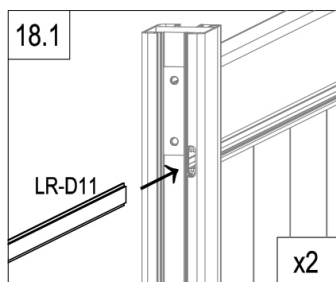
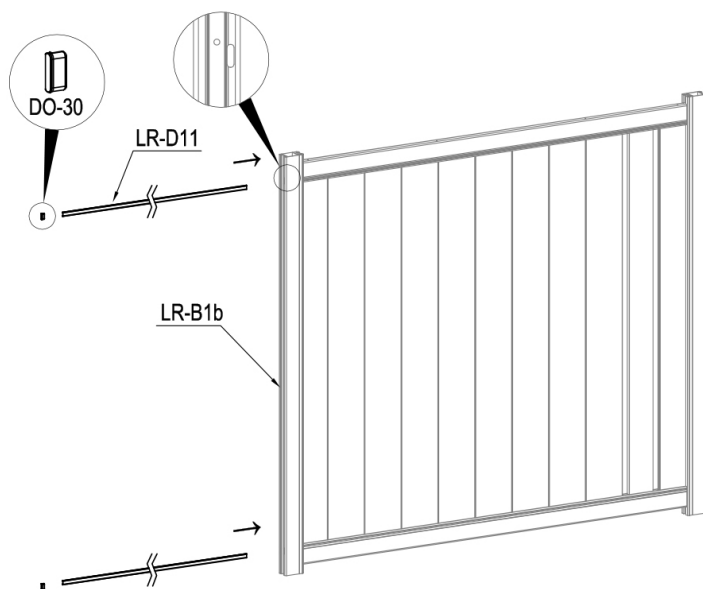

	AT-A11	2
---	--------	---





	LR-D11	2
	DO-30	2

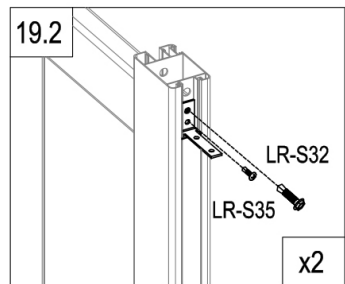
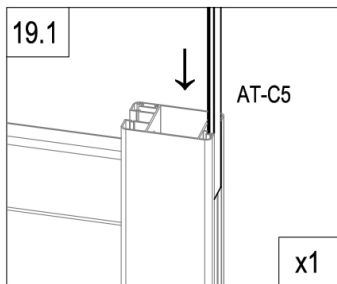
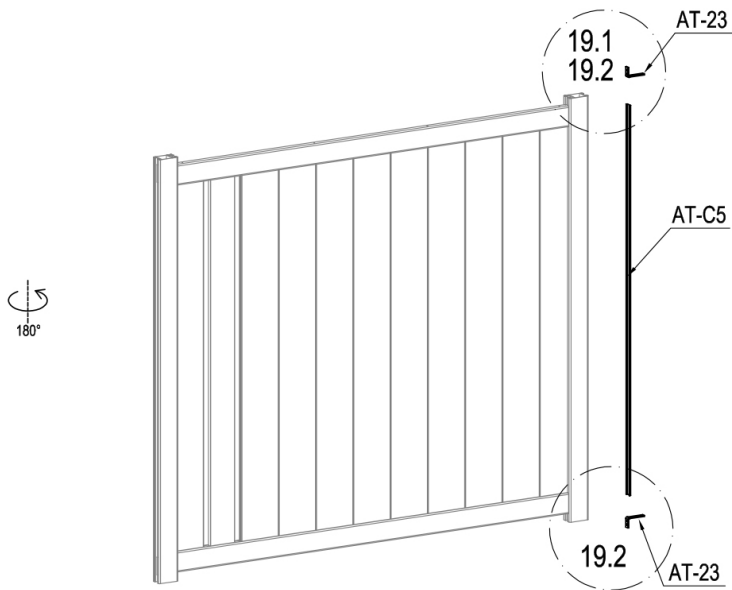



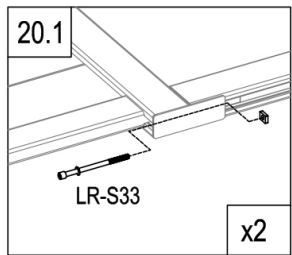
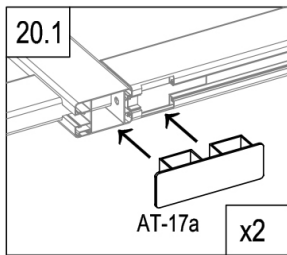
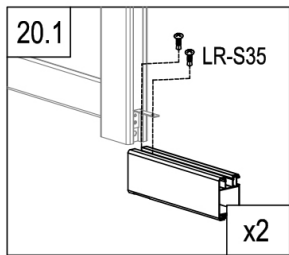
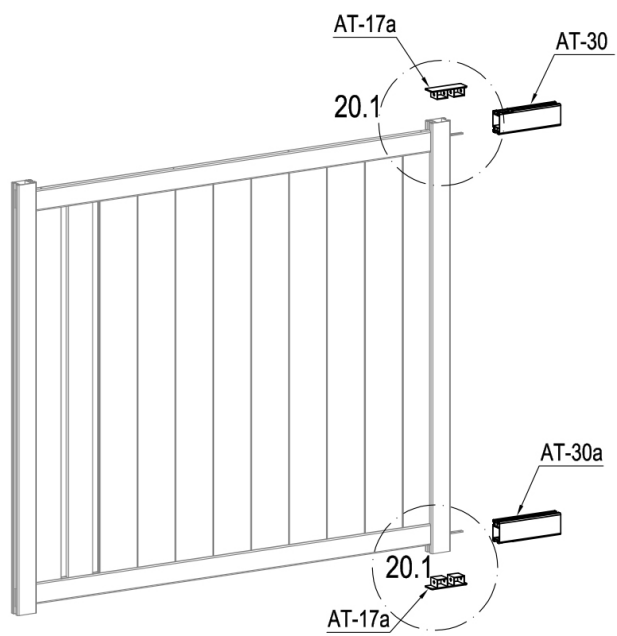





	AT-C5	1
	AT-23	2
	LR-S32	2
	LR-S35	2



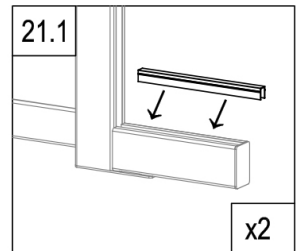
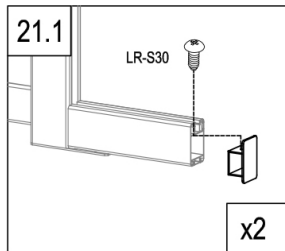
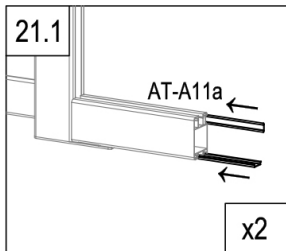
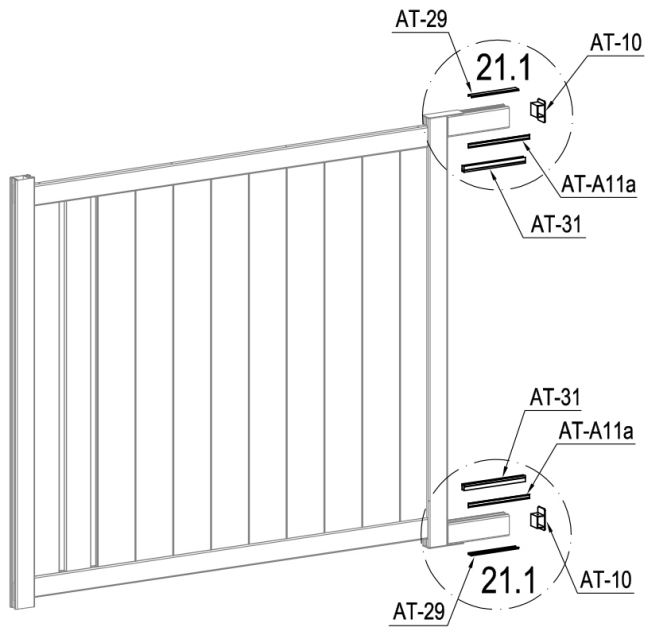

	AT-30	1
	AT-30a	1
	AT-17a	2



	LR-S33	2
	LR-S35	4



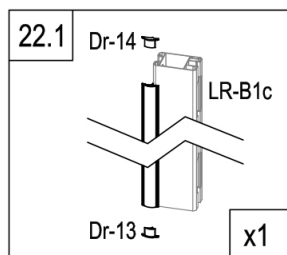
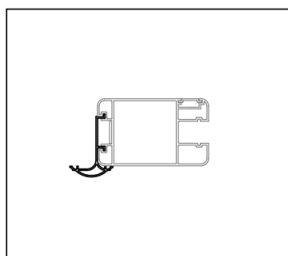
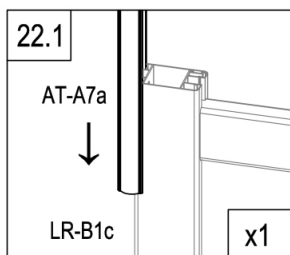
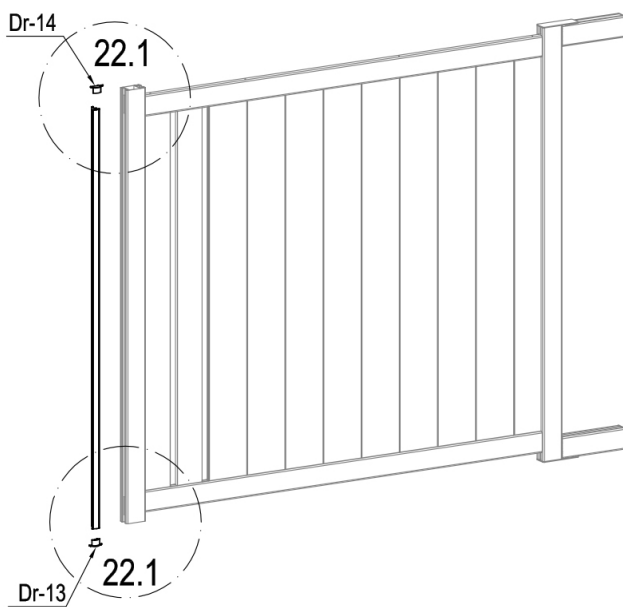

	AT-29	2
	AT-A11a	2
	AT-31	2

	AT-10	2
	LR-S30	2



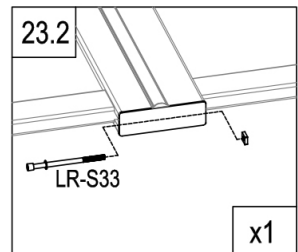
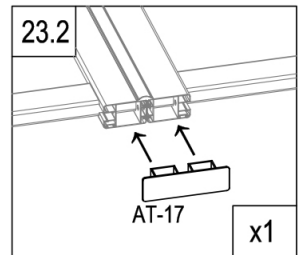
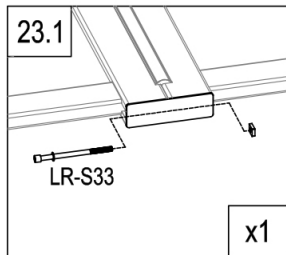
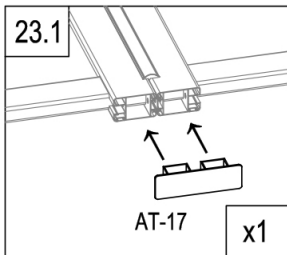
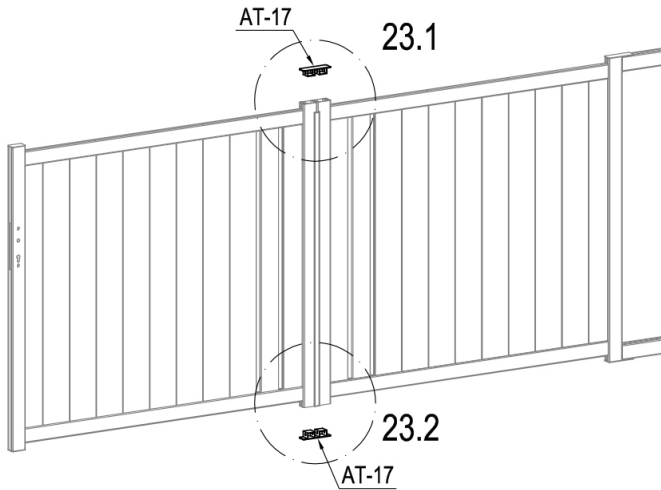

	AT-A7a	1
	Dr-13	1
	Dr-14	1

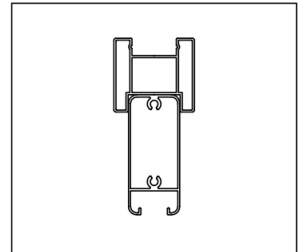
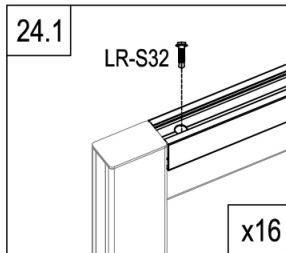
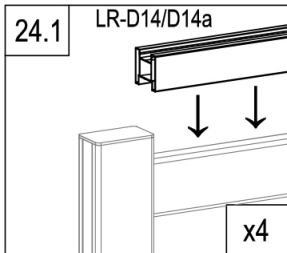
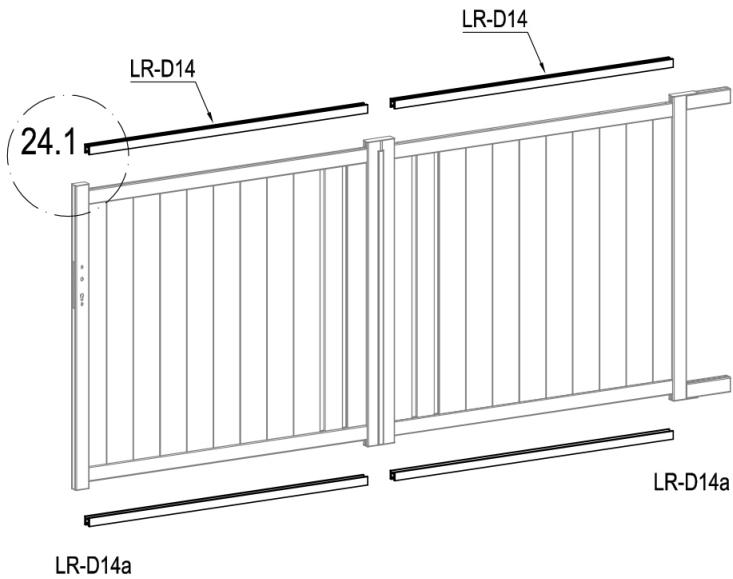

	AT-17	2
	LR-S33	2



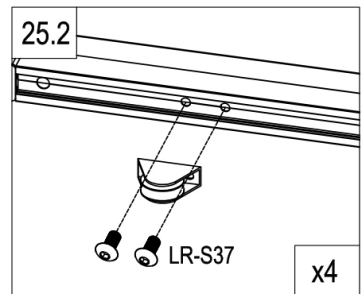
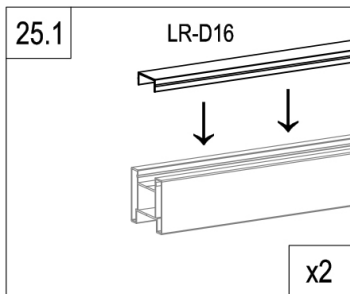
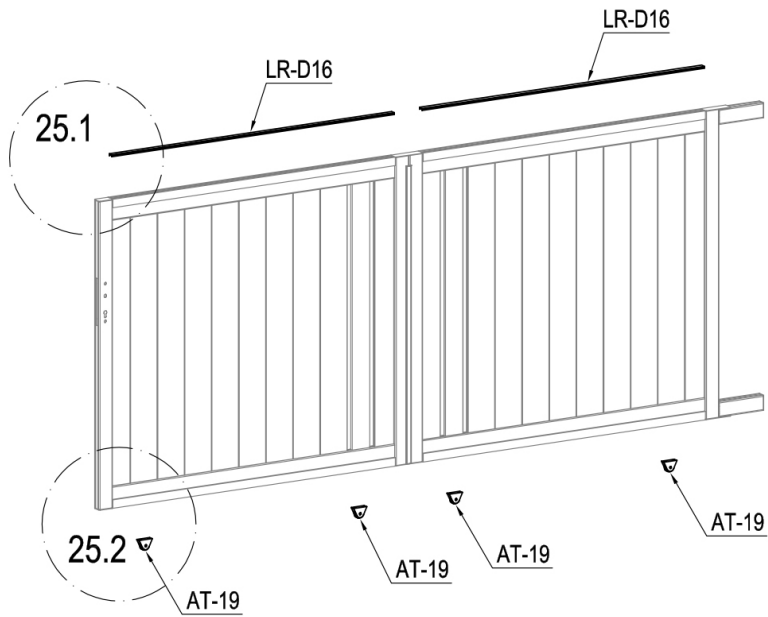

	LR-D14	2
	LR-D14a	2
	LR-S32	16

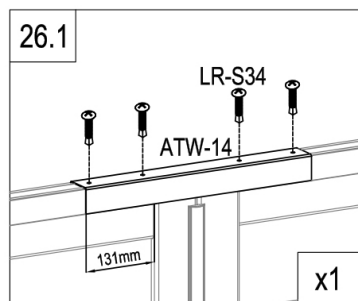
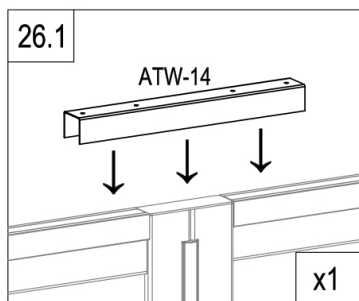
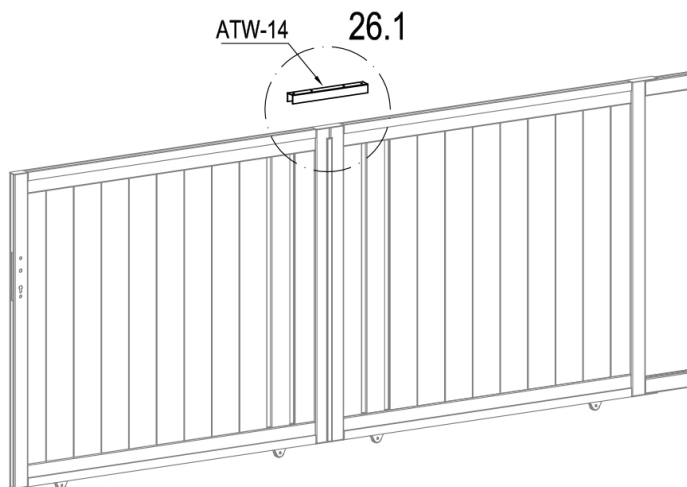

	LR-D16	2
	AT-19	4
	LR-S37	8



	ATW-14	1
	LR-S34	4



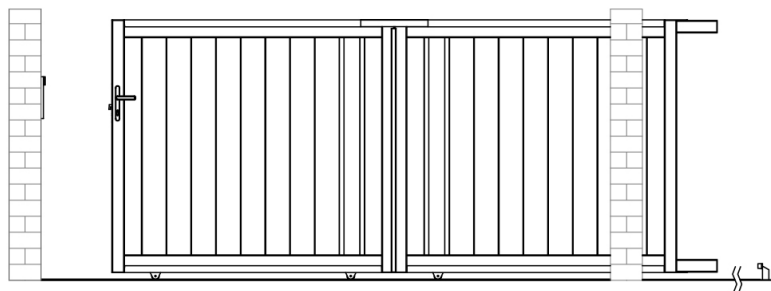

**L** : P27~32

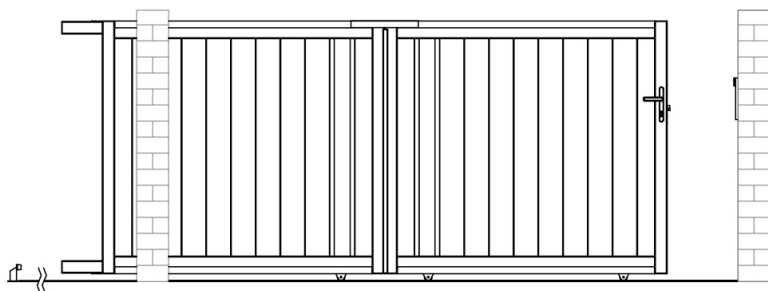

**R** : P33~38

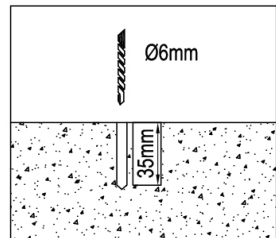
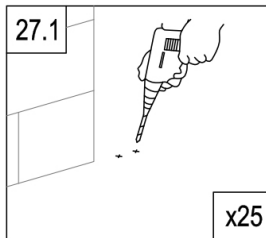
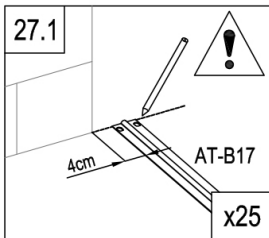
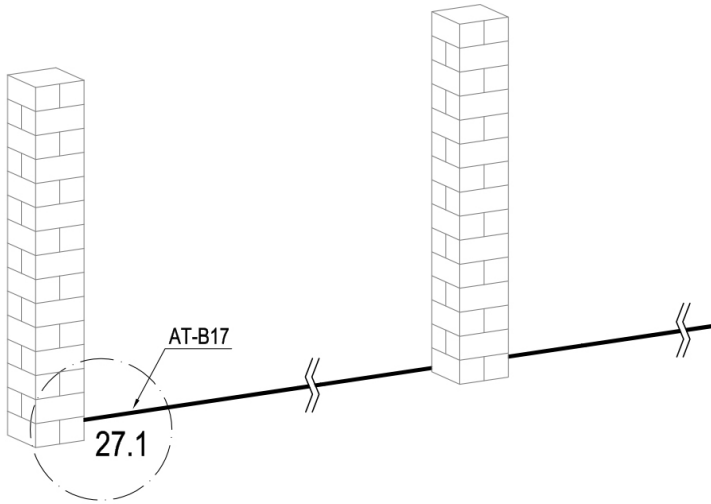

	AT-B17	5
	LR-S38	50

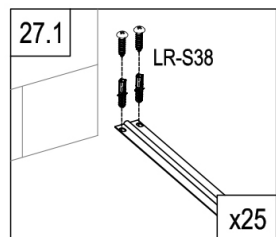

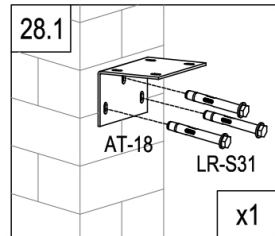
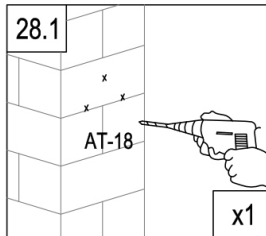
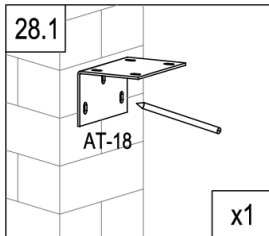
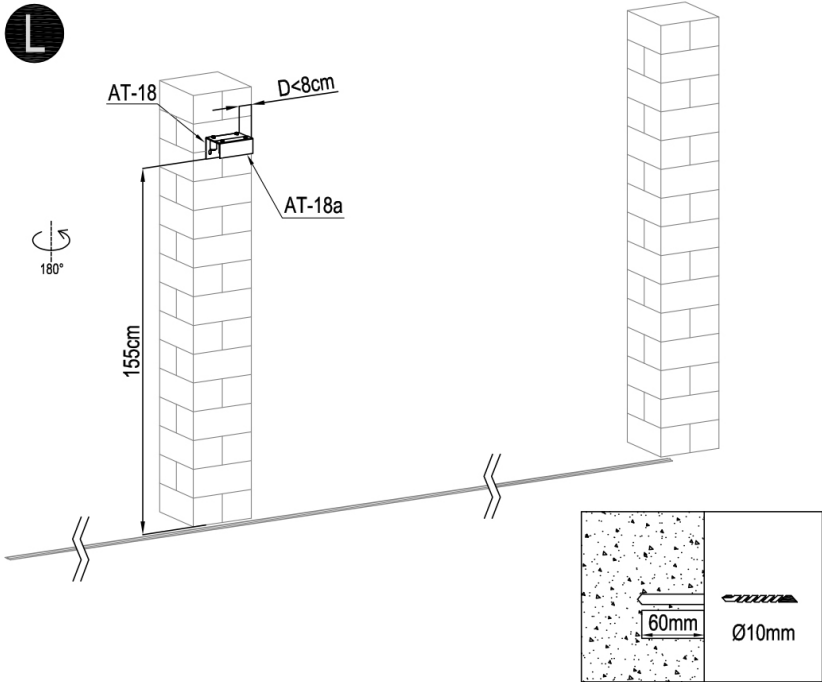

	AT-18	1
	AT-18a	1
	AT-20	4
	LR-S31	3

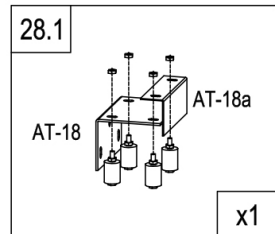
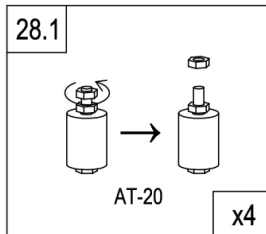

L

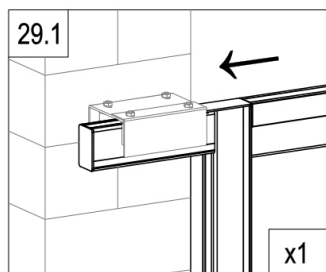
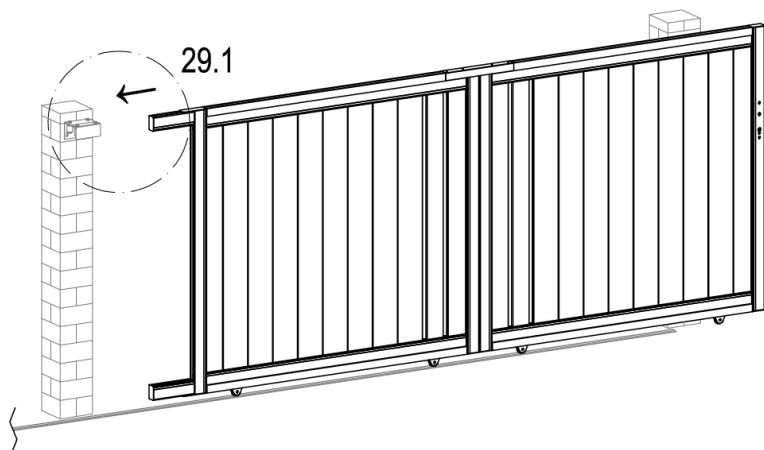

L

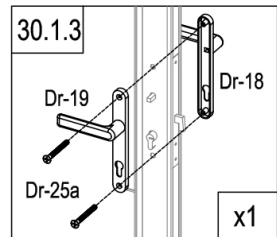
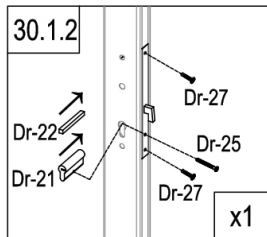
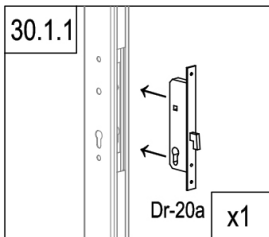
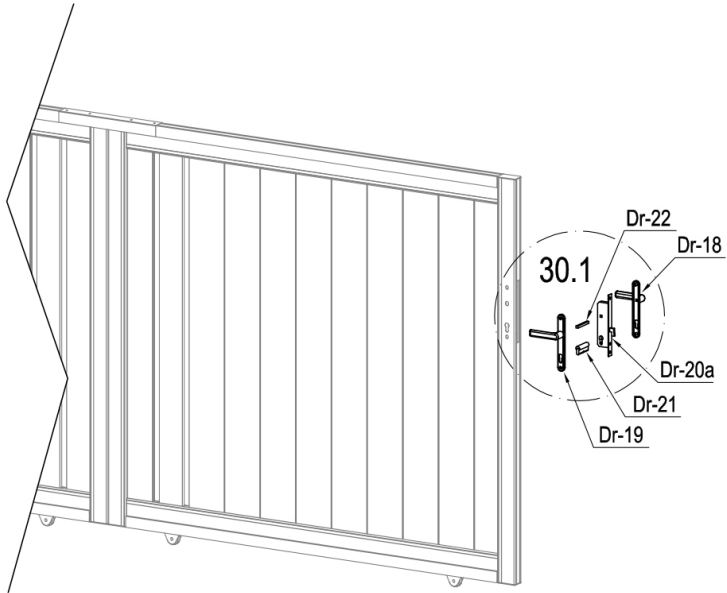

	Dr-20a	1
	Dr-21	1
	Dr-22	1
	Dr-25	1

	Dr-18	1
	Dr-19	1
	Dr-25a	2
	Dr-27	2

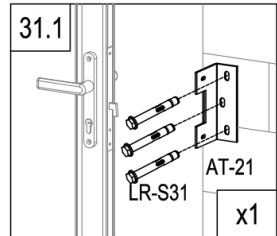
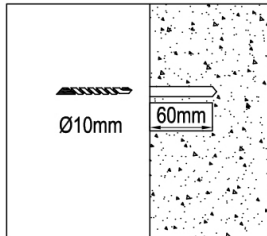
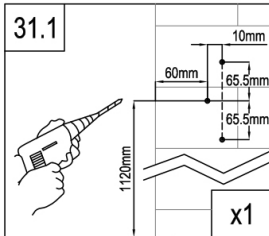
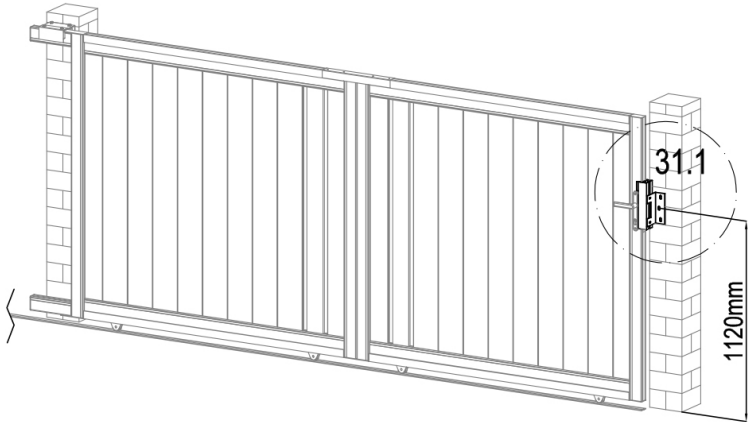

	AT-16	1
	AT-21	1
	LR-S36	2
	LR-S31	3
	AT-22J	3

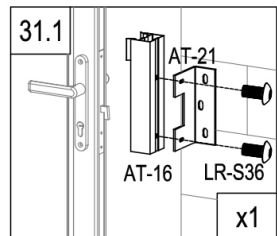
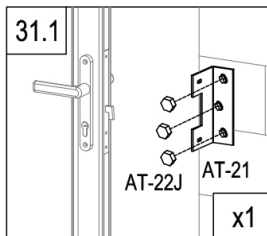

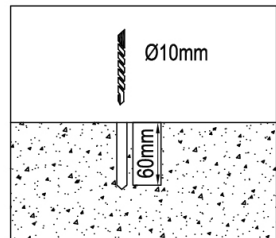
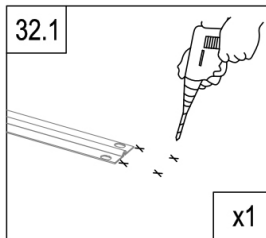
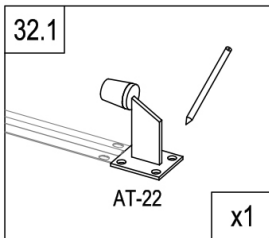
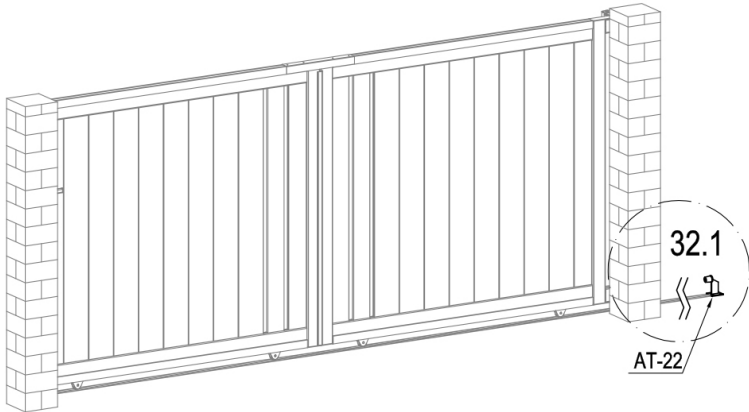

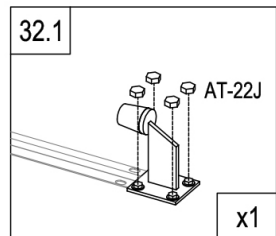
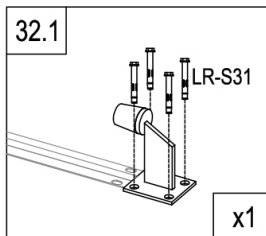

	AT-22	1
	LR-S31	4
	AT-22J	4

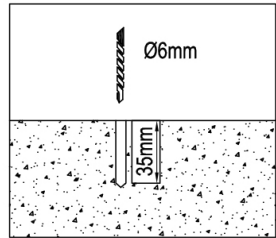
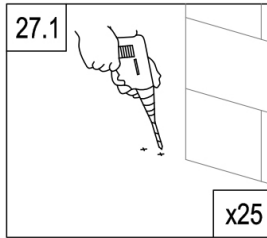
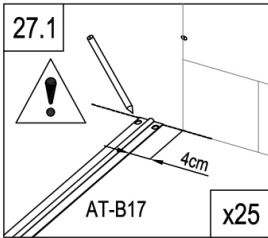
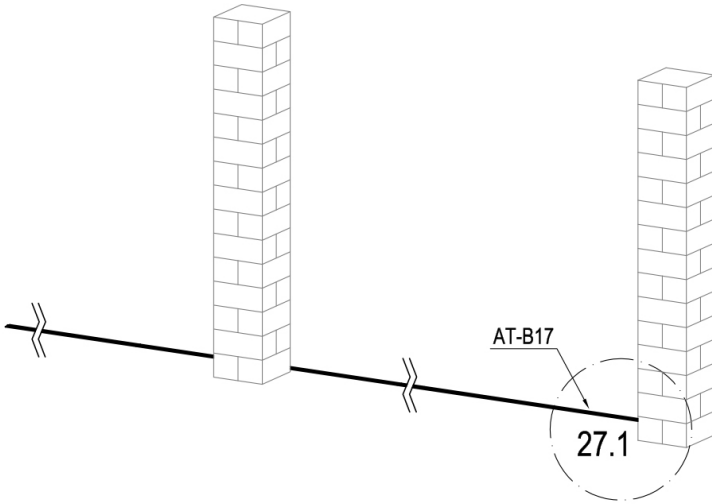

R



	AT-B17	5
	LR-S38	50

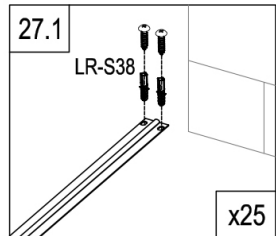



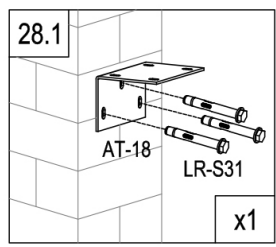
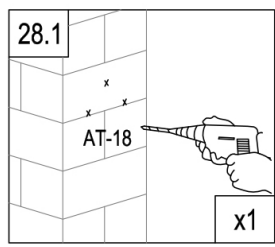
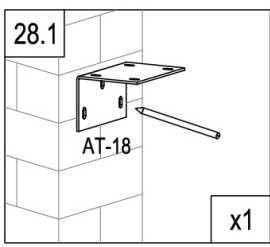
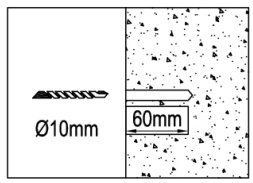
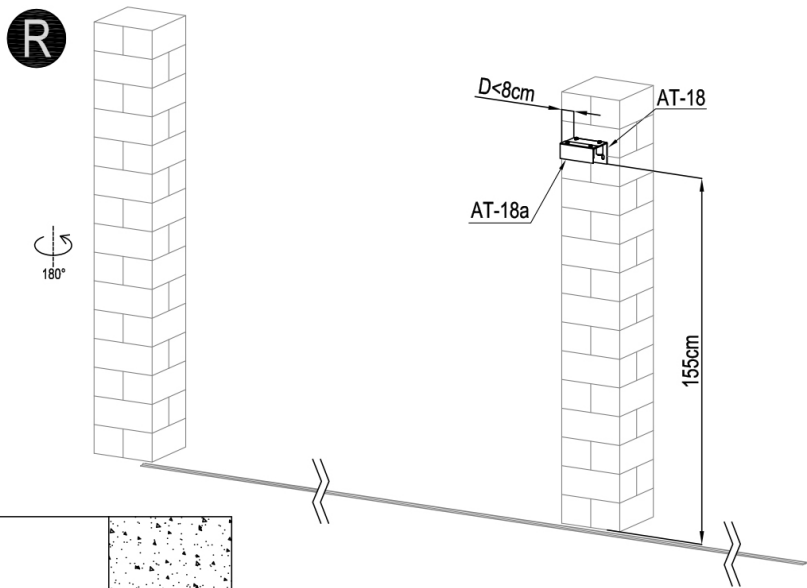

	AT-18	1
	AT-18a	1
	AT-20	4
	LR-S31	3

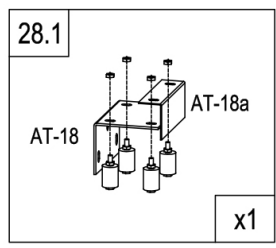
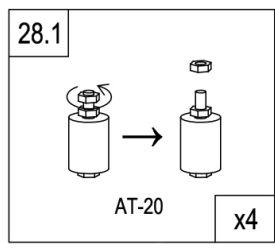

R

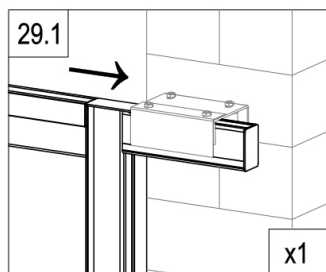
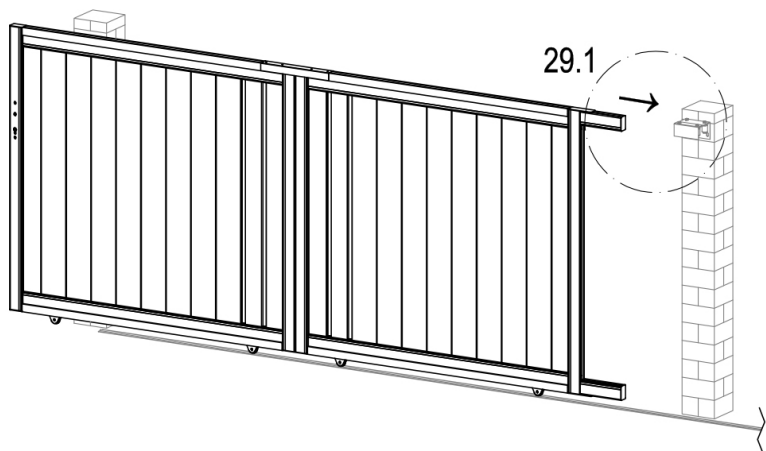

R

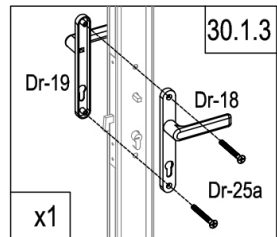
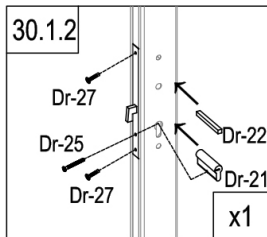
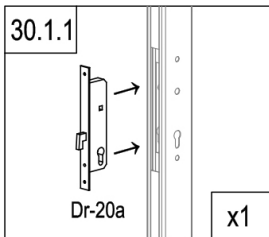
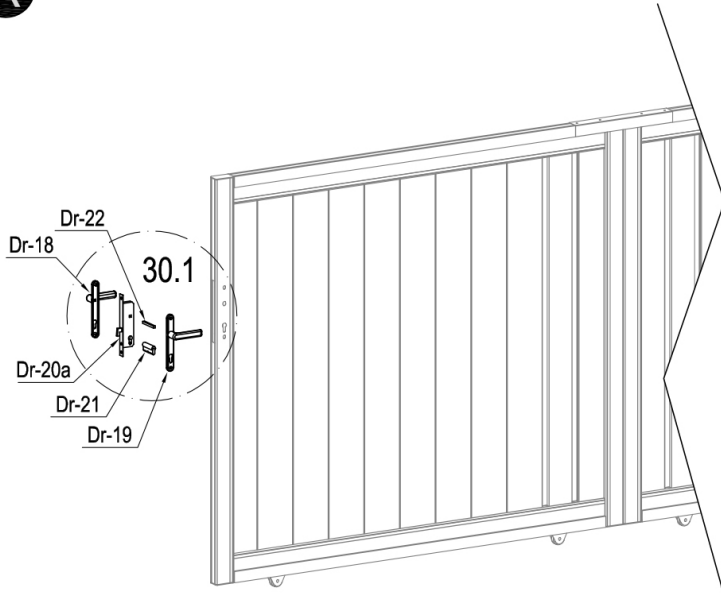

	Dr-20a	1
	Dr-21	1
	Dr-22	1
	Dr-25	1

	Dr-18	1
	Dr-19	1
	Dr-25a	2
	Dr-27	2

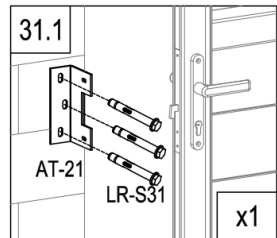
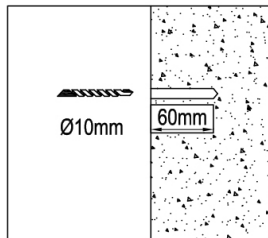
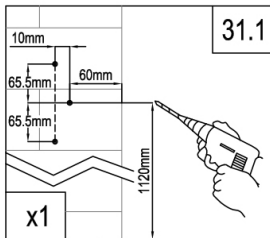
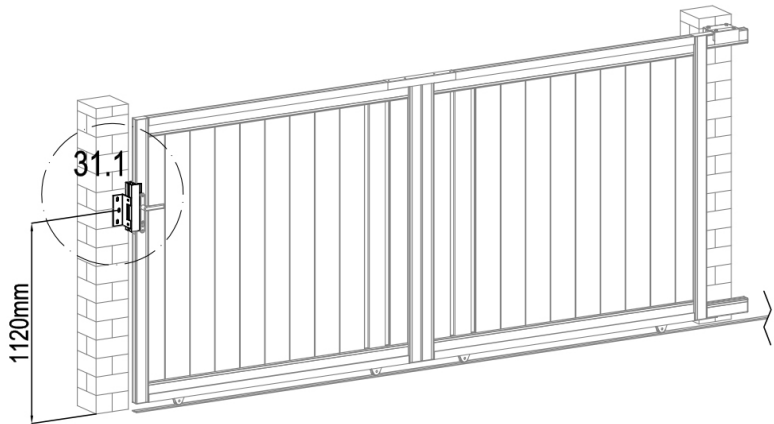

	AT-16	1
	AT-21	1
	LR-S36	2
	LR-S31	3
	AT-22J	3

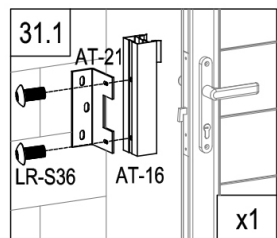
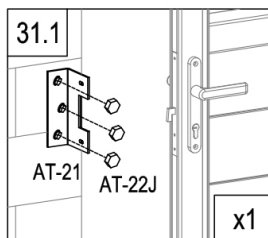

R

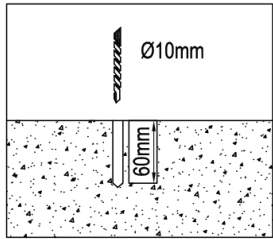
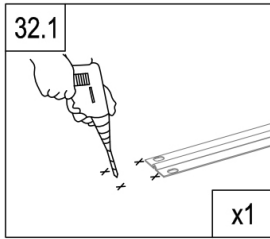
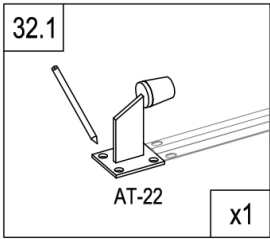
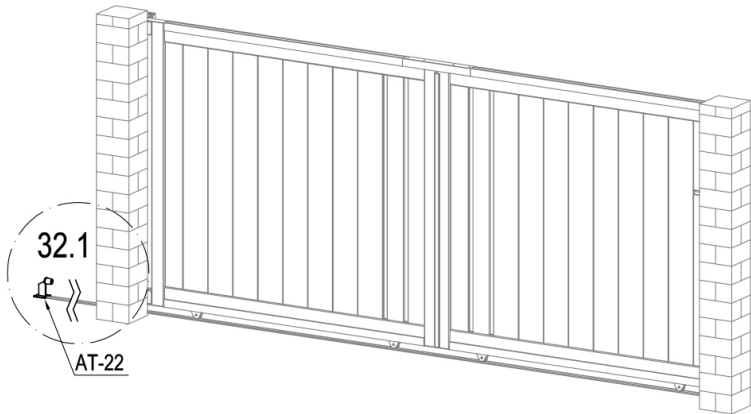

	AT-22	1
	LR-S31	4
	AT-22J	4

