

CASANOVO

GIONA 300B180

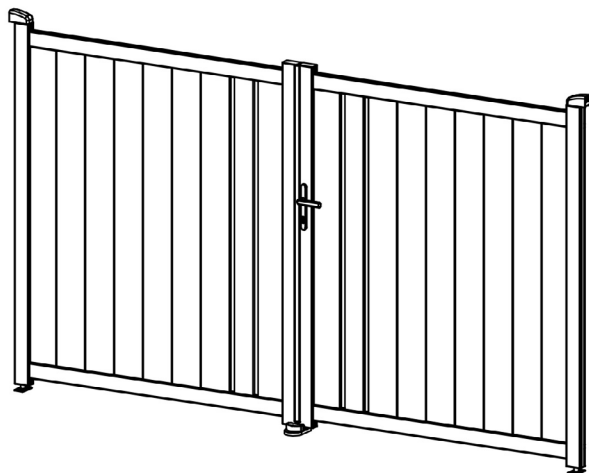

COM-001134 [x1]

COM-001135 [x1]

COM-001136 [x1]





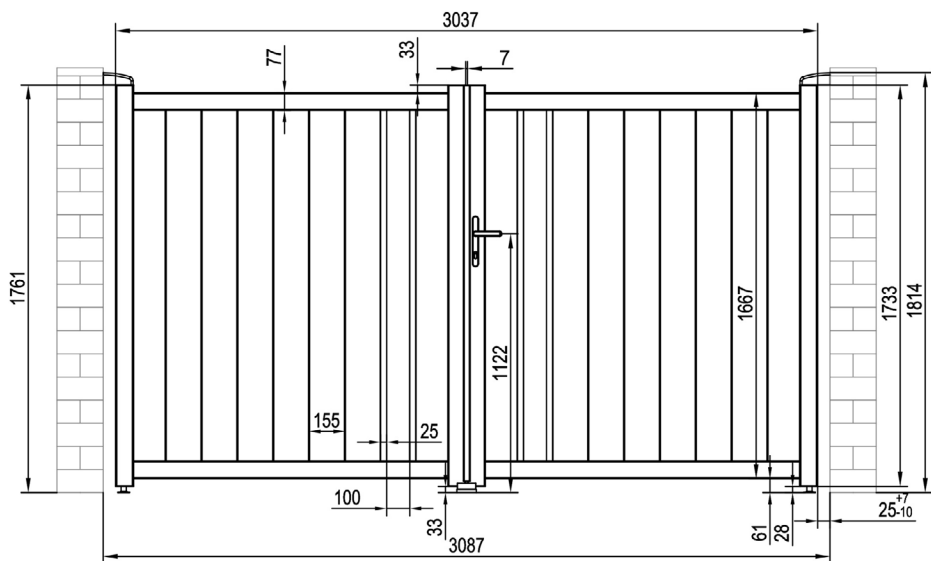

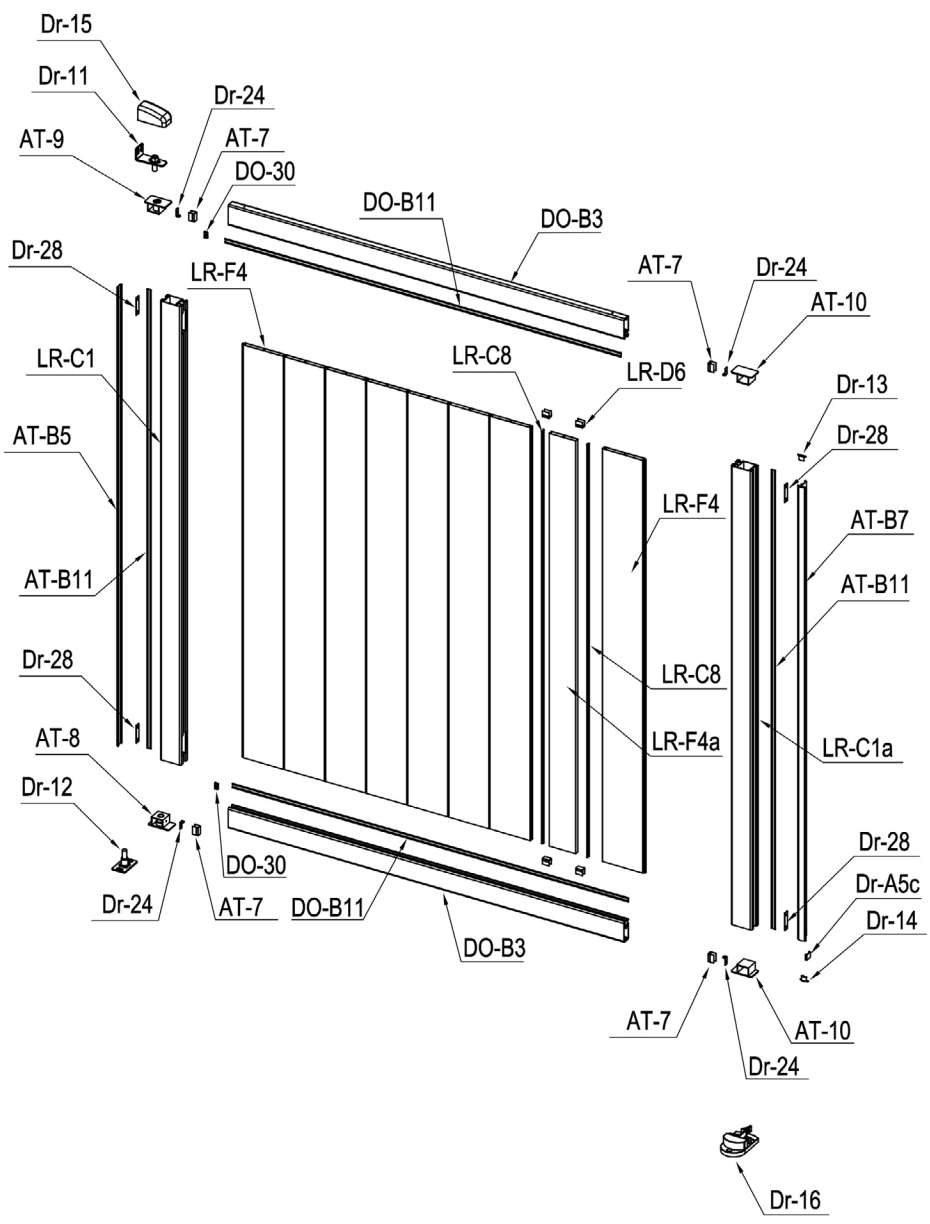

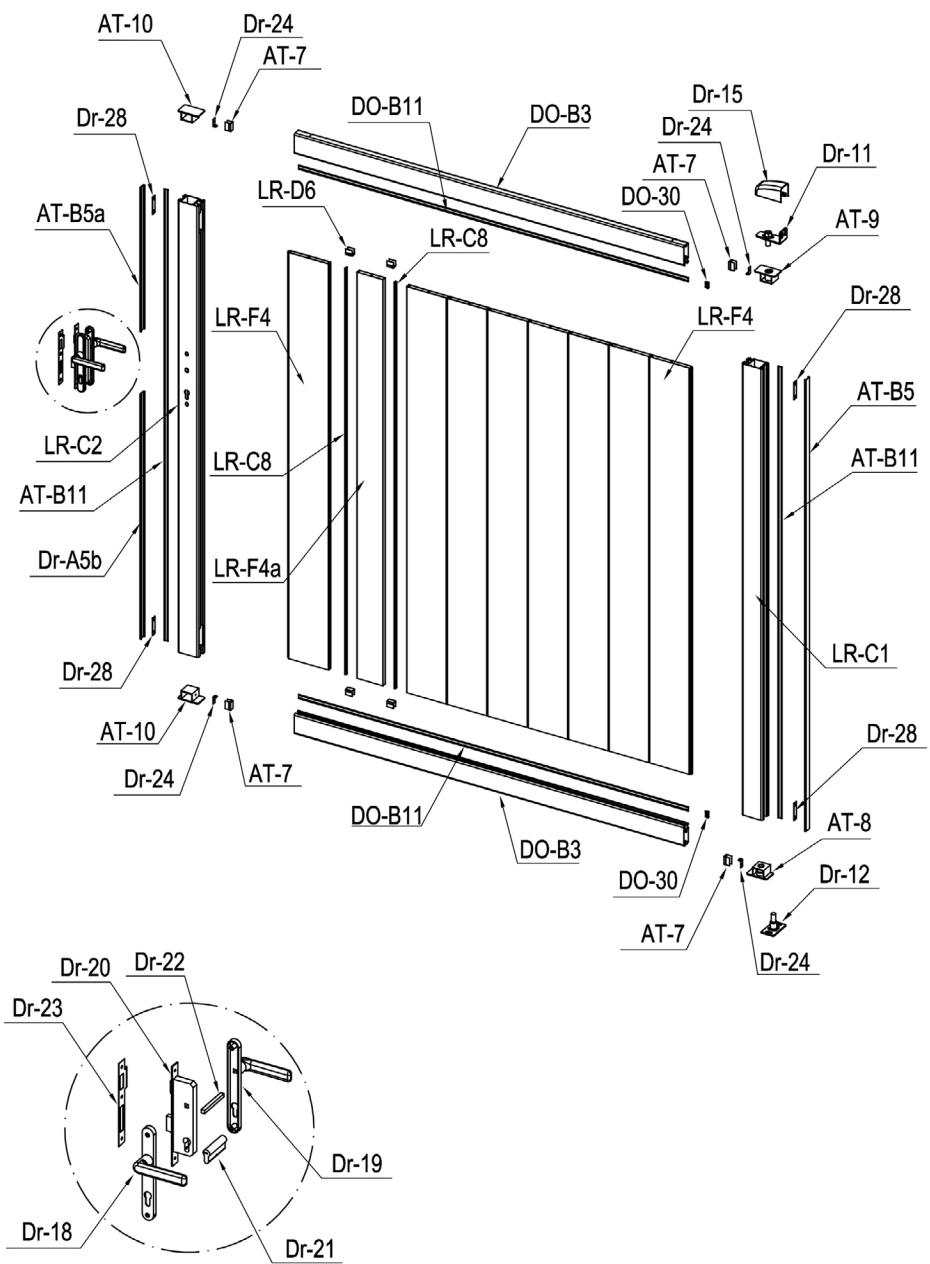

































INSTRUCTION MANUAL / NOTICE DE MONTAGE / MONTAGEANLEITUNG / MANUAL DE MONTAJE / MANUAL DE MONTAGEM / MANUALE DI MONTAGGIO /
MONTAGEHANDLEIDING / INSTRUKCJA MONTAŻU / KÄYTTÖOHJEET / BRUKSANVISNING / BRUGSANVISNING / INSTRUCȚIUNI DE ASAMBLARE /
NAVODILA ZA SESTAVLJANJE / NÁVOD NA MONTÁŽ / ÖSSZESZERELÉSI ÚTMUTATÓ / NÁVOD K MONTÁŽI / UPUTE ZA INSTALACIJU /
ΟΔΗΓΙΕΣ ΣΥΝΑΡΜΟΛΟΓΗΣΗΣ / SURINKIMO INSTRUKCIJOS / MONTĀŽAS INSTRUKCIJAS









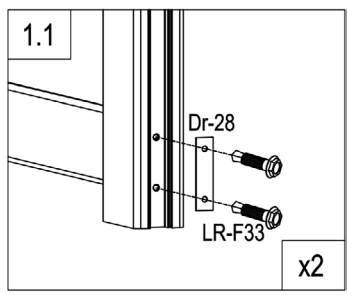
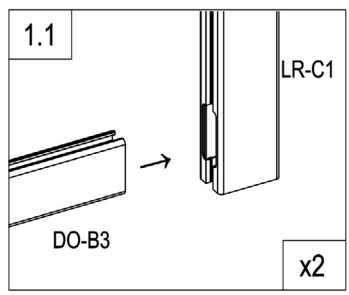
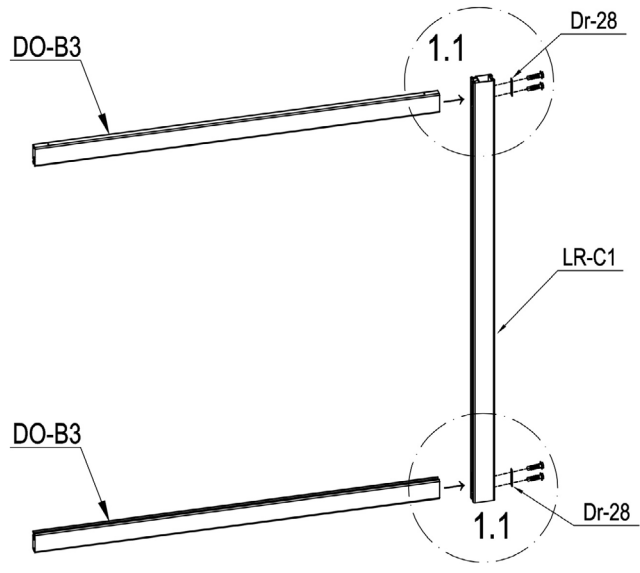

PART LIST

IMAGE	NO.	L.(mm)	QTY	IMAGE	NO.	L.(mm)	QTY
	LR-C1	1728	2		Dr-17		2
	LR-C1a	1728	1		Dr-31		4
	LR-C2	1728	1		DO-30		4
	DO-B3	1492	4		Dr-18		1
	LR-F4	1555	16		Dr-19		1
	LR-F4a	1555	2		Dr-20		1
	AT-B5	1728	2		Dr-21		1
	AT-B5a	550.5	1		Dr-22		1
	Dr-A5b	937	1		Dr-23		1
	Dr-A5c	19.5	1		Dr-25		1
	AT-B11	1728	4		Dr-25a		2
	DO-B11	1492	4		Dr-26		3
	AT-7	29.5	8		Dr-27		2
	LR-D6	25	8		Dr-24		8
	LR-C8	1555	4		Dr-28		8
	AT-B7	1708	1		LR-F30	ST4x10	8
	AT-8		2		LR-F31	ST4.2x13	44
	AT-9		2		LR-F32	M8x60	12
	AT-10		4		LR-F33	ST5.5x38	16
	Dr-11		2		LR-F34	ST6x40	3
	Dr-12		2		LR-F35	Ø6	3
	Dr-13		1		LR-F36	ST4.8x38	8
	Dr-14		1				
	Dr-15		2				
	Dr-16		1				

CASANOVA



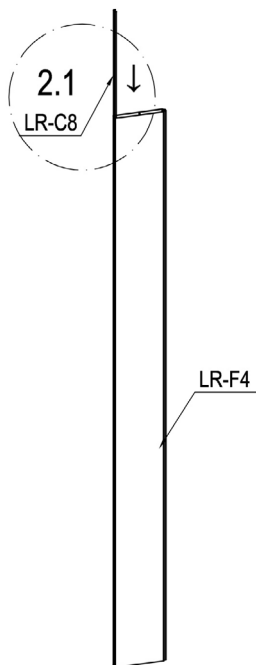

	LR-C1	1
	DO-B3	2
	Dr-28	2
	LR-F33	4



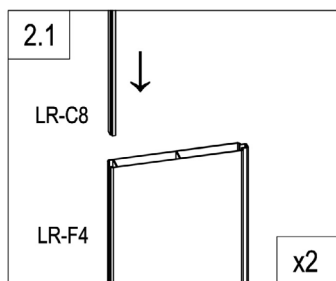

x2



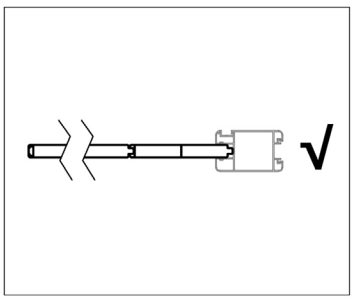
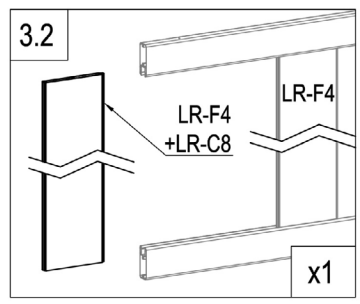
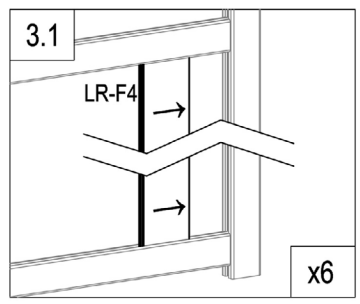
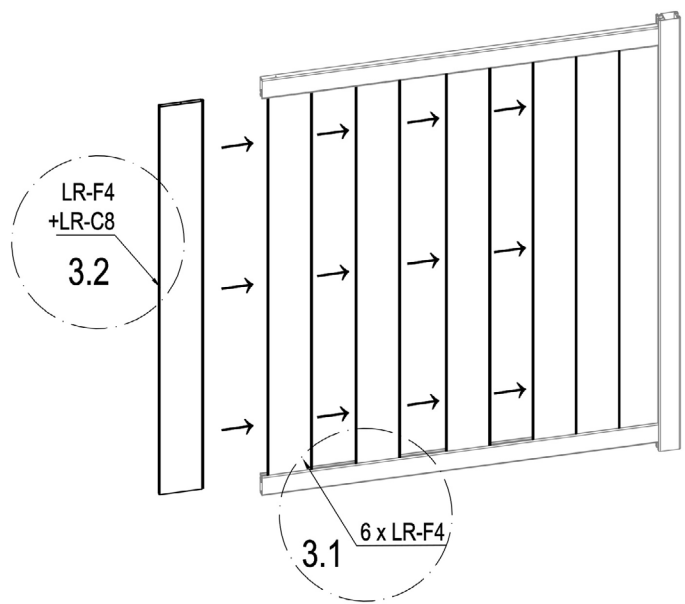

	LR-C8	2
	LR-F4	2

CASANOVO



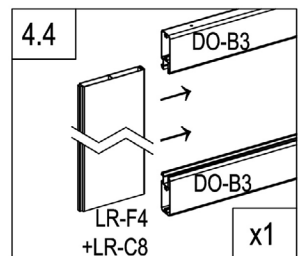
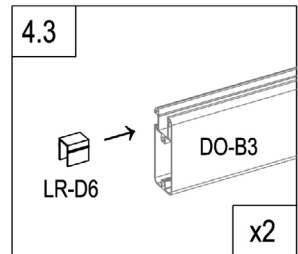
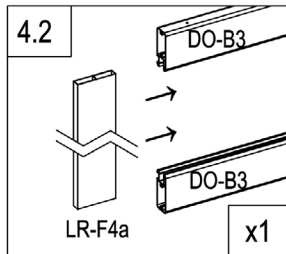
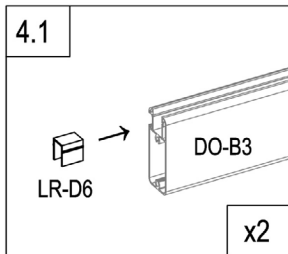
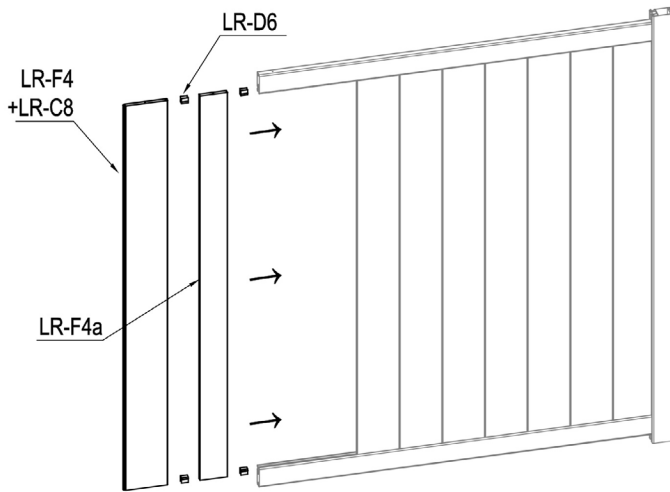

	LR-F4	6
---	-------	---



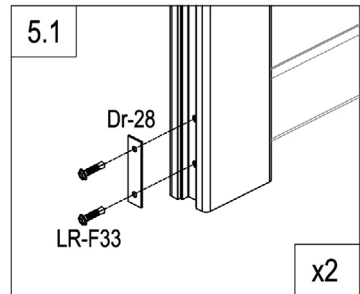
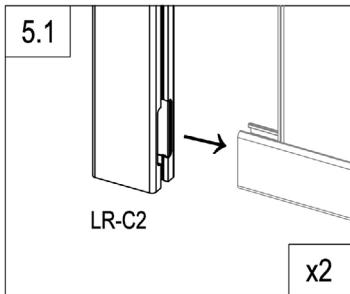
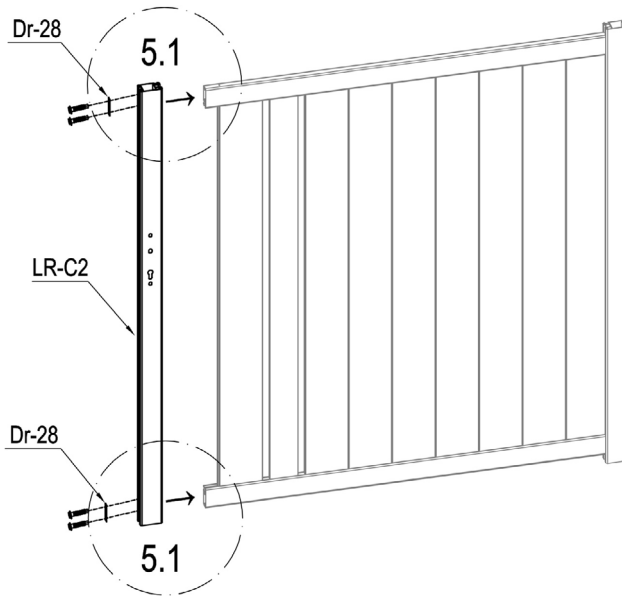

	LR-F4a	1
	LR-D6	4

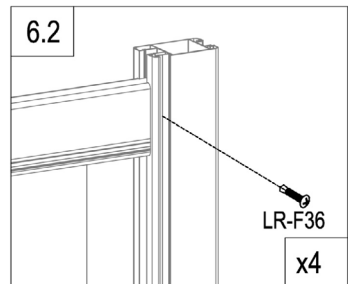
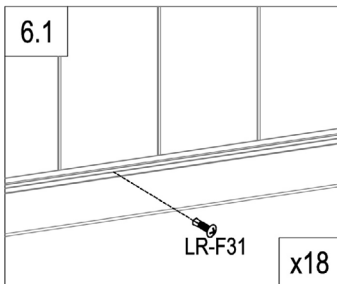
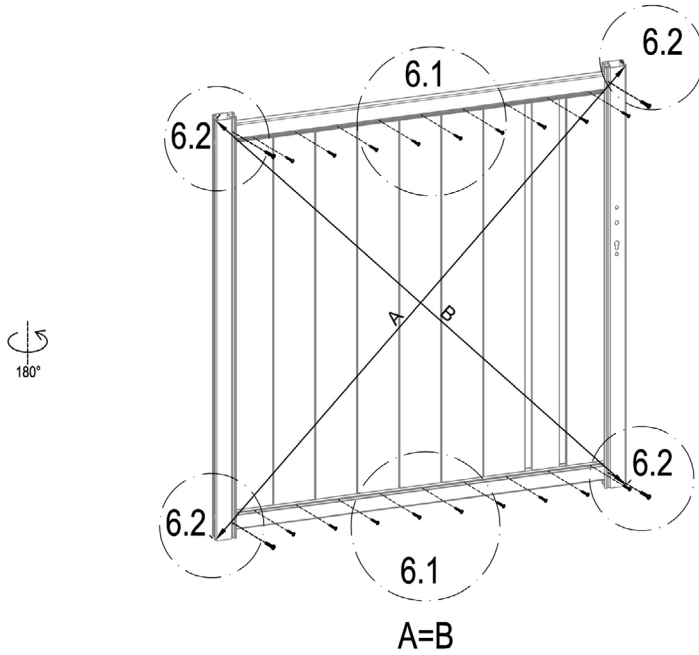

	LR-C2	1
	Dr-28	2
	LR-F33	4



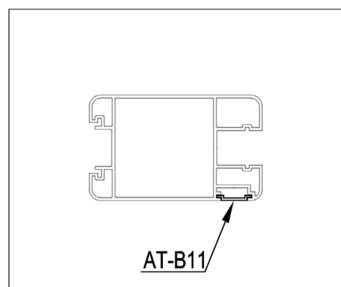
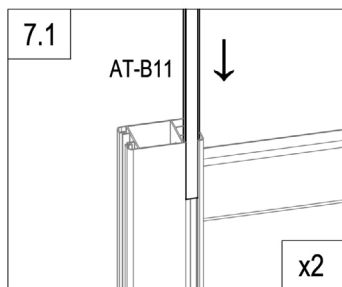
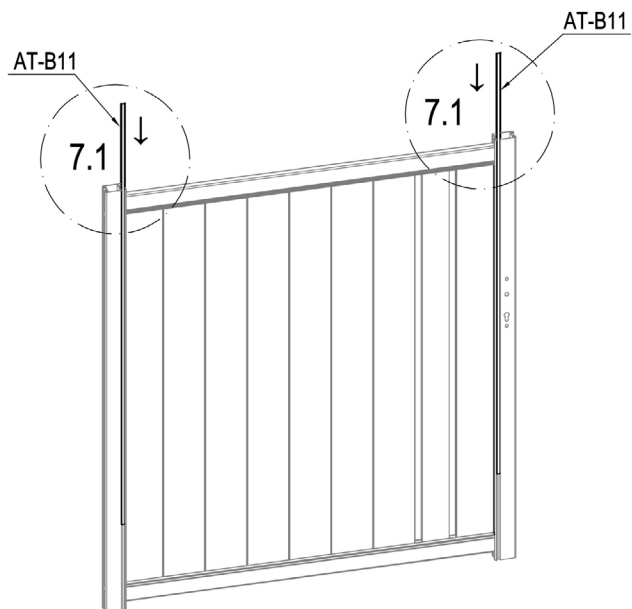

	LR-F31	18
	LR-F36	4

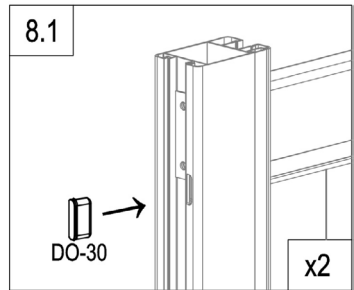
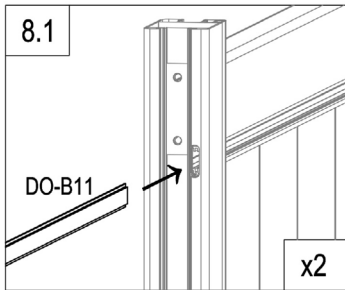
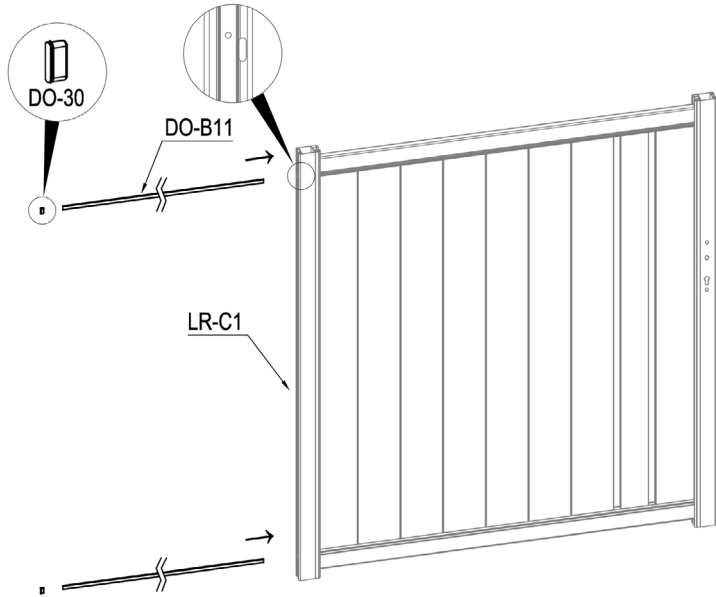

	AT-B11	2
---	--------	---



	DO-B11	2
	DO-30	2

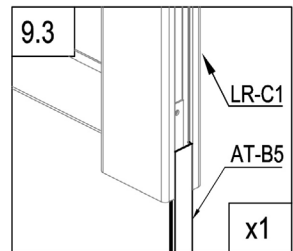
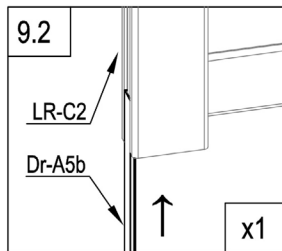
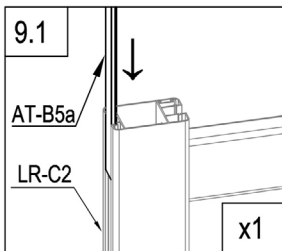
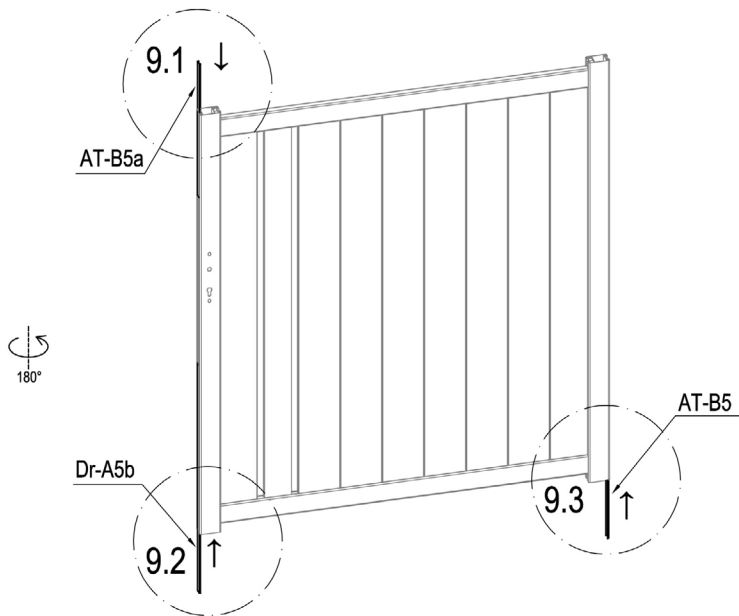

	AT-B5	1
	AT-B5a	1
	Dr-A5b	1

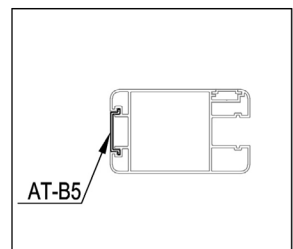

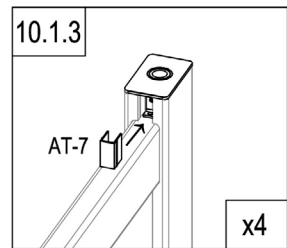
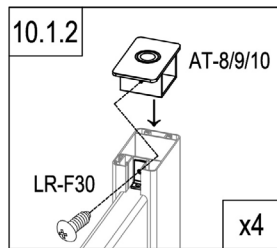
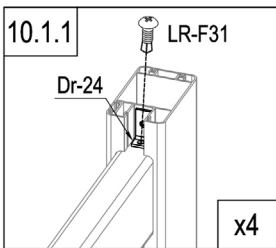
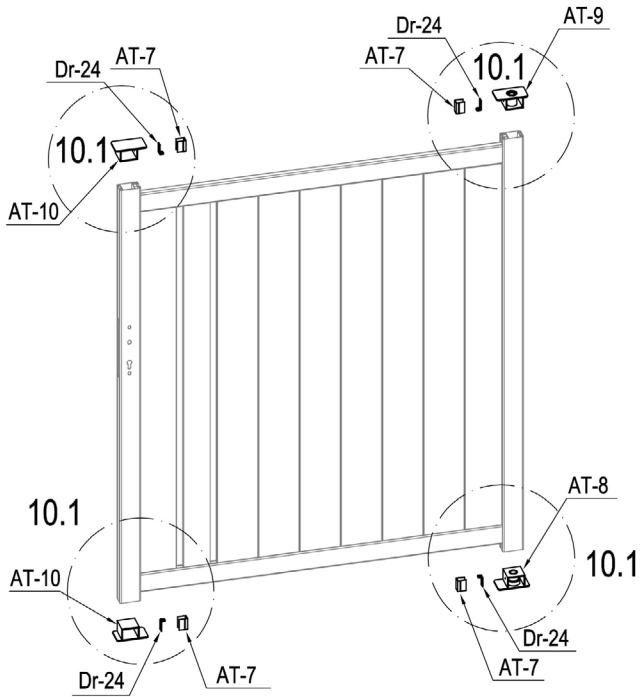

	AT-8	1
	AT-9	1
	AT-10	2
	Dr-24	4



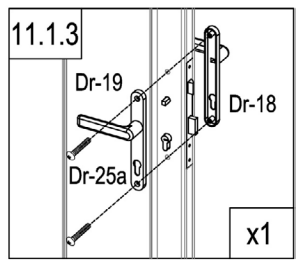
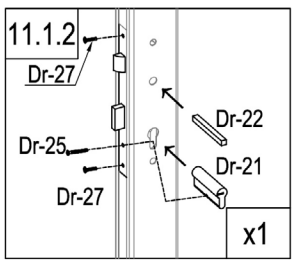
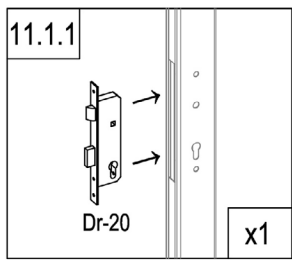
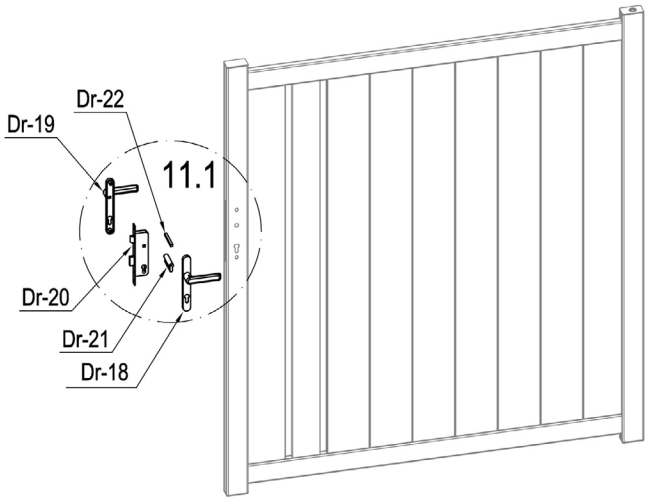

	AT-7	4
	LR-F30	4
	LR-F31	4

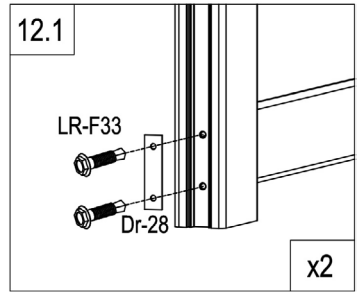
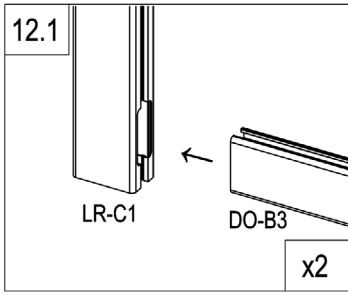
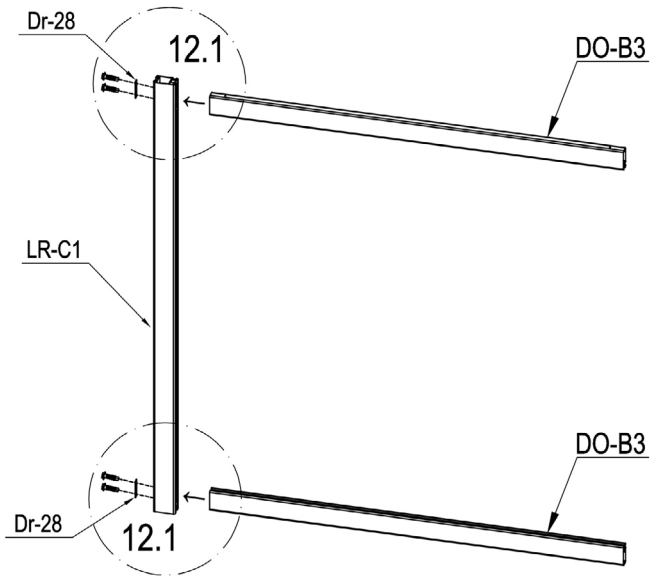

	Dr-20	1
	Dr-21	1
	Dr-22	1
	Dr-25	1

	Dr-18	1
	Dr-19	1
	Dr-25a	2
	Dr-27	2



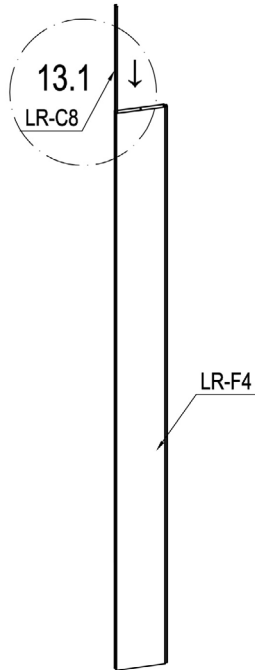

	LR-C1	1
	DO-B3	2
	Dr-28	2
	LR-F33	4

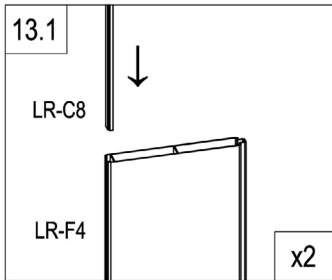

x2



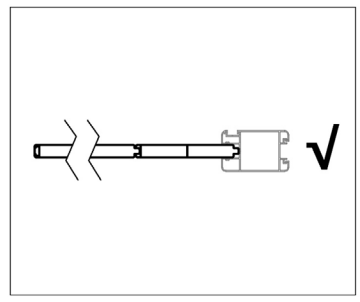
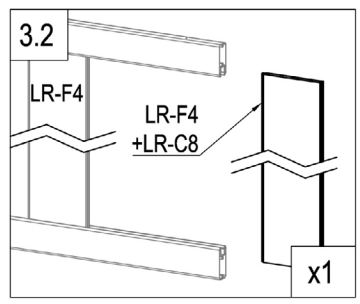
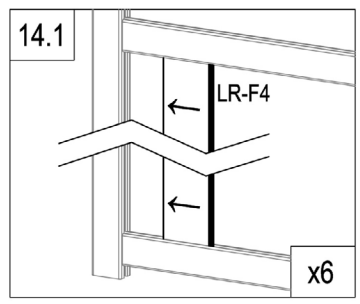
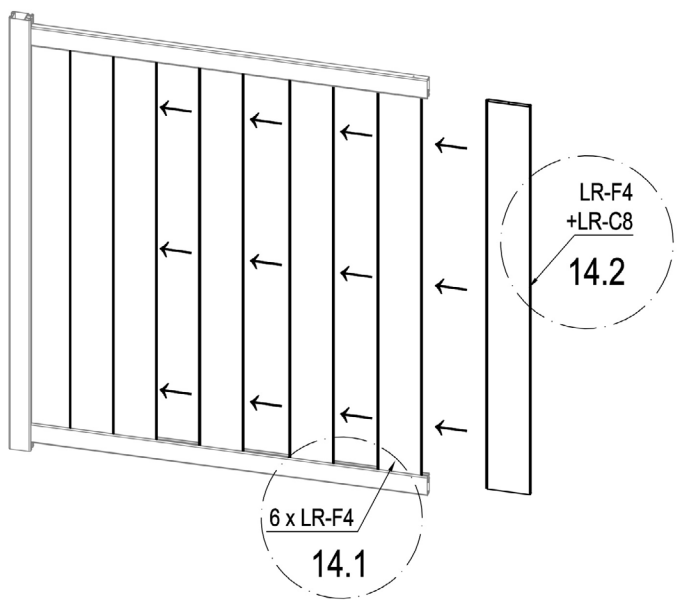

	LR-C8	2
	LR-F4	2



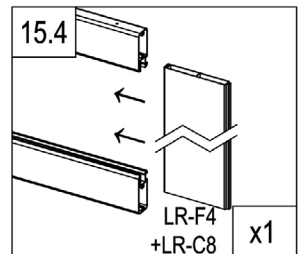
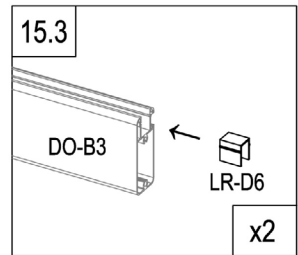
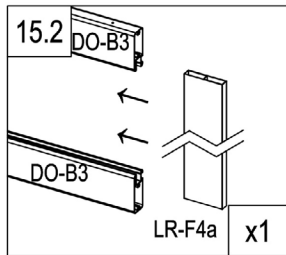
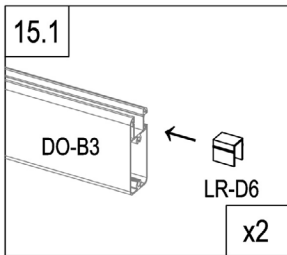
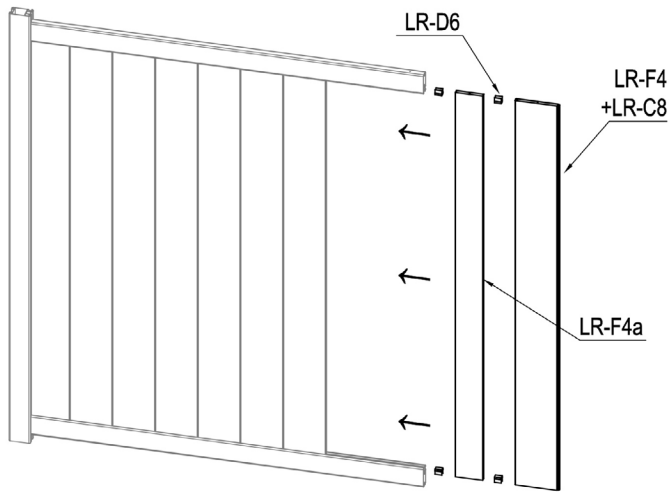

	LR-F4	6
---	-------	---



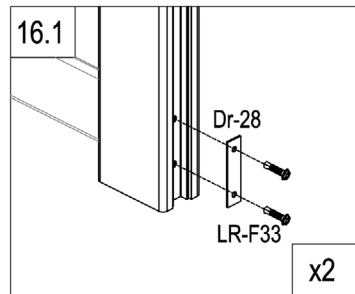
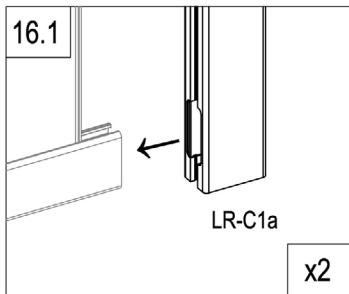
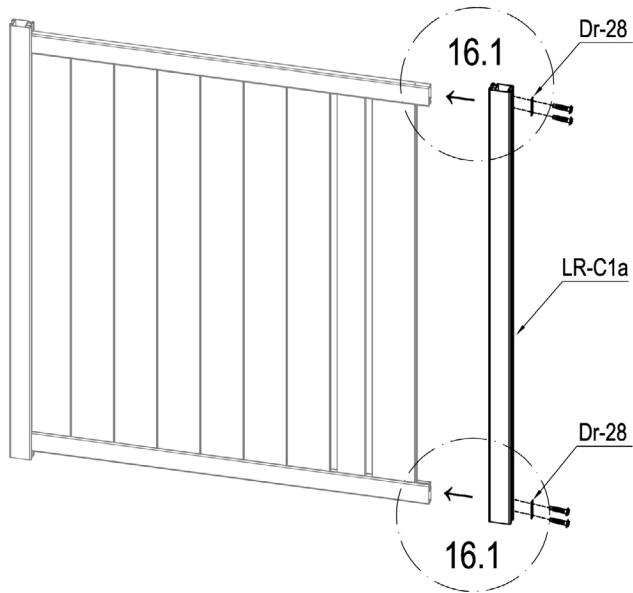

	LR-F4a	1
	LR-D6	4

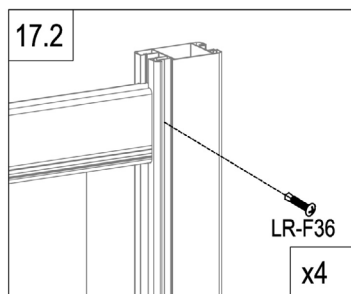
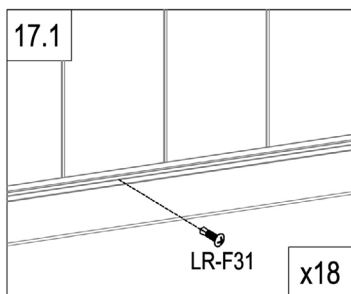
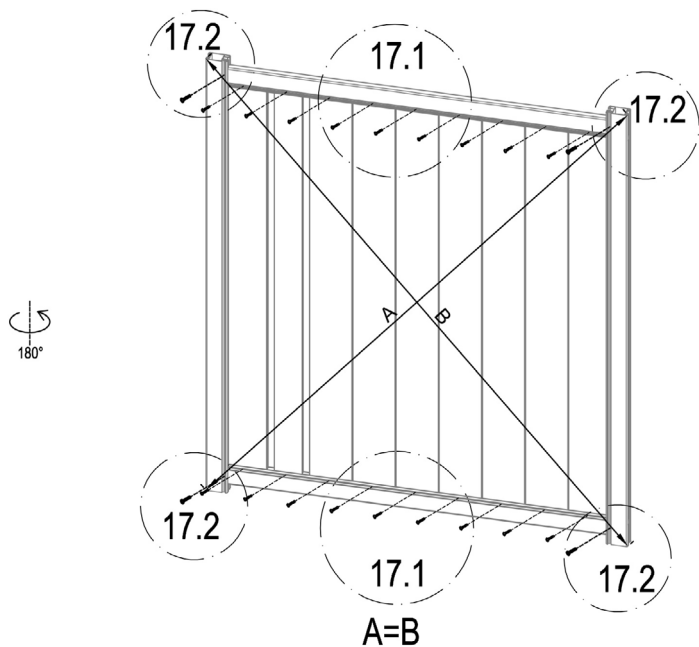

	LR-C1a	1
	Dr-28	2
	LR-F33	4



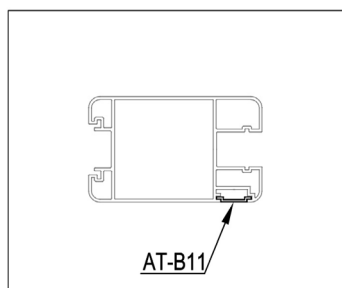
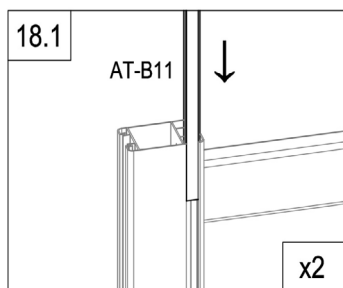
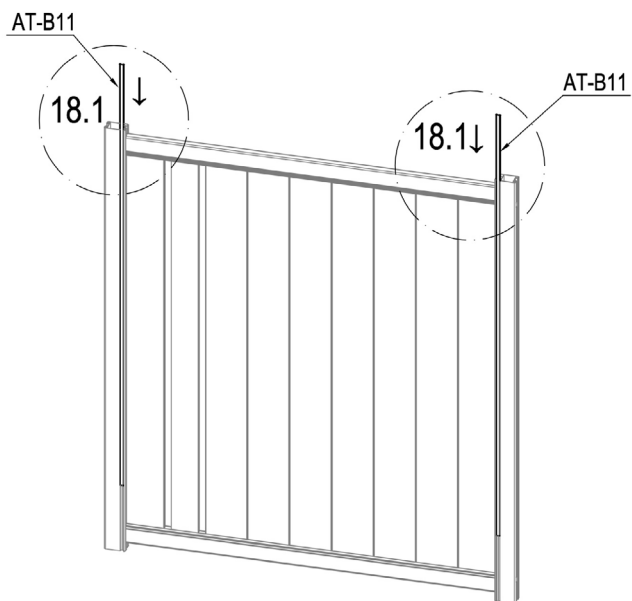

	LR-F31	18
	LR-F36	4



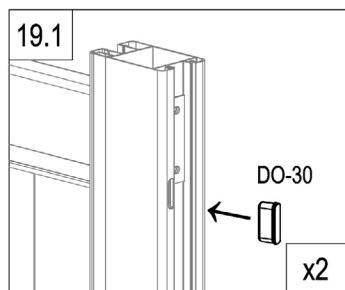
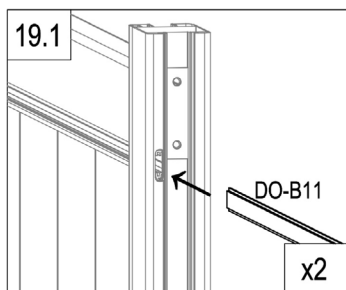
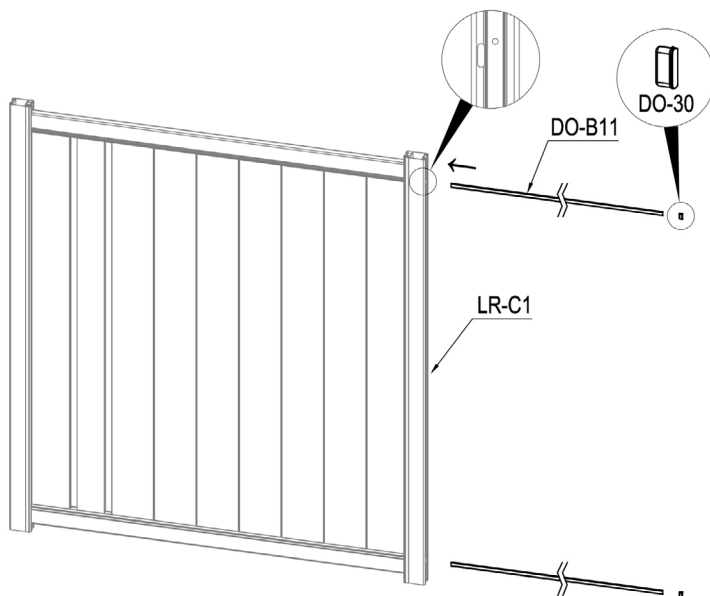

	AT-B11	2
---	--------	---

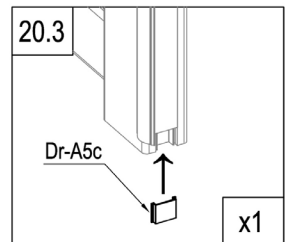
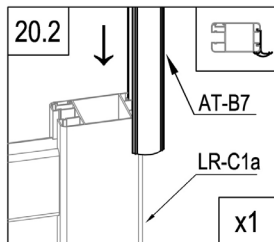
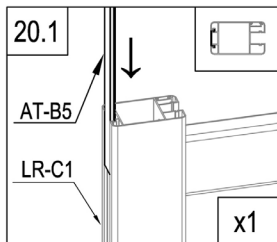
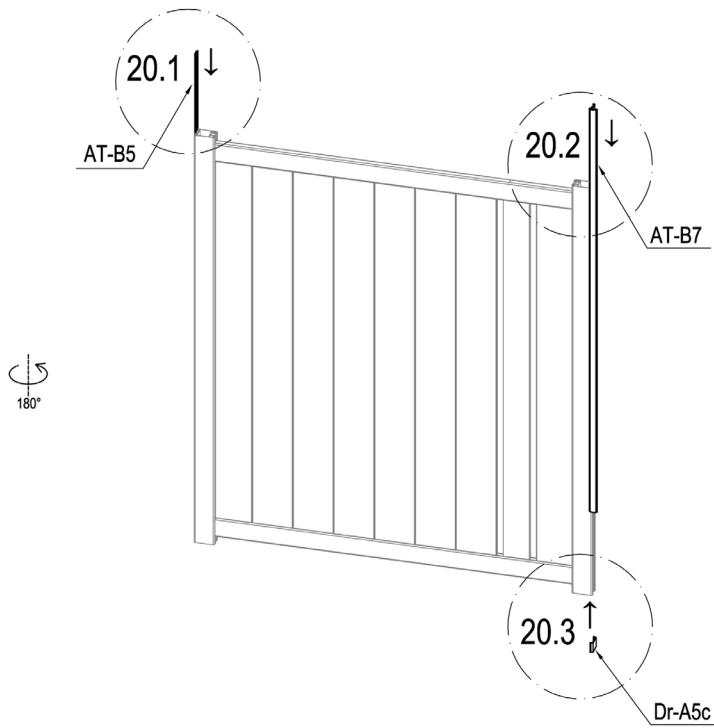

	DO-B11	2
	DO-30	2



	AT-B5	1
	Dr-A5c	1
	AT-B7	1

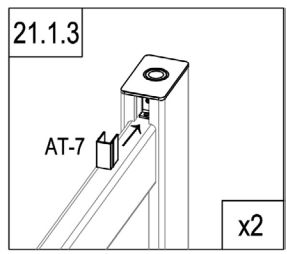
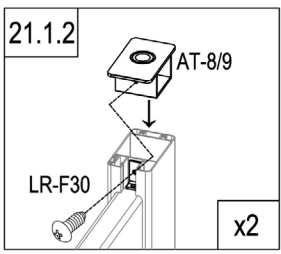
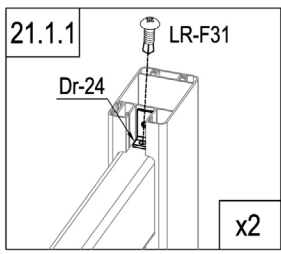
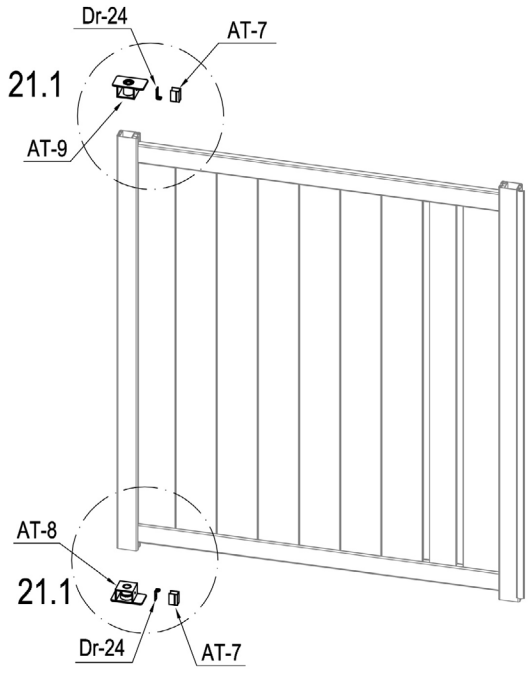

	AT-8	1
	AT-9	1
	Dr-24	2

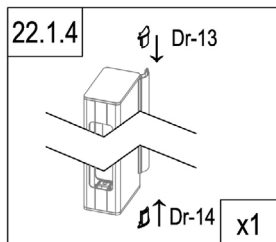
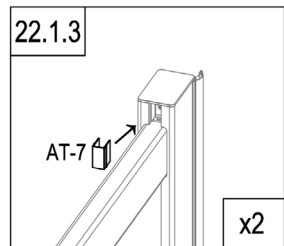
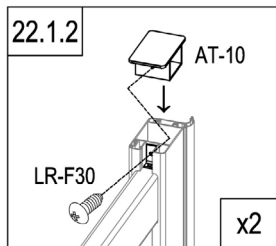
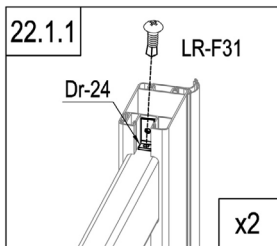
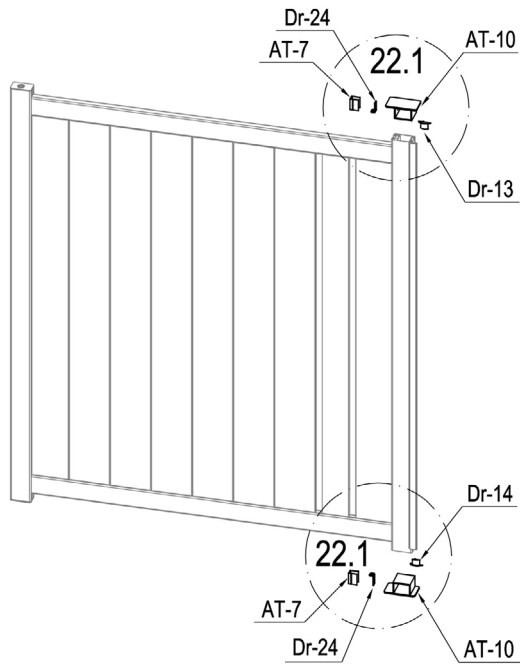

	AT-7	2
	LR-F30	2
	LR-F31	2

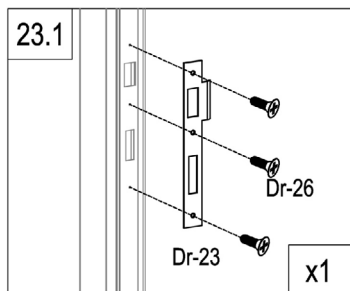
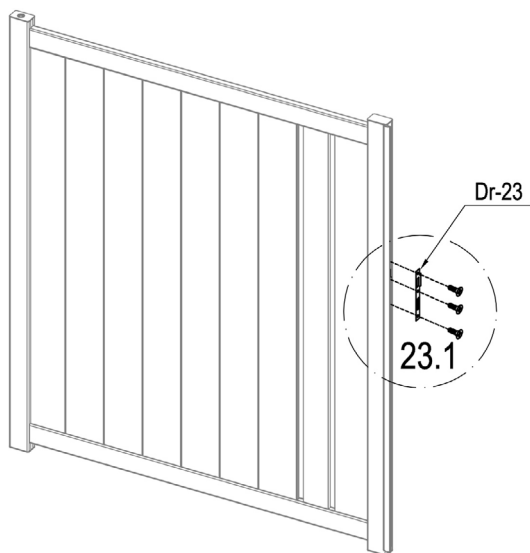

	AT-10	2
	Dr-24	2
	AT-7	2
	Dr-13	1

	Dr-14	1
	LR-F30	2
	LR-F31	2



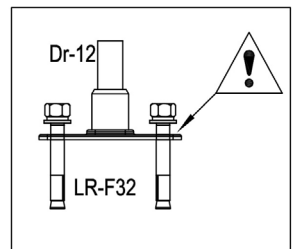
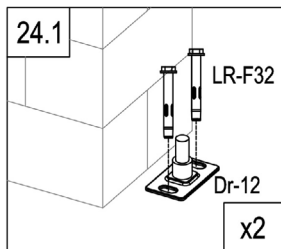
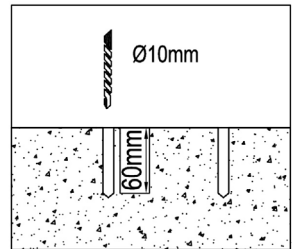
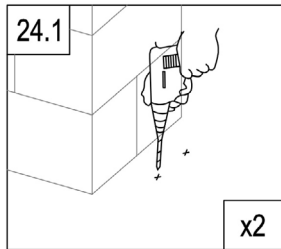
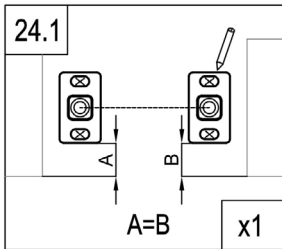
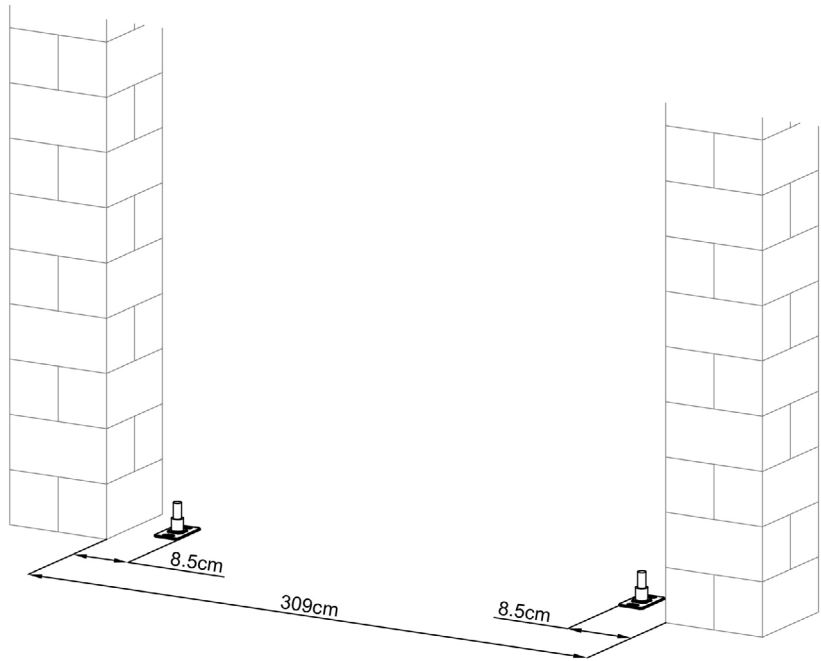

	Dr-23	1
	Dr-26	3



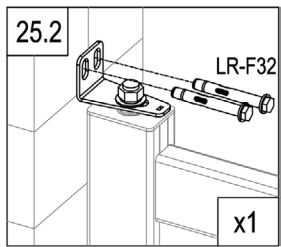
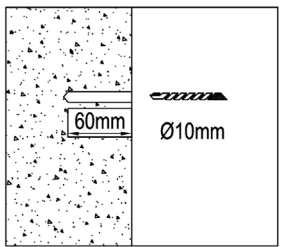
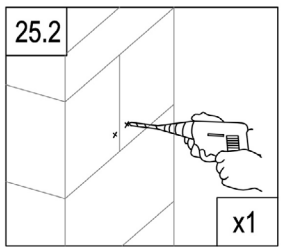
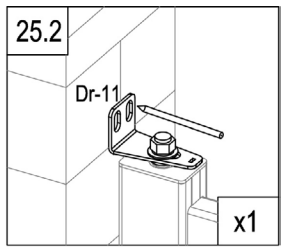
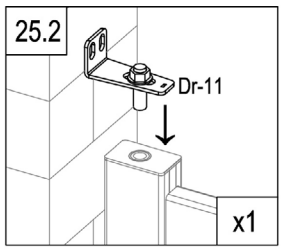
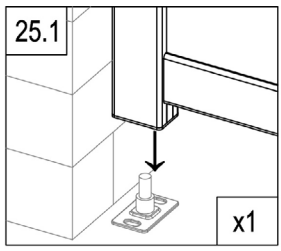
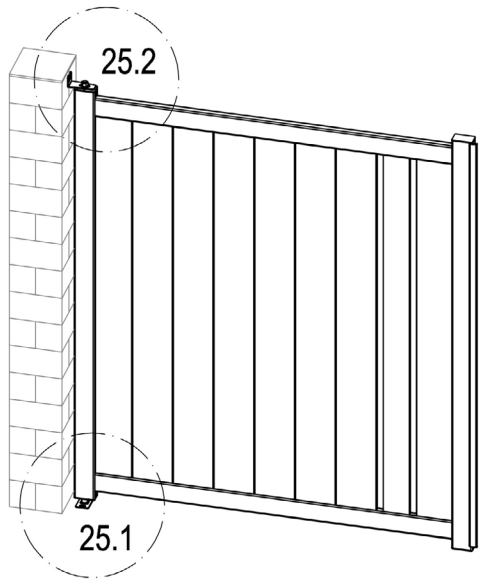

	Dr-12	2
	LR-F32	4

CASANOVO



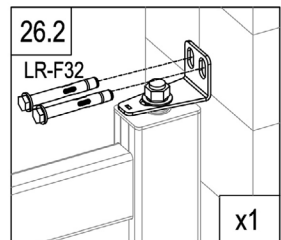
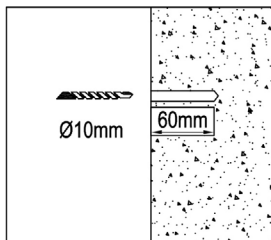
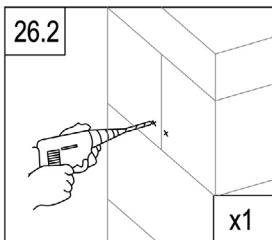
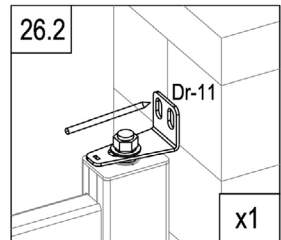
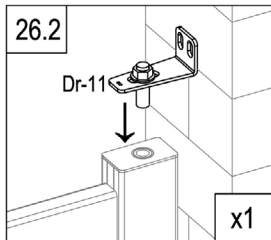
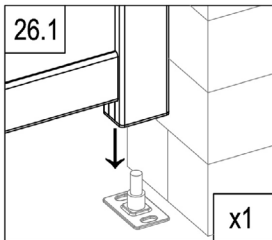
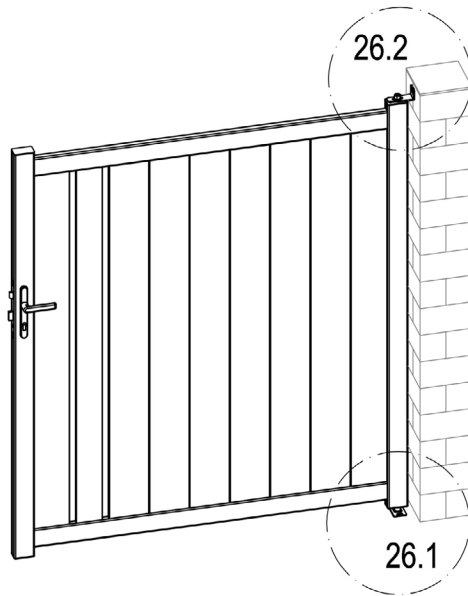

	Dr-11	1
	LR-F32	2



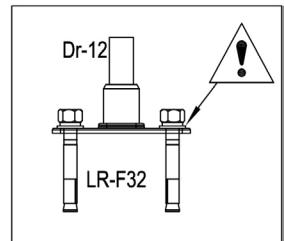
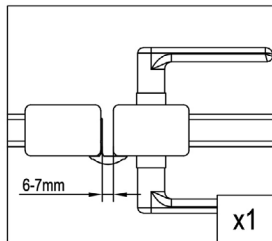
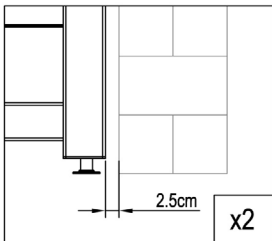
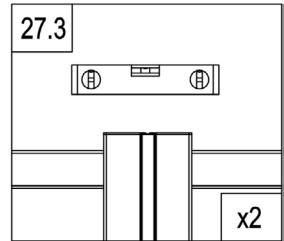
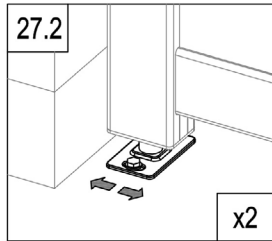
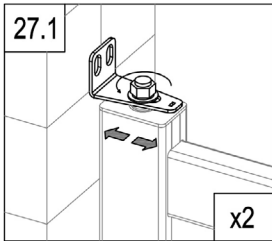
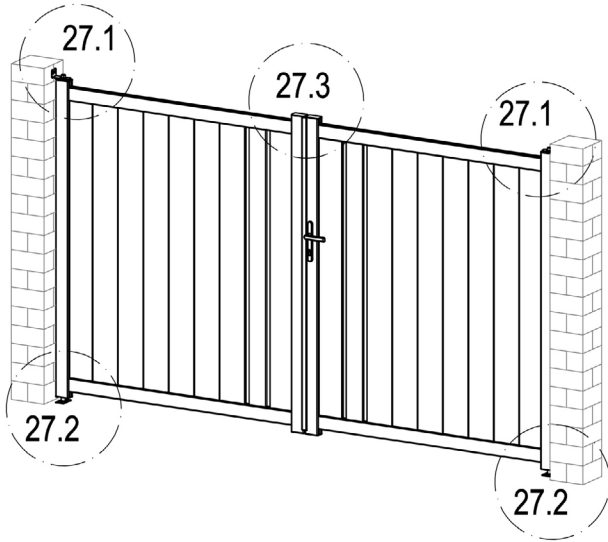
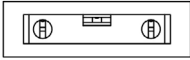

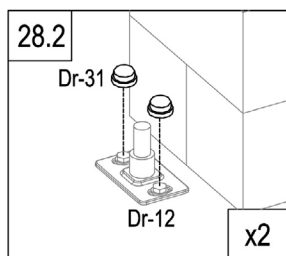
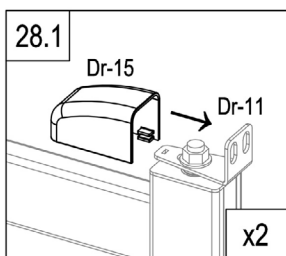
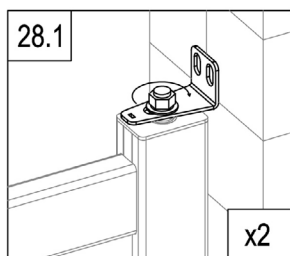
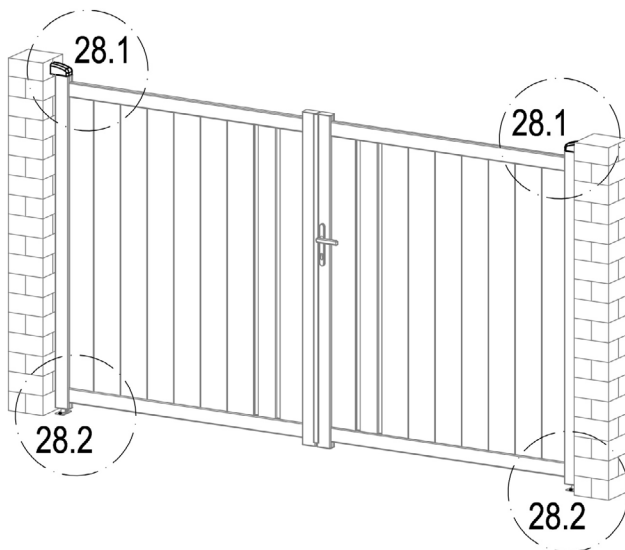

	Dr-11	1
	LR-F32	2



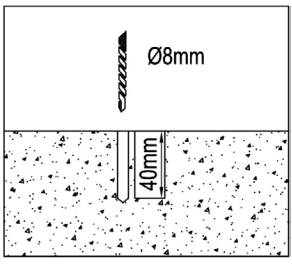
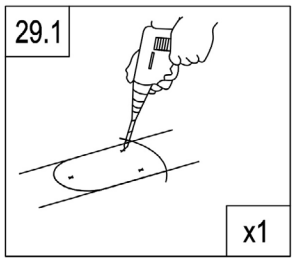
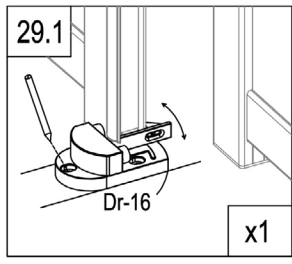
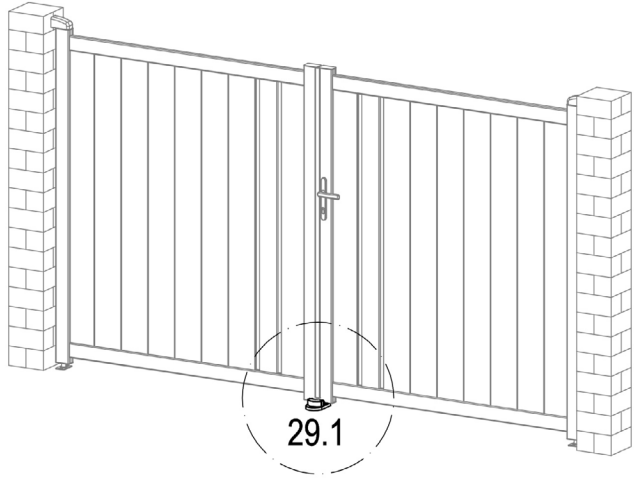



	Dr-15	2
	Dr-31	4

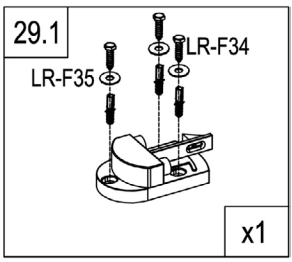

	Dr-16	1
	LR-F34	3
	LR-F35	3

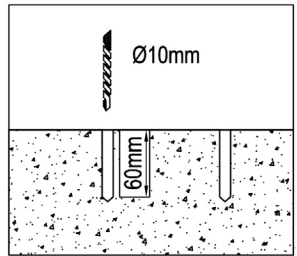
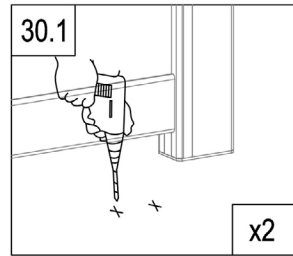
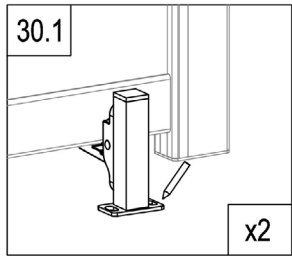
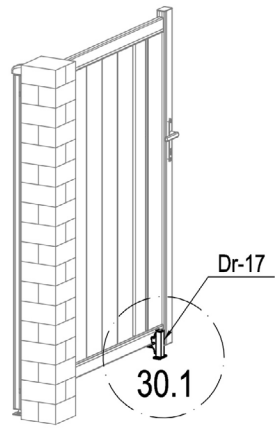
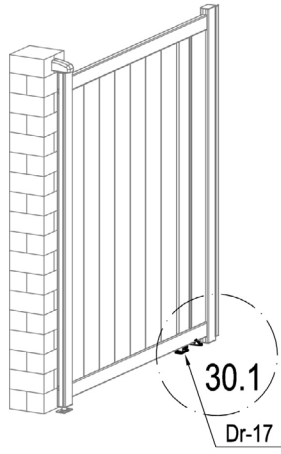



	LR-F32	4
	Dr-17	2

