

**FIRE PIT - FP3019-20**  
**OWNER'S MANUAL**

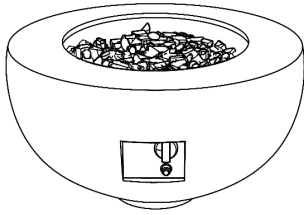

**Warning: For Outdoor use only!**

**Not for domestic use!**

**Keep the instruction for future reference!**

**Read the instructions before installation and use!**

**WARNING:**  
 -Do not modify the appliance  
 -Do not move the appliance during use  
 -Turn off the gas supply at the gas container after use  
 -Accessible parts may be very hot. Keep young children away  
 -The appliance should not be used in basements or below ground level.  
 -The appliance must only be used for space heating.

**WARNING:**  
 THIS APPLIANCE HAS A NAKED FLAME; A SUITABLE GUARD SHOULD BE USED FOR THE PROTECTION OF YOUNG CHILDREN & THE ELDERLY.

	<b>CARBON MONOXIDE HAZARD</b>
	<p>This appliance can produce carbon monoxide which has no odour.</p> <p>Using it in an enclosed space can kill you.</p> <p>Never use this appliance in an enclosed space such as a camper, tent, car or home.</p>

**INDEX**

Specification	Page 3
Gas Fire pit Safety Warnings	Page 4
Liquid propane gas warnings	Page 7
Expanded View	Page 9
Installation	Page 10
Set up	Page 11
Connecting gas circuit to LPG cylinder	Page 12
Operating Instructions	Page 13
Leakage Testing	Page 14
Maintenance and Cleaning	Page 15
Storage (after use)	Page 16
Troubleshooting	Page 17

**SPECIFICATION**

Product Name	Fire pit		
Model No.	FP3019-20		
Gas Type	LPG gas mixture	Butane at (28-30)mbar/ Propane at 37mbar	LPG gas mixture
Gas Category	I <sub>3B(P)30</sub>	I <sub>3</sub>	I <sub>3B(P)50</sub>
Pn (mbar)	28-30	28-30/37	50
Nominal heat input (Hs)	12 kW		
Gas consumption	G30/872g/h)	G30/872 g/h G31/857g/h	G30/872g/h)
Injector diameter (Ø) and No.	1.7 mm x 1	1.7 mm x 1	1.5 mm x 1
Destination countries	LU, NL, DK, FI, SE, CY, CZ, EE, LT, MT, SK, SI, BG, IS, NO, TR, HR, RO, IT, HU	BE, FR, IT, LU, IE, GB, GR, PT, ES, CY, CZ, LT, SK, CH, SI	DE, AT, CH, SK
Gas regulator	Certified regulator according to EN 12864 (flow rate: max. 1.5kg/h)		
Gas hose	Certified gas hose according to applicable EN-standard (max1.5m)		
Gas cylinder	Standard gas cylinder (recommend to use 4.5kg ~ 15kg)		
Primary air regulation	Fix - not adjustable		
Appliance mass:	50 kg		

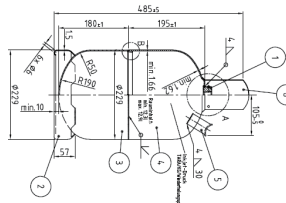

This symbol is stuck on in the higher part of the appliance (do not remove it).

**Attention:**  
**Surface very hot!**  
**Do not touch!!!!**



**ATTENTION:** This appliance is fitted with flexible gas rubber pipe and clamps that must be used; never use different kind and always according to the National Rules in force of the country of destination. These components should be periodically substituted, according to the date reported on the body of each of them, or according to the National Rules in force of the country of destination. LPG cylinder are not included and have to be bought according to LPG compartment shape and cylinder support.

**GAS FIREPIT SAFETY WARNINGS**

**WARNING:**  
 Failure to heed the Dangers, Warnings and cautions contained in this Owner's Manual may result in a serious explosion causing damage to property, bodily injury.

**& WARNINGS FOR YOUR SAFETY**

**GENERAL WARNINGS**  
**FOR OUTDOOR USE ONLY--DO NOT OR STAND ON TABLE**  
**Warning - For your safety**

- If the information in this manual is not followed exactly, a fire or explosion may result, causing property damage, personal injury or loss of life.
- **IMPORTANT NOTICE:** read and understand all warnings and precautions prior to assembly and use for your gas fireplace.
- **DANGER: Failure to follow the dangers, warning and cautions in this manual may cause a fire or explosion causing damage to property, serious bodily injury or death.**
- Minimum Clearance From Unit To Combustible Material:  
**72" (182.9cm) from the top; 36" (91.5cm) from all sides and back.**  
 Do not locate this appliance under over-head unprotected combustible surfaces.  
**IF YOU SMELL GAS:**
  1. Shut off gas supply to the fireplace
  2. Extinguish any open flame
  3. Do not try lighting any appliance
  4. Do not touch any electrical switch nor use any phone in your building
  5. Immediately call your gas supplier from a neighbour's phone
  6. Follow the gas supplier's instructions
  7. If you cannot reach your gas supplier, call the fire department
- Improper installation, adjustment, alteration, service or maintenance can cause injury or property damage. Read the installation, operation and maintenance instructions thoroughly before installing or servicing this equipment.
- Keep these instructions for future reference. If you are assembling this unit for someone else, give this manual to him or her to read and keep for future reference.
- This gas fireplace should ONLY be used outdoors in a well-ventilated space and should NOT be used inside a building, garage, or any other enclosed area.
- Do NOT use this outdoor gas fireplace for indoor heating. TOXIC carbon monoxide fumes can accumulate and cause asphyxiation.
- Never LEAVE this gas fireplace unattended when in use.
- Children and adults should be alerted to the hazards of high surface temperatures and kept at a safe distance

- while fireplace is in use.
- Do NOT operate light or use this fireplace within 8 feet of walls, structures or buildings.
- Storage of this fireplace indoors is permissible only if it has been disconnected from its fuel supply (LP gas cylinder).
- Gloves are strictly recommended to be used while moving this appliance, to protect your hands.
- Any sealed parts by Manufacturer or his agent cannot be altered by the user
- Do not store or use gasoline or other flammable vapors and liquids within 25 feet (7,62m) of this or any other appliance.
- Do NOT store any combustible materials in the base enclosure.
- The use of alcohol, prescription or non-prescription drugs may impair an individual's ability to properly assemble or safely operate this fireplace.
- Do not use in an explosive atmosphere. Keep gas fireplace area clear and free from combustible materials, gasoline and other flammable vapors and liquids.
- This outdoor fireplace is NOT to be operated by children. Young children should be closely supervised when in the vicinity of this outdoor fireplace.
- This outdoor fireplace is not to be installed or used in or on recreation vehicles and/or boats.
- Always use in accordance with all applicable local, state and national codes. Contact your local fire department for details on outdoor fires.
- Use the same precautions you would with any open fire with this outdoor fireplace.
- Do NOT burn solid fuels such as: wood, charcoal briquettes, lump charcoal, manufactured logs, driftwood, trash, leaves, paper, cardboard, plywood, painted or stained or pressure treated wood in this outdoor fireplace.
- Do NOT alter this outdoor fireplace in any manner.
- Do NOT use this outdoor fireplace until it is COMPLETELY assembled and all parts are securely fastened and tightened.
- Do NOT store another LP gas tank within 10 feet (3,05 m) of this outdoor fireplace while it is in operation.
- Do NOT use this outdoor fireplace near automobiles, trucks, vans or recreational vehicles.
- Do NOT use this outdoor fireplace under any overhang or near any unprotected combustible materials. Avoid using near or under overhanging trees and shrubs.
- Always use this outdoor fireplace on a hard, level, non-combustible surface such as a concrete, rock or stone. An asphalt or blacktop surface may not be acceptable for this purpose.
- Do NOT use this outdoor fireplace if any part has been under water. Immediately call a qualified service technician to inspect the fireplace and to replace any part or control system and any gas control which has been under water.
- Do NOT wear flammable or loose clothing when operating this outdoor fireplace.
- Do NOT use in windy conditions.
- Keep all electrical cords away from a hot outdoor fireplace.
- Certain areas of this outdoor fireplace will become too hot to touch during and after use. Do not touch hot surfaces until the unit has cooled unless you are wearing protective gear such as insulated pot holders or heat resistant gloves or mittens to avoid burns.
- Children and adults should be alerted to the hazards of high surface temperatures and should stay away to

5 of 16

- avoid burns or clothing ignition.
- Do NOT hang or place clothing or other flammable materials on or near the gas fireplace.
- Any guard or other protective device removed for servicing the fireplace must be replaced prior to operation.
- Do NOT attempt to move or store this outdoor fireplace until all parts are cool.
- Do NOT lean over this outdoor fireplace when lighting or when in use.
- Use only the regulator and hose assembly provided. Use only replacement regulator and hose assemblies specified by the manufacturer.
- Storage of this outdoor fireplace indoors is permissible only if the tank is disconnected, removed from the outdoor fireplace and properly stored outdoors.
- Do not attempt to disconnect the gas regulator from the tank or any gas fitting while the outdoor fireplace is in use.
- Always shut off gas supply at the tank valve and disconnect regulator from the tank when the fireplace is not in use.
- Do NOT sit on the mantle when the unit is in operation.
- Do not throw anything onto the fire when the unit is in operation.
- Lava rocks are very hot; please keep children or pets away at a safe distance.
- It is essential to keep the outdoor fireplace valve compartment, burners, and circulating air passages clean. Inspect outdoor fireplace for debris before each use.
- Prior to each gas fireplace operation, check the hose for evidence of excessive abrasion or wear by looking through the visual check hole. If the hose is damaged, cut or cracked, it must be replaced before using the gas fireplace. The hose assembly can only be replaced by a hose assembly specified by the manufacturer.
- Before each use, remove the lava rocks. Examine the burner and its components. If dirty, clean with a soft brush and soapy water solution. Also examine the area around the burner. Any dirt or foreign material, such as spider webs or nests in this area should be removed. If it is evident that the burner is damaged, it must be replaced before the gas fireplace is used.
- The burner assembly can only be replaced by a burner specified by the manufacturer. Place the hose out of the pathways where people may trip over it.
- Do NOT cross the hose between outdoor fireplace and the propane tank.
- **WARNING: When the national regulations require it, it's necessary to change the flexible tube.**

6 of 16

## LIQUID PROPANE GAS (LPG) WARNINGS

- LP gas is flammable and hazardous if handled improperly. Please review the characteristics before using any LP gas product.
- Propane Characteristics:
- Flammable, explosive under pressure, heavier than air, and settles in pools in low areas. In its natural state, propane has no odour. For your safety, an odorant is typically added. Contact with propane could burn the skin.
- Propane is extremely flammable and hazardous if handled improperly.
- LP GAS WARNINGS:**
- Cylinders must be stored outdoors in a well-ventilated area out of reach of children.
- Disconnected cylinders must have threaded valve plugs tightly installed and must not be in a building, garage or any other enclosed area.
- Never use a propane cylinder with a damaged body, valve, collar or footing.
- Dented or rusted propane cylinders may be hazardous and should be checked by your propane gas supplier.
- LP gas tank must be arranged for vapour withdrawal.
- The LP gas tank must have a tank collar to protect the tank valve.
- Never use an LP gas tank with a damaged body, valve, collar, or footing. Dented or rusted LP gas tanks may be hazardous and should be checked by your LP gas supplier prior to use.
- The LP gas tank should not be dropped or handled roughly.
- Tanks must be stored outdoors out of the reach of children. Do NOT store in a building, garage, or any other enclosed area.
- Never store your LP gas tank where temperatures can reach over 125°F.
- Do not store the LP gas cylinder in direct sunlight or near a source of heat or combustion.
- Never keep a filled LP gas tank in a hot car or car trunk. Heat will cause the gas pressure to increase, which may open the relief valve and allow gas to escape.
- Place dust cap on valve outlet whenever the LP gas tank is not in use. Only install the type of dust cap on the LP gas tank valve outlet that is provided with the LP gas tank valve. Other types of caps or plugs may result in leakage of propane.
- Do not store a spare LP gas cylinder under or near this appliance.
- Never fill the LP gas cylinder beyond 80% full.
- If the information in (a) and (b) is not followed exactly, a fire causing death or serious injury may occur.
- LP gas cylinders should be filled only by a certified LP gas dealer.
- the pressure regulator is set for 28-30mbar
- Regulator outlet pressure is 28-30mbar
- Never attempt to attach this appliance to the self-contained LP gas system of a camper trailer, motor home or house.

7 of 16

- Always use the pressure regulator and hose assembly provided with the appliance to connect to a LP gas cylinder. Never connect to an unregulated LP gas supply.
- Contact your retailer's customer service department for replacement parts.
- Hand turn the manual gas control valve. Never use tools. If the valve will not turn by hand, do not try to repair it. Call a certified gas technician. The use of force or any self attempted repair may result in a fire or explosion.
- Use only the type of gas and the type of LPG cylinder specified by the manufacturer.
- Appliance is fitted with gas regulator, flexible gas rubber pipe and clamps according to the National Rules in force of the country of destination.
- Appliance must use an approved gas regulator (approved for a working temperature not lower than 50 °C) according to the EN Standard (see minimum, nominal and maximum pressure on page 11 - gas regulator inlet and outlet connection according to the National Rules in force) and flexible gas rubber pipe according to EN 1763-1 (with proper inner diameter according to gas inlet connection and National Rules in force) with a length not over 1,5 m and approved for a working temperature not lower than 60 °C. When substitution will be necessary, you have to purchase suitable gas regulator, flexible gas rubber pipe and clamps from your local gas dealer; gas regulator should be substituted not over 10 years.
- Flexible gas rubber pipe must be carefully maintained, avoiding any twisting. Never use a damaged gas regulator.
- Never connect this appliance to an unregulated LPG source (gas regulator is mandatory to be used).
- When the appliance is not in use, turn the LPG cylinder in "OFF" position.
- Always perform a leakage test on gas connections whenever a LPG cylinder is connected. If bubbles form in Flexible gas rubber pipe must be located in the LPG compartment carefully, avoiding any twisting.
- Never use a damaged gas regulator.
- Always perform a leakage test on gas connections whenever a LPG cylinder is connected. If bubbles form in the leakage test solution, do not use it. Never use a flame to test for leakages. **It is strictly forbidden and dangerous!**

8 of 16

## EXPANDED VIEW

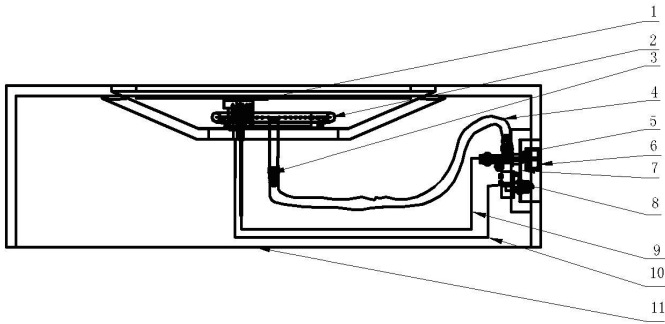

NO.	PART'S NAMES
1	Wind Shelter
2	Burner assembly
3	Orifice
4	Bellows
5	Valve Ass'y
6	Knob
7	Control plate
8	Pulse Igniter
9	Thermocouple
10	Electrode Bar
11	Firepit body

9 of 16

## INSTALLATION

### Packed components list

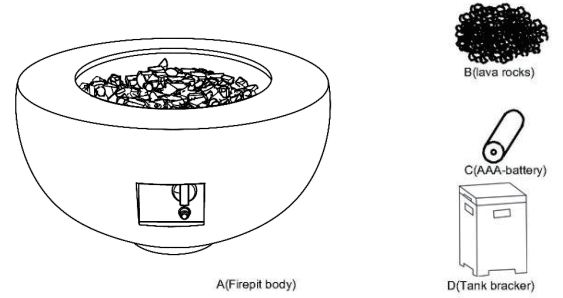

Item	Description	Quantity
A	Fire Pit	1pc
B	Lava rocks	6KG
C	AAA Battery	1pc
D	Tank bracket	1pc

### Set up

- This Gas Fire Pit must be installed on flat, stable surface, away from any combustible materials or construction.
- Remove fire pit from the carton and remove cylinder cargo from another carton, place them on any level, non-combustible surface. (see the picture 1)

10 of 16

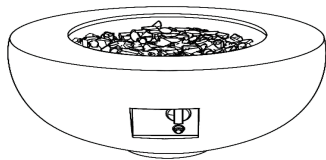

(Picture 1)

- Place the 6KG lava racks on the burner and around the burner evenly. (see the picture 2)

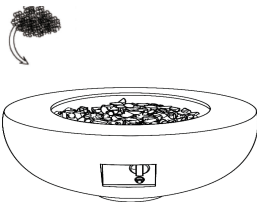

(Picture 2)

- Unscrew the button cap of ignite, put an AAA battery into ignite compartment with anode outward, then screw the button cap (see picture 3)

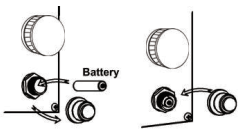

(Picture 3)

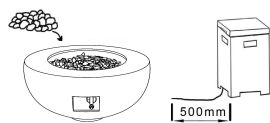

(Picture 4)

- Take down the lid of cylinder cargo carefully and put it in the center of the tank bracket. The bracket is away from the fire-pit body 500mm. (See the picture 4)
- Locate the hose out of the pathways where people may trip over it or in areas where the hose may be subjected to accidental damage.

11 of 16

**CAUTION:** Do not kink flexible gas hose. If it is kinked, a gas leak could occur

### Instruction for connecting gas circuit to LPG cylinder:

Keep at hand suitable crossed screwdriver, adjustable spanners, pliers and wrenches. Before assembly, make sure all protection packing material has been removed. Flexible gas rubber pipe (EN 1763-1) and clamps (if necessary) are supplied with this appliance and must be used, according to National Rules in force. You need to purchase one gas cylinder. The LPG cylinder should be standard one. Recommend to use 4,5kg to 15 kg one. Replacement must be that specified in "Gas Requirements" section of this Instruction Manual. Be careful: do not kink flexible gas rubber pipe of gas circuit. If pipe holder should not be provided, thread of the gas inlet connection will be in line with Standards ISO 7-1 or ISO 228-1, according to National Rules in force of the country of destination.

- Make sure appliance gas knob is turned "OFF" (full disk) before assembling (see below Figure5).
- Put the LPG cylinder inside of the tank bracket and tight the screw (see below Figure6)

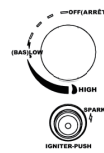

(Picture 5)

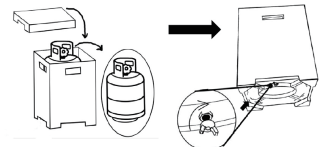

(Picture 6)

- Connect the regulator to LPG cylinder by hand, and Hand tighten only. (see below Figure7)

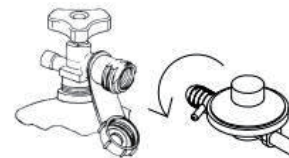

- Connect the hose to the appliance and the regulator. Tighten the screw of the hose clamp with a screwdriver. (see below Figure8)

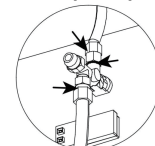

12 of 16

## OPERATING INSTRUCTIONS

### Lighting

Before igniting the appliance, perform "Leakage Testing" in a well ventilated area (outdoor). At first use and after every LPG cylinder substitution, appliance gas circuit must be purged of the inside air before igniting! To do this, turn the control knob counter-clockwise to the ignition position and push it holding for 1 minute before attempting ignition.

- 1 - Make sure that LPG cylinder, full 4/5 its capacity, contains proper LPG Gas (refer to Technical Data on page 2). Turn LPG cylinder valve in full "ON" position and close LPG compartment panel.
- 2 - Make sure that burner control knob is in "OFF" position (full disk).

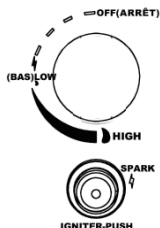

3 - Push the control knob and keep pressing while turning counter-clockwise to the corresponding Maximum position (big flame). At the same time push the ignition button (star). Push the ignition will sparks automatically (it is possible to ignite the appliance even with proper lit long match, approaching carefully the burner managing in the same way).

4 - When the burner is lit in Maximum position (big flame), stop pushing the ignition button (star) and keep the control knob pressed but not for over 20 seconds to heat the thermocouple (FSD); then release it (the first ignition takes generally more time, because the gas circuit is full of air).

5 - If the burner does not keep lit, wait 5 minutes and then repeat steps 3 and 4.

6 - Burner now is lit in Maximum position (big flame).

7 - Adjust the heat input by turning the knob from the Maximum position (big flame), to the Minimum position, as properly.

8 - After lighting, turn knob from Minimum to Maximum (big flame) position and back, to check flame stability.

9 - In case of accidental break down of the flame (for wind or other reasons), FSD will shut-off gas supply automatically (FSD = Flame Safety Device) not for over 60 seconds.

Note: The burner may be noisy when initially turned on.

To eliminate excessive noise from the burner, turn the control knob to the Minimum position and back.

If you experience any ignition problem consult the following "Troubleshooting".

13 of 16

### To turn "OFF" (full disk) the appliance

1. Turn appliance control knob clockwise up to "OFF" position (full disk).
2. Turn the LPG cylinder valve to the "OFF" position.
3. Allow the appliance to cool before moving it (at least 30 minutes).

### Re-Lighting

1. Turn control knob to "OFF" position.
2. Wait at least 5 minutes, to let gas dissipate, before attempting burner re-light.
3. Repeat the "Lighting" steps.

## LEAKAGE TESTING

Never check for gas leakages with a flame or while smoking.

This appliance needs to be periodically checked for leakages and an immediate check is required if the smell of gas is detected.

- Make a soap solution using 1 part of liquid dish-washing soap to 3 parts water. The soap solution can be applied with a soap bottle, brush, or rag to the leakage tested points shown in the figure beside.
- The valve of the LPG cylinder should be in the "OFF" position at this point of the leakage test. Once the soapy solution is applied to the gas connections, the valve of the LPG cylinder needs to be turned to the "ON" position.
- Soap bubbles will begin to form in the soapy solution if any leakage is present.
- In the event of gas leakage, the appliance shall not be used or if alight, the gas supply shall be shut-off and the appliance shall be investigated and rectified before it is used again. Tighten any leaking fittings, then turn on gas supply and recheck.
- If necessary, substitute gasket (according to EN 549 Class B2) or material used to guarantee tightness (according to EN 751-1 Class I).

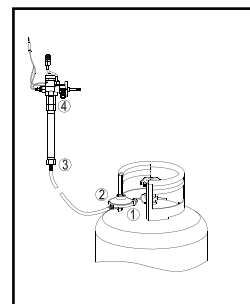

Leakage Test Point ① ② ③ ④

## MAINTENANCE AND CLEANING

To enjoy years of outstanding performance from your appliance, regular services of the appliance is mandatory as follows:

- The appliance should be inspected before use least one time a year by a Qualified Service only. More frequent cleaning may be required according to the use of the appliance.
- Any guard or other protective device removed for servicing the appliance must be replaced before operating it.
- Keep exterior surfaces clean, free and clear from combustible materials.
- Use warm soapy water for cleaning. Never use flammable or corrosive cleaning agents.
- While washing your unit makes sure to keep the area around the burner assembly dry at all times. If the gas

14 of 16

control is exposed to water in any way, **DO NOT** try to use it. **It must be replaced.**

- Burner and LPG compartment circulating air passageways of the appliance must be kept clean.
- Airflow must be unobstructed. Keep controls, burner and circulation air passageways clean. Signs of possible blockage include:
  - Gas odour with extreme yellow tipping of flame / Appliance glow is excessively uneven / Appliance makes popping noises.
  - Spiders and insects can nest in burner or orifices. This dangerous condition can damage the appliance and render it unsafe for use. Clean burner holes by using a heavy-duty pipe cleaner. Compressed air may help clear away smaller particles.
  - Carbon deposits may create a fire hazard. If any carbon deposits develop, clean dome and engine with warm soapy water.
  - After the burner and lava rocks are completely cooled down, remove it from the bowl and use a soft brush to get rid of the mild stains, loose dirt and soil. Wipe with a soft cloth.
  - Clean the bowl and afterward put lava rocks again in proper position.
  - For proper cleaning, a vacuum cleaner can be used.

**Note: In a salt-air environment (such as near the sea), corrosion occurs more quickly than normal.**

**Frequently check the corroded areas and repair them promptly. Stubborn stains, discolouration and possibly rust pitting can occur from exposure to harsh outdoor conditions. Be careful not let any powder or solvent come in contact with painted or plastic components as damage may occur.**

**After long use, some discolouration can come up and it screen is normal.**

Make sure both gas supplies are in the OFF position before changing battery. Please refer to the process of assembling battery.

Please contact the Manufacturer or dealer for information regarding replacement hoses, thermocouples, igniters, lava rocks, etc.

**Attention: Never use unauthorised parts or component for this appliance.**

**Use only original equipment replacement spare parts and components.**

**Otherwise may void the warranty of this product and result in a hazardous condition.**

## STORAGE (after use)

Turn control knob in "OFF" position (full disk).

Turn LPG cylinder in "OFF" position.

Store the appliance in a cool dry place away from direct sunlight; store it upright in an area sheltered from direct contact with inclement weather (such as rain, sleet, hail, snow, dust and debris).

If desired, cover to protect exterior surfaces and to prevent build up in air passages.

**Note: Wait until appliance is cool before covering.**

**During periods of extended inactivity or when transporting:**

Turn control knob in "OFF" position (full disk).

15 of 16

Disconnect LPG cylinder and move to a secure, well ventilated location outdoors. DO NOT store in a location that will exceed 50 °C.

Store appliance upright in an area sheltered from direct contact with inclement weather (such as rain, sleet, hail, snow, dust and debris).

If desired, cover appliance to protect exterior surfaces and to prevent build up in air passages.

**Note: Wait until appliance is cool before covering.**

## TROUBLESHOOTING

Problem:	Condition:	Solution suggested:
Burner won't light	Control knob is not in Maximum position (big flame).	Turn control knob in maximum position (big flame).
	LPG cylinder valve is closed / empty.	Open the valve / replace LPG cylinder with a new one.
	Blockage in the injector.	Clean or replace injector.
	Air in the gas circuit.	Open gas line and bleed it (pressing control knob in) not for over 1 minute or until you smell gas.
	Low gas pressure.	Replace LPG cylinder with a new one.
Burner won't stay lit	Igniter fails.	Use match to light burner, change battery or obtain new igniter and replace it.
	Dirty build up around burner.	Clean dirty around the burner.
	Low flames or not full running around the burner.	Flame spreader holes partially closed; clean the burner.
Burner flame is low	Thermocouple is not operating correctly.	Replace thermocouple (FSD).
	Low Gas pressure.	Replace LPG cylinder with a new one.
	Outdoor temperature is greater than 5 °C and LPG cylinder is less than 25 % full.	Replace LPG cylinder with a new one.
Carbon build-up	Gas pipe is bent or kinked.	Straighten hose and perform leakage test on gas pipe.
	Control knob is fully Maximum position (big flame).	Turn control knob to "OFF" position (full disk), let cool to room temperature and check burner and orifices for blockage.
Flash back (flame inside burner)	Dirty or film on burner.	Clean burner.
Thick black smoke	Burner ports are blocked.	Switch OFF the appliance. Close LPG cylinder valve. Wait 2 minutes, following the ignition procedure. Ignite burner. If problem continuous, switch-off. Contact your dealer.
	Blockage in the burner.	Turn control knob to "OFF" position, let the appliance to cool at room temperature and remove blockage and clean burner inside and outside.

**If you cannot solve trouble according to one of the mentioned solutions, please contact your dealer or Distributor Responsible.**

16 of 16