

CASANOVO

EIGER 300B115

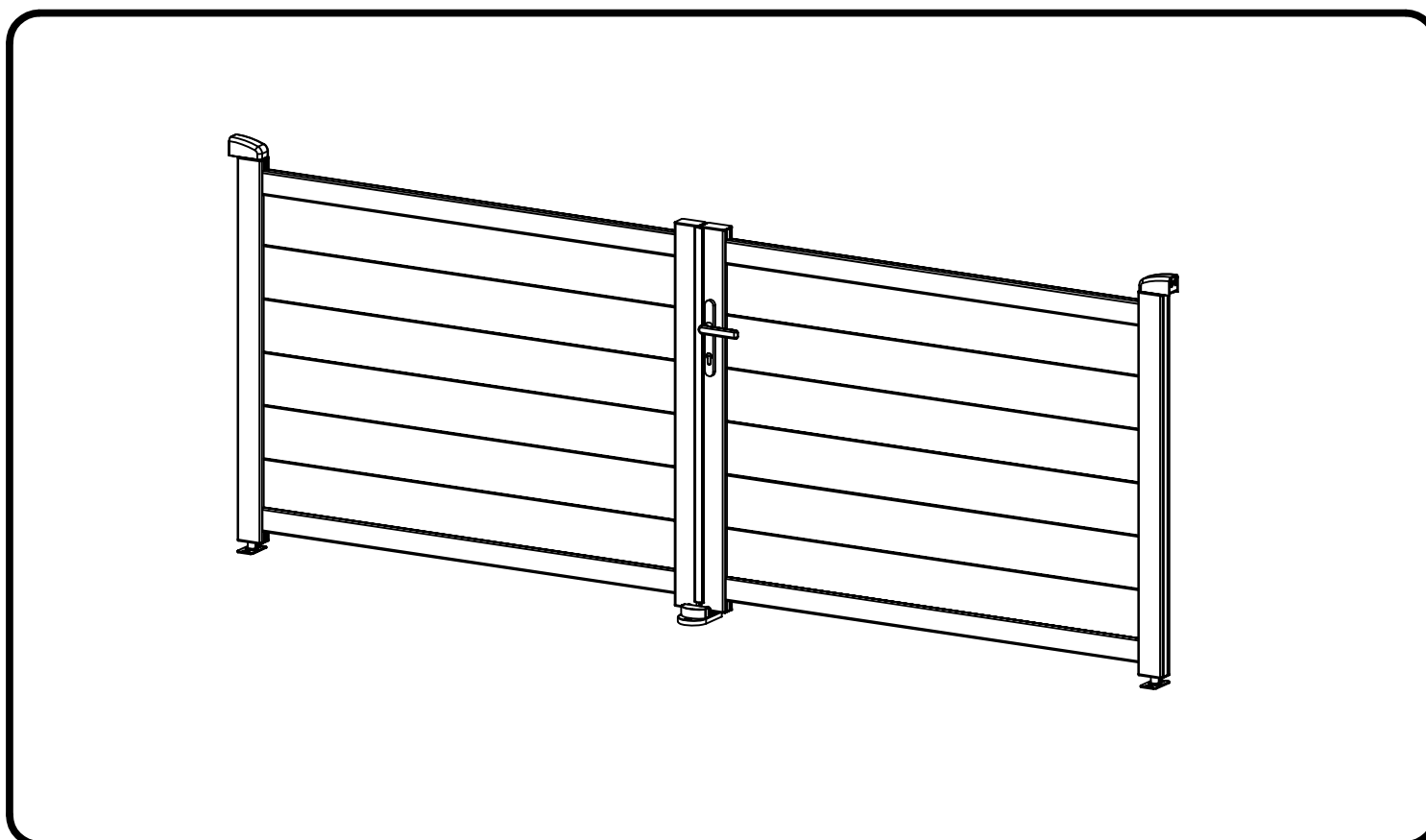

6-7H



x2

COM-000220

[x1]

COM-000221

[x1]

FR

EN

ES

DE

IT

NL

PL



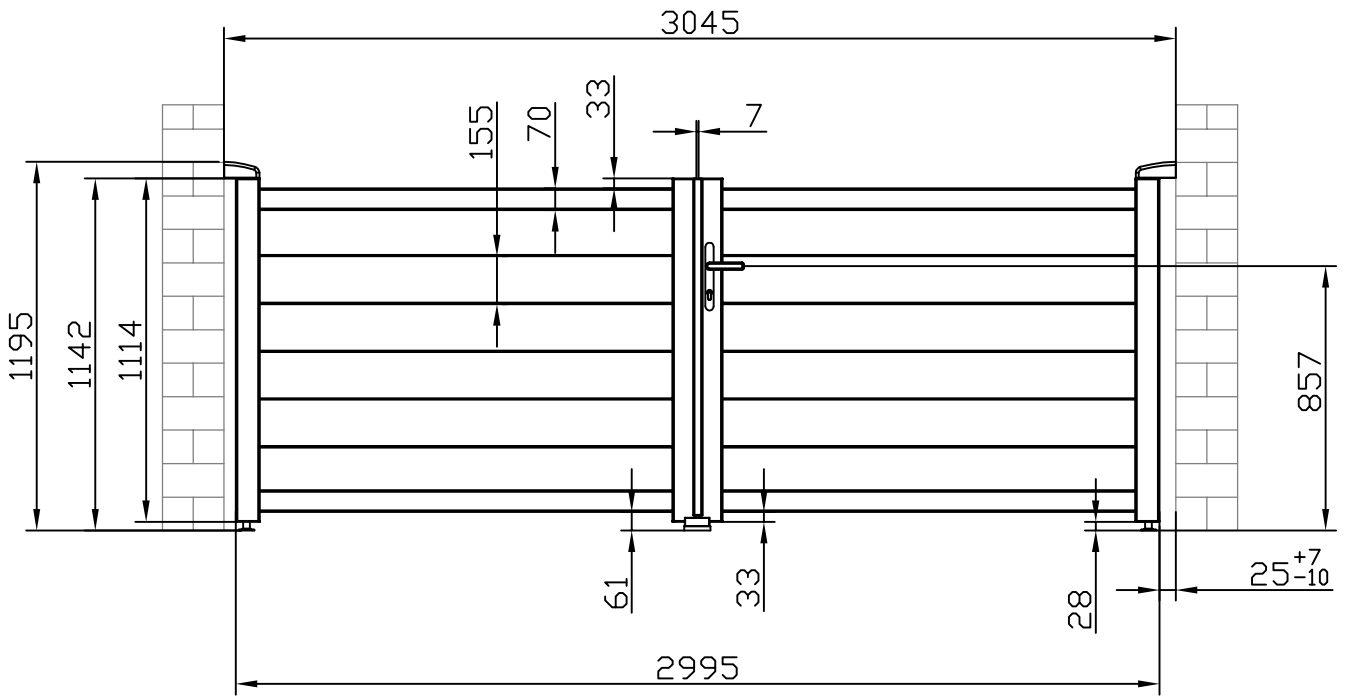

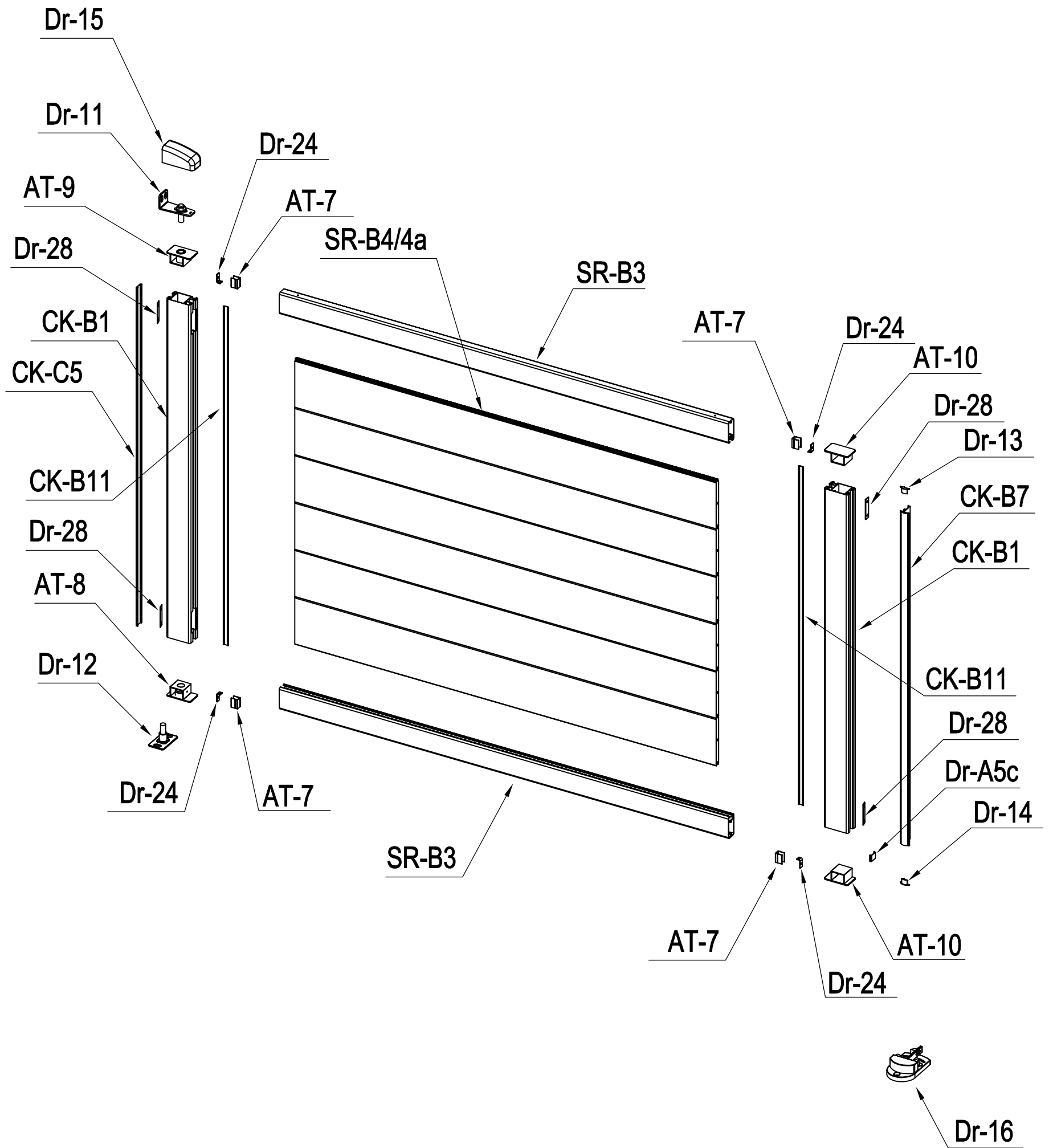

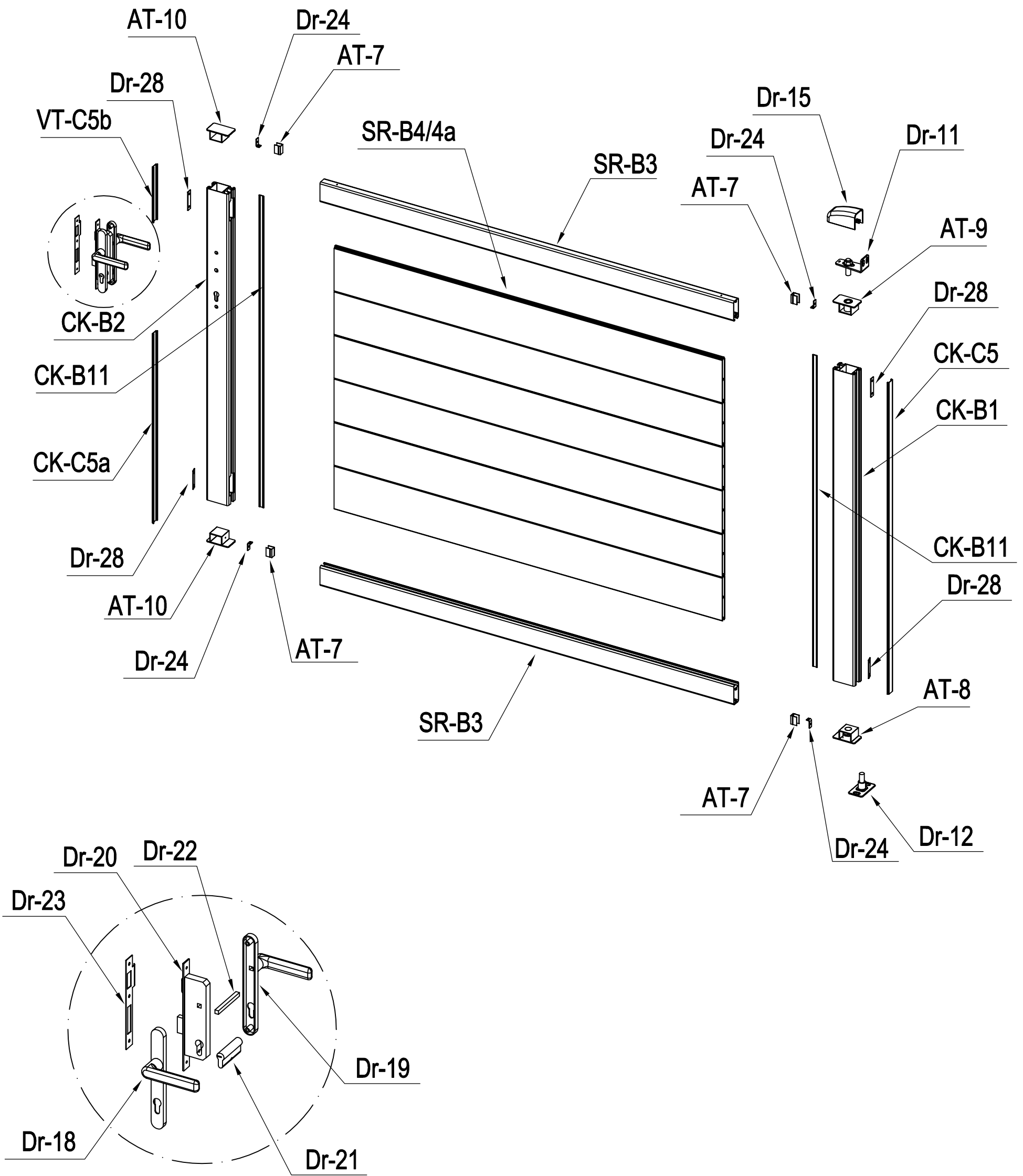

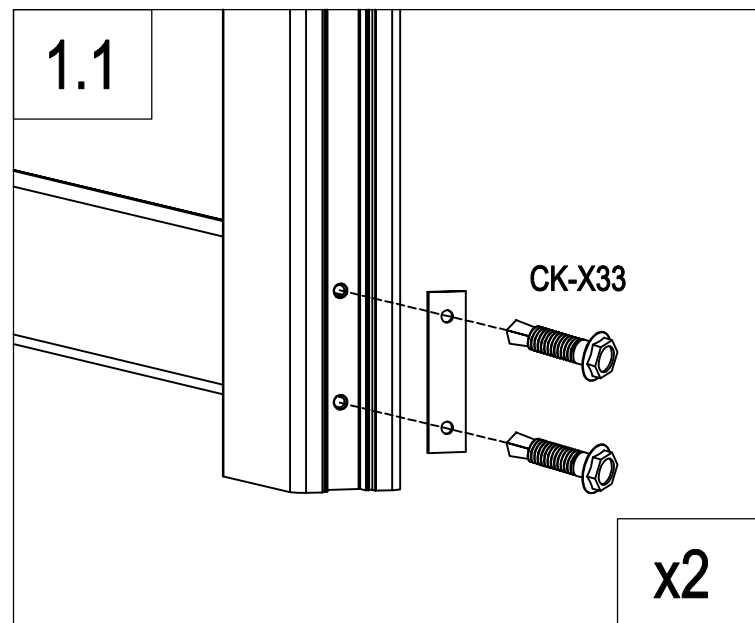
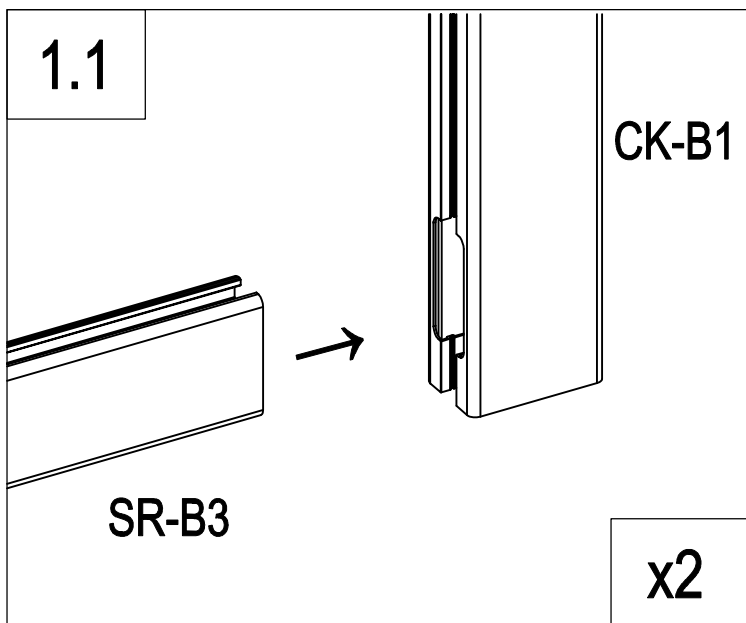
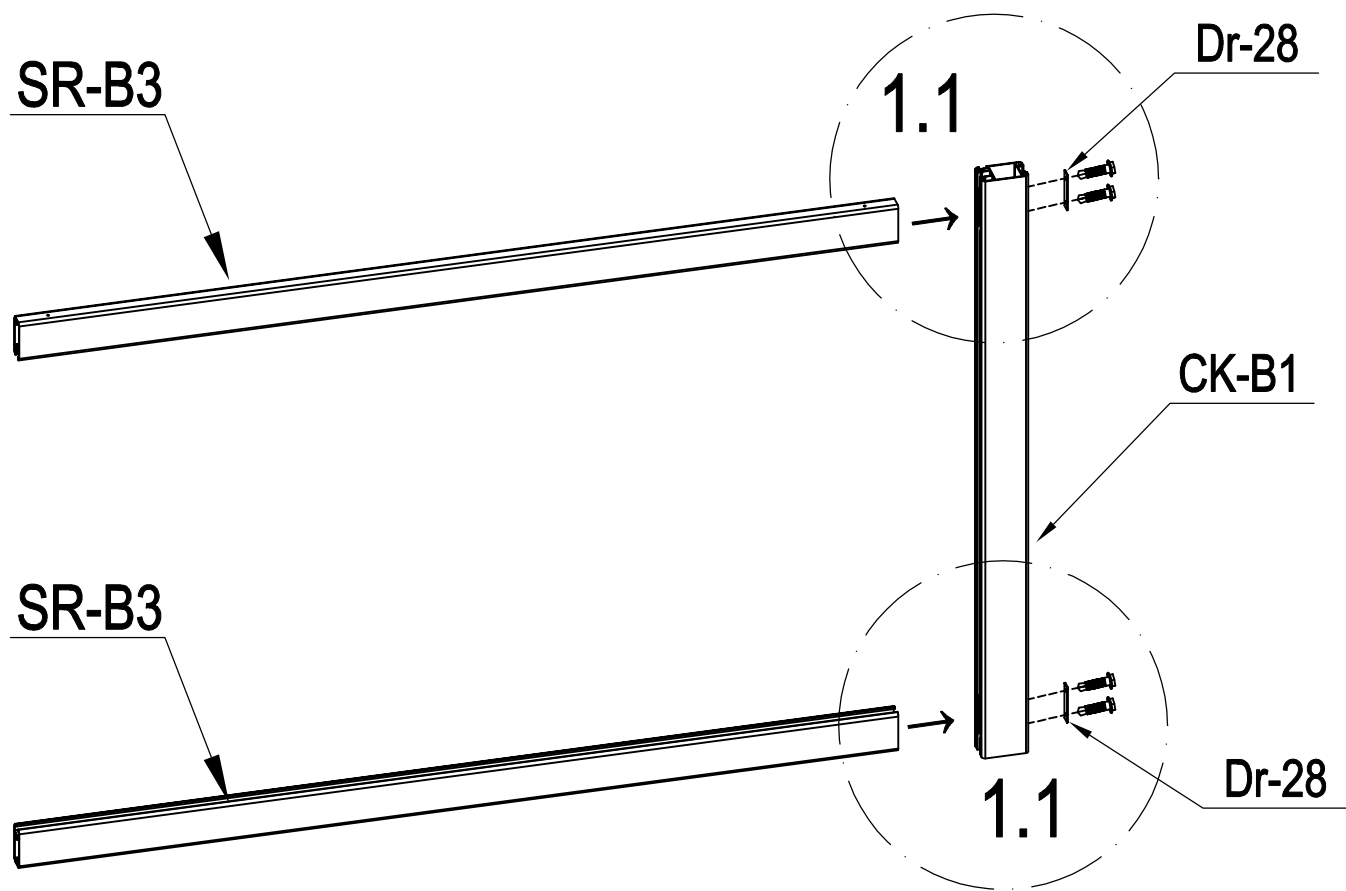

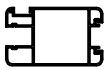
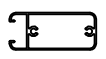

	CK-B1	1
	SR-B3	2
	Dr-28	2
	CK-X33	4

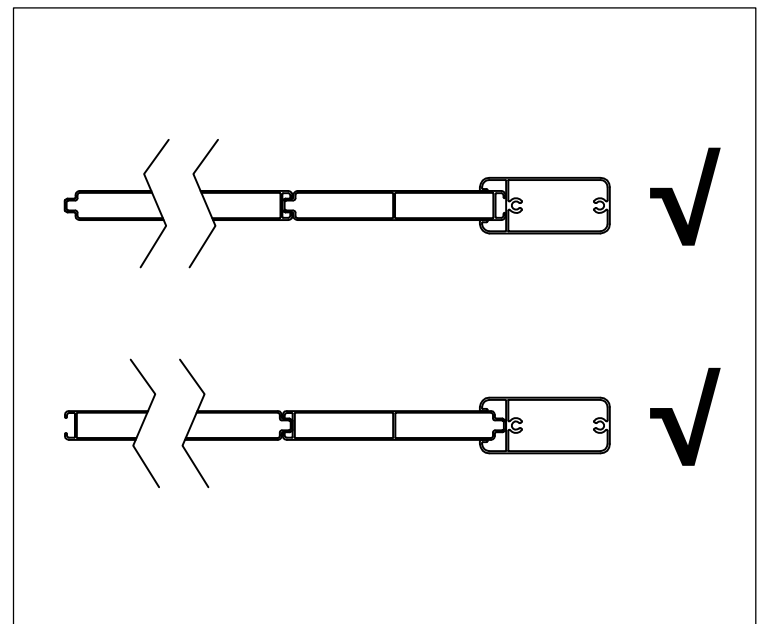
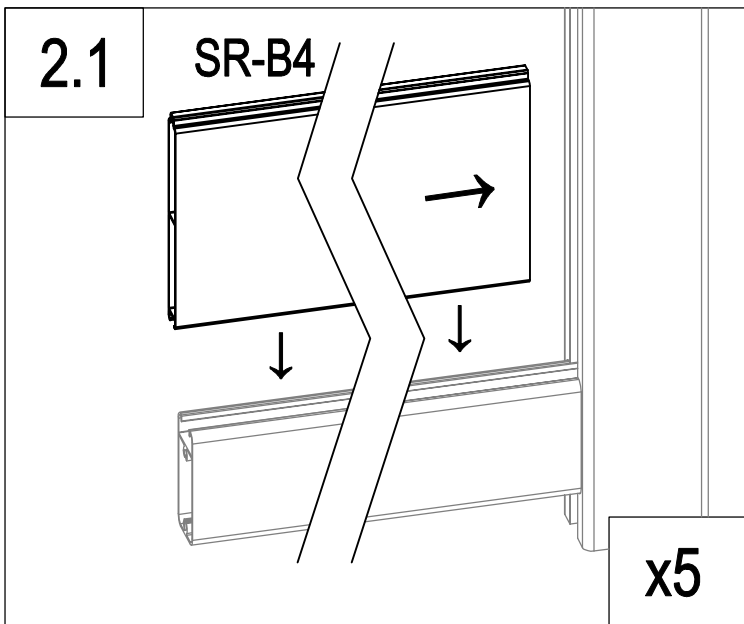
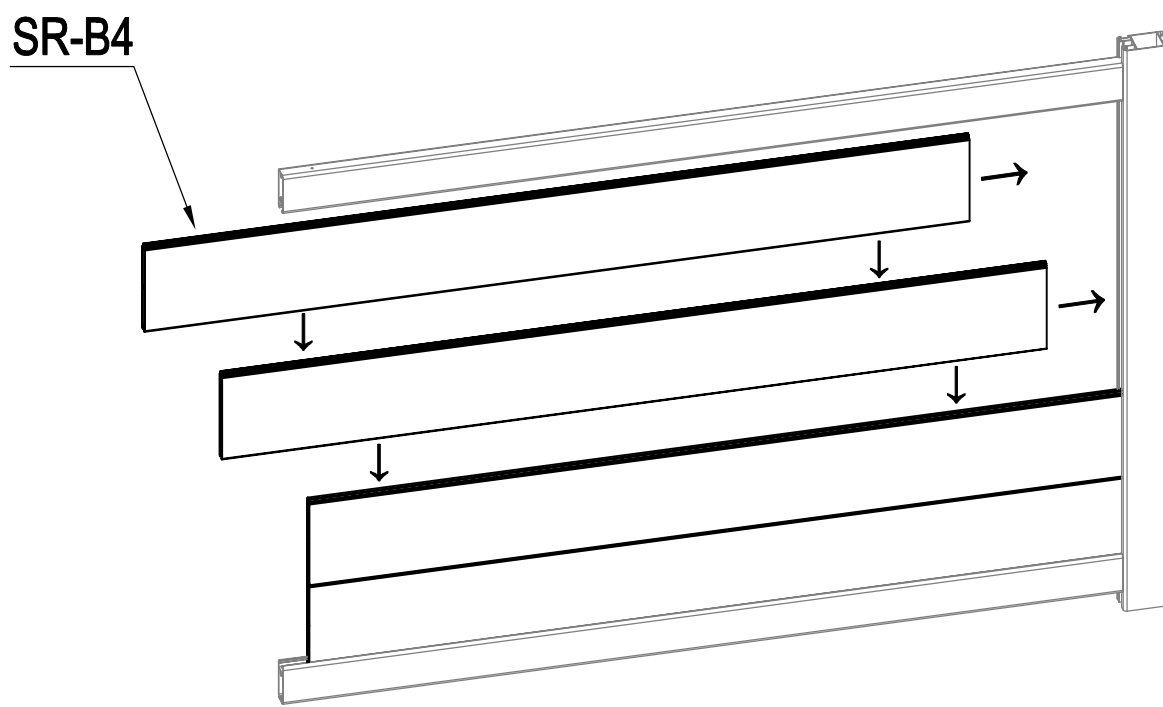

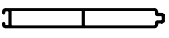
	SR-B4	5
---	-------	---

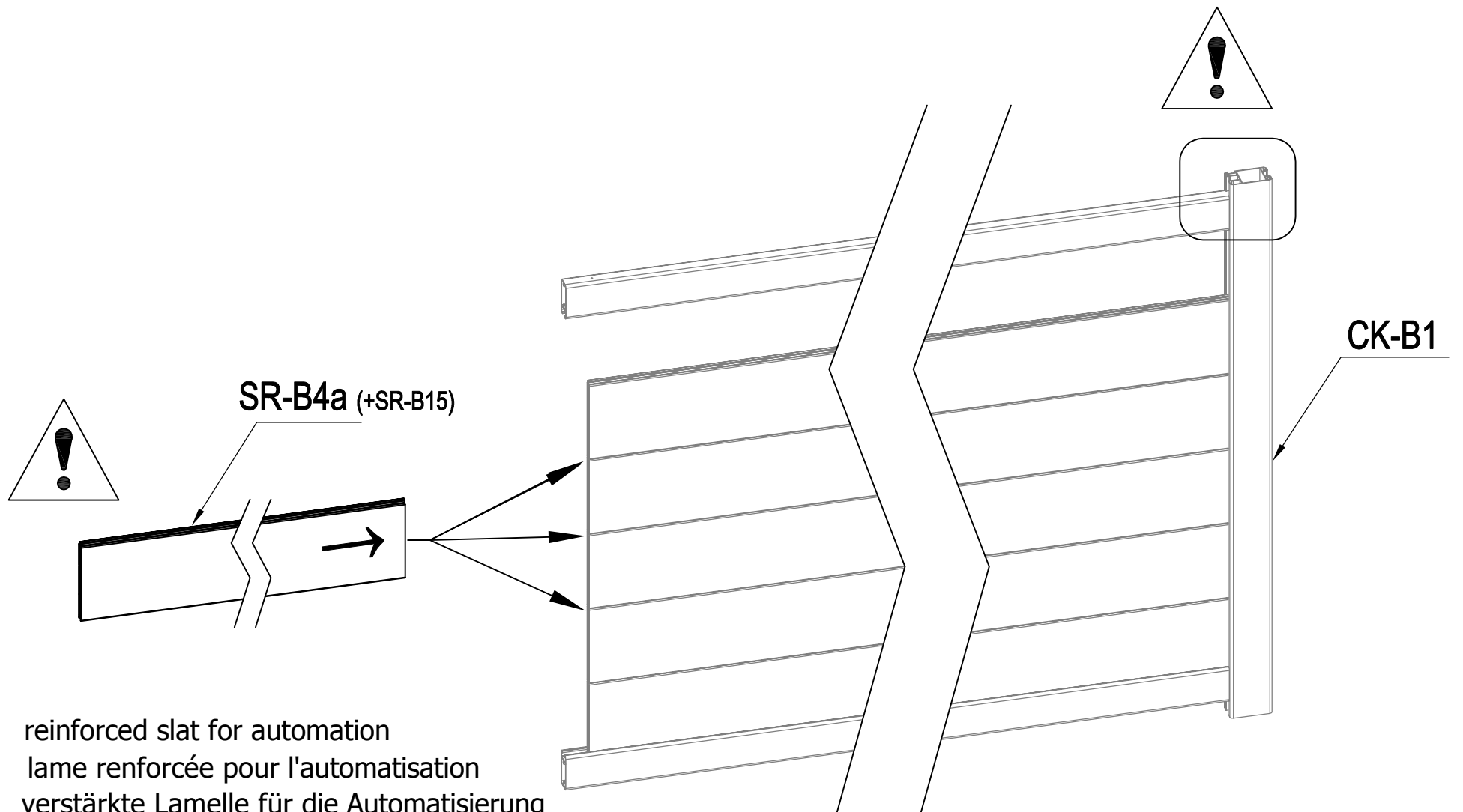

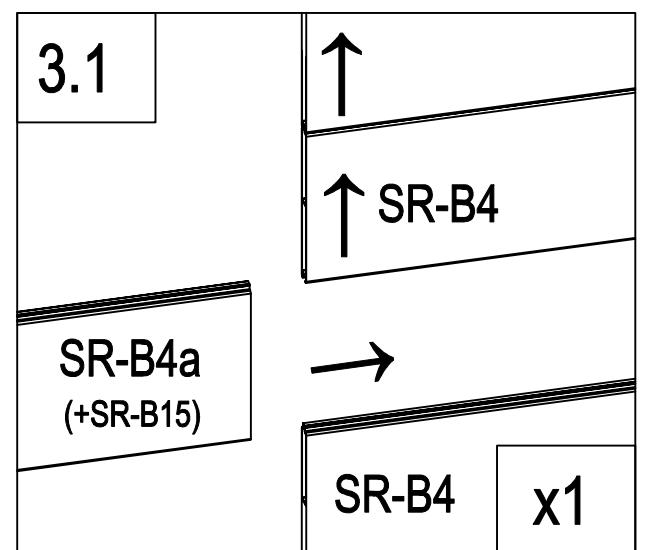
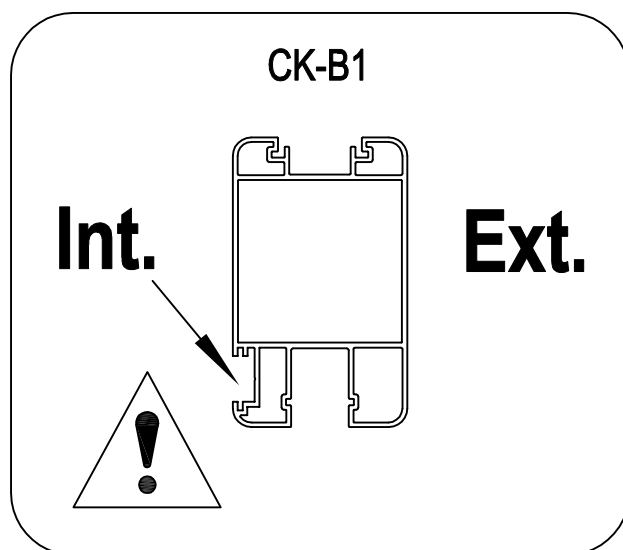
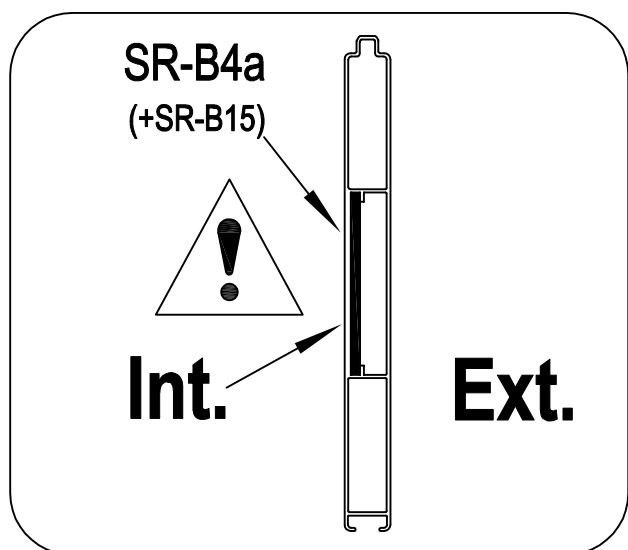

- EN: reinforced slat for automation
- FR: lame renforcée pour l'automatisation
- DE: verstärkte Lamelle für die Automatisierung
- ES: Lámina reforzada para la automatización
- PT: ripa reforçada para automatização
- IT: lamella rinforzata per l'automazione
- NL: versterkte lat voor automatisering
- PL: wzmocniona listwa do automatyzacji

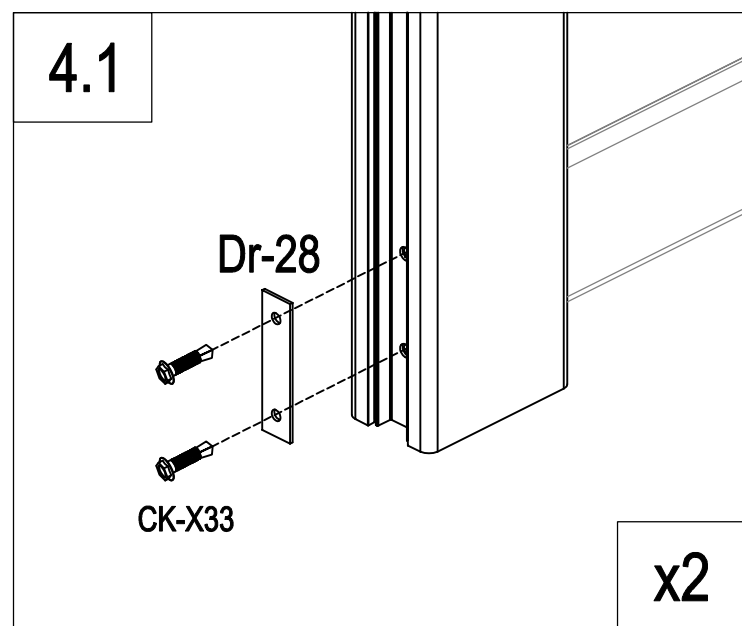
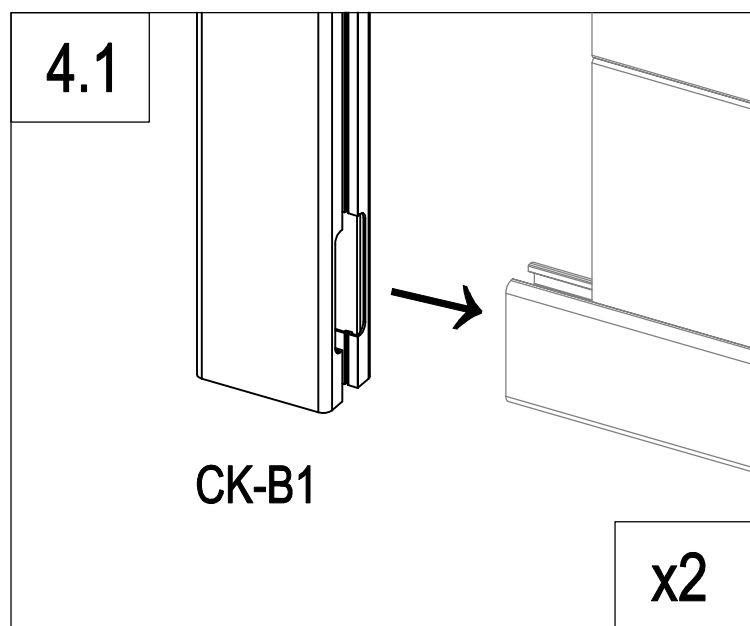
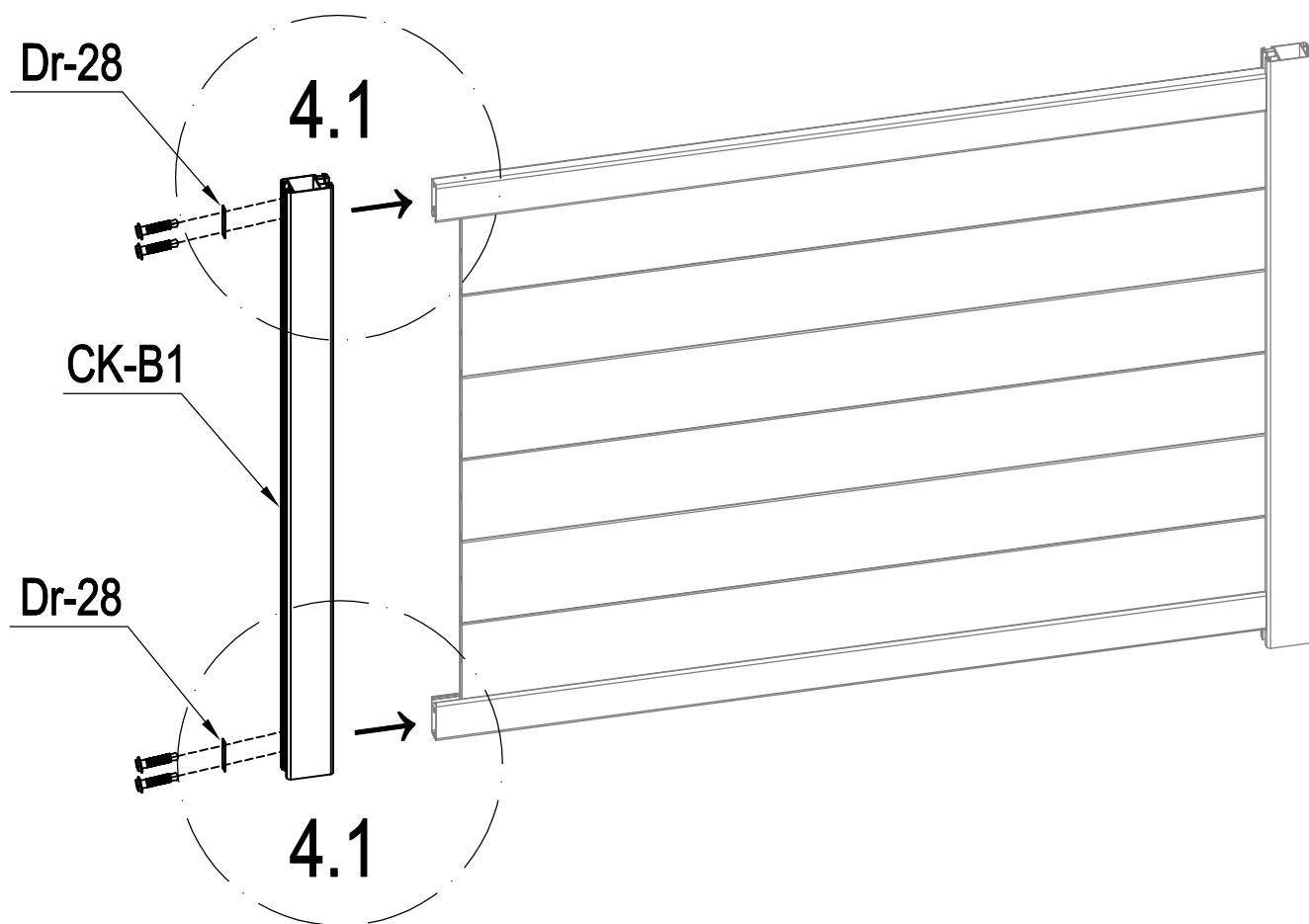

	SR-B4a (+SR-B15)	1
---	------------------	---

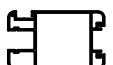

	CK-B1	1
	Dr-28	2
	CK-X33	4

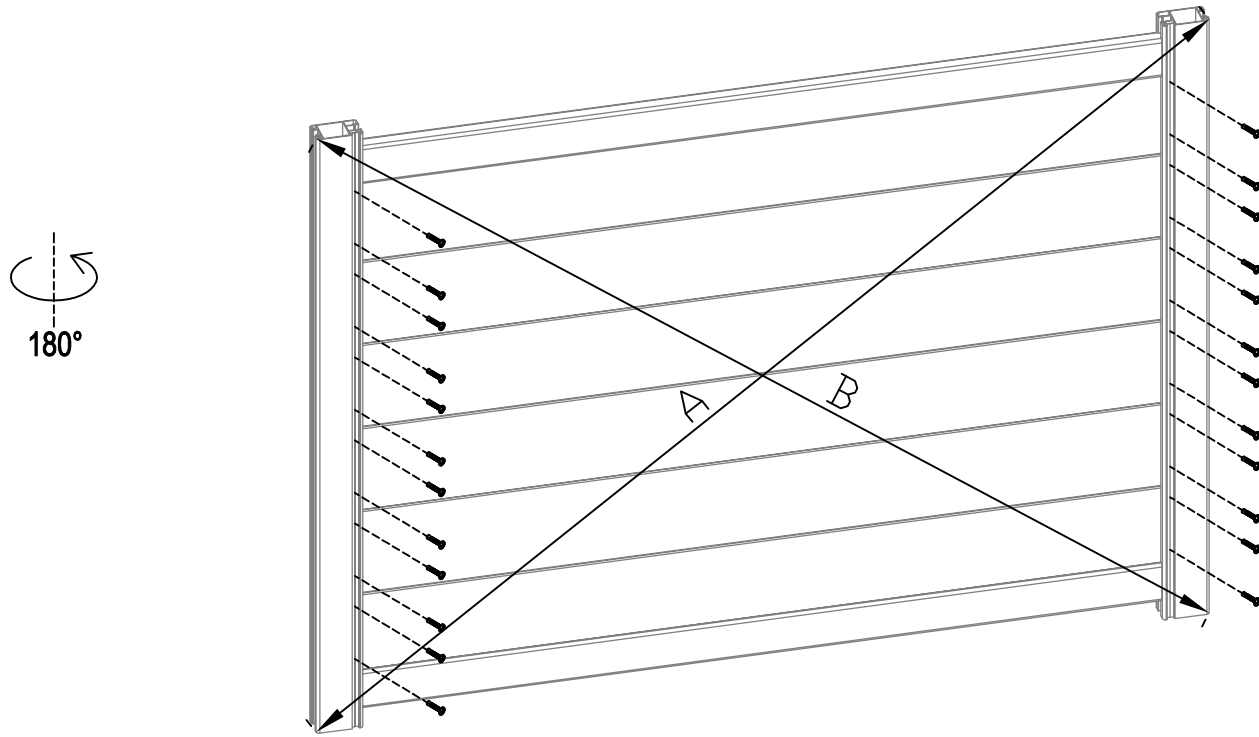

A=B

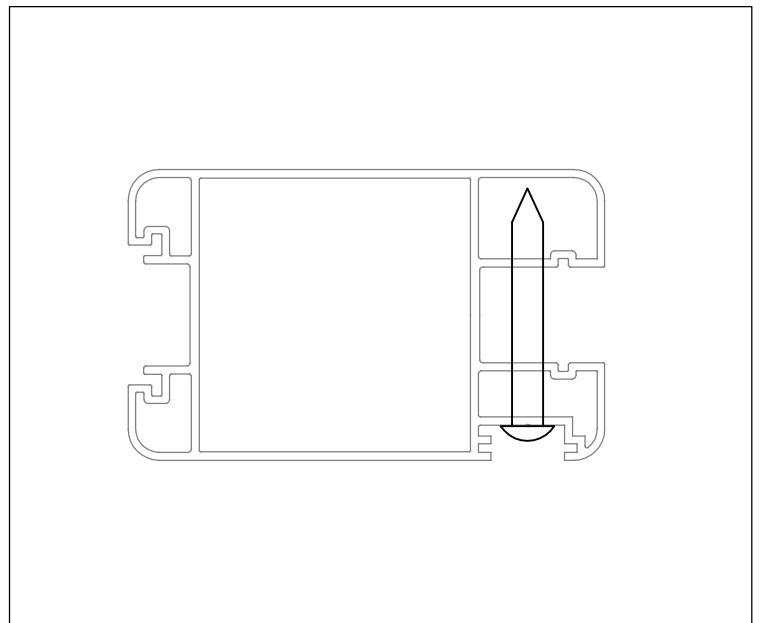
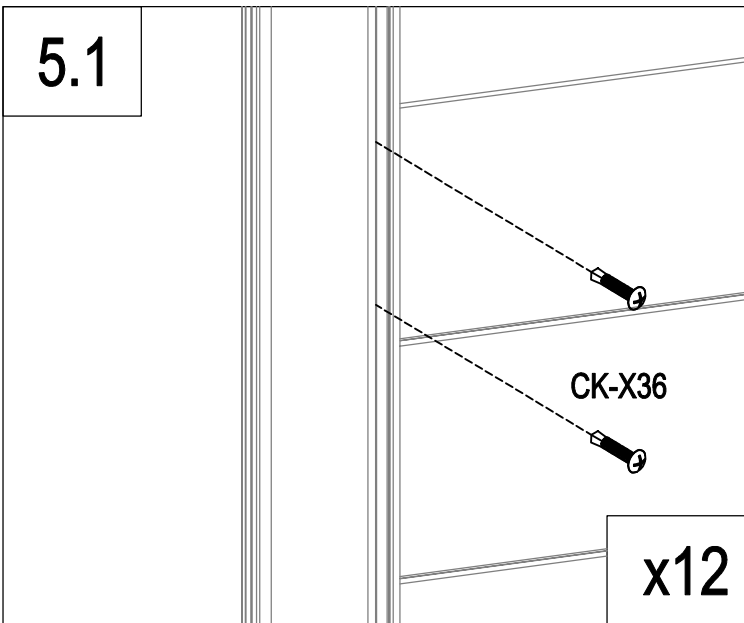

	<p>CK-X36</p>	<p>24</p>
---	---------------	-----------

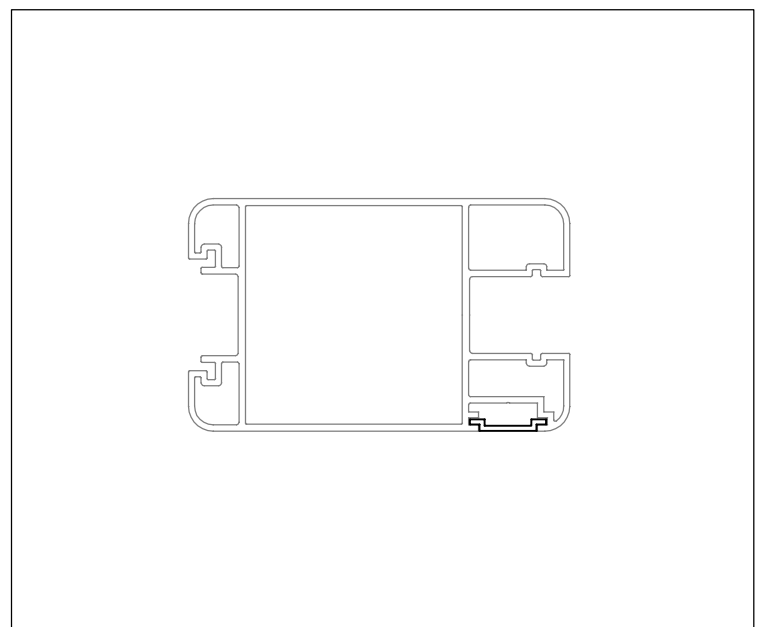
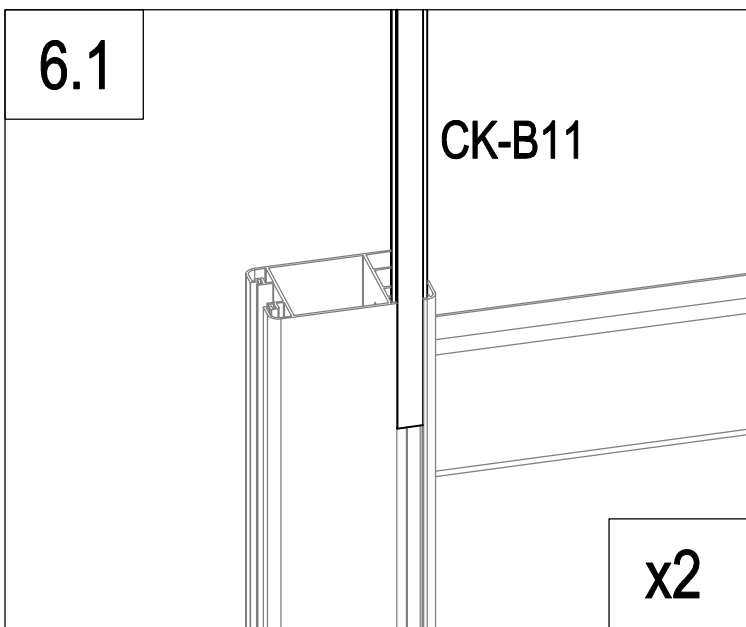
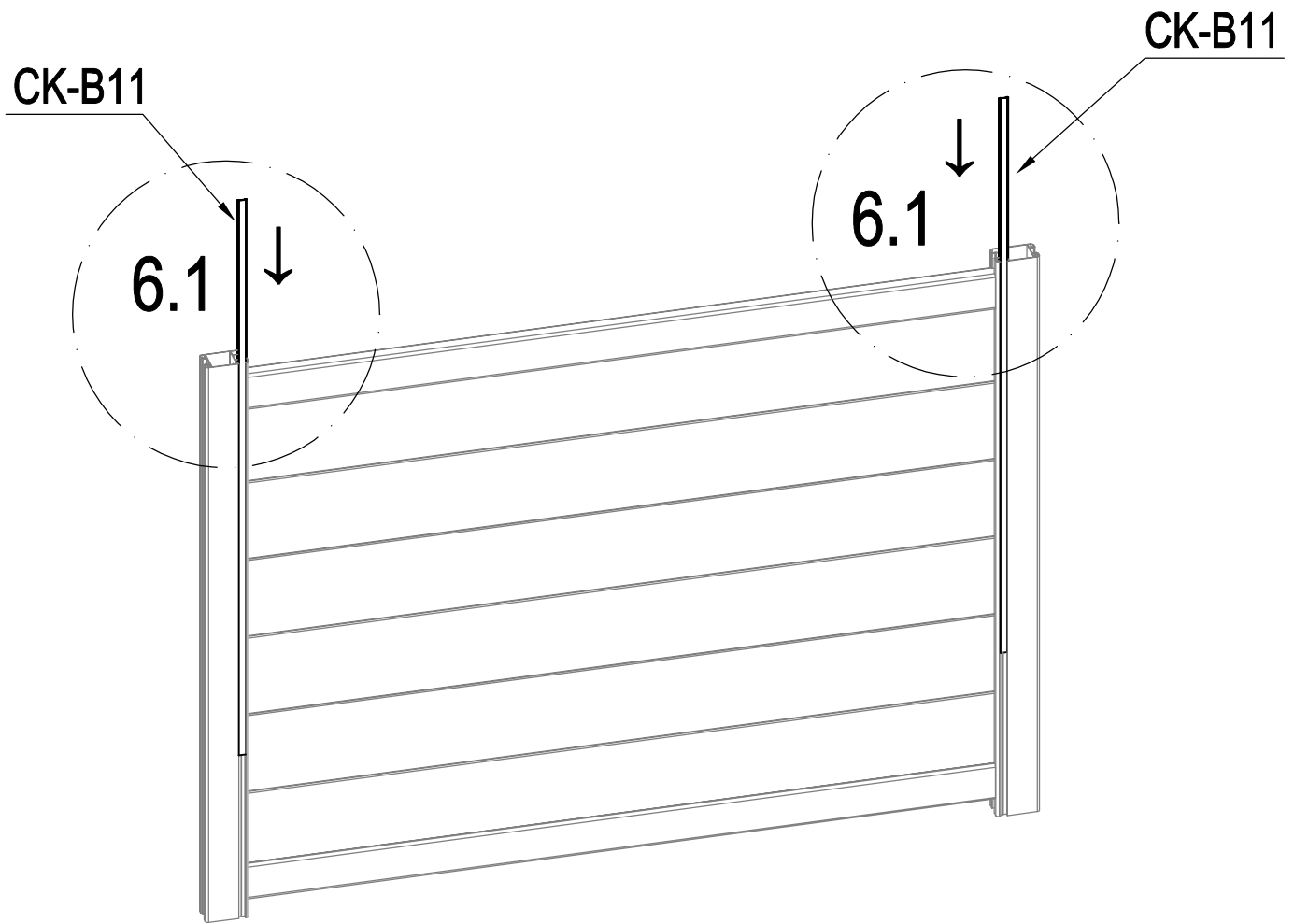



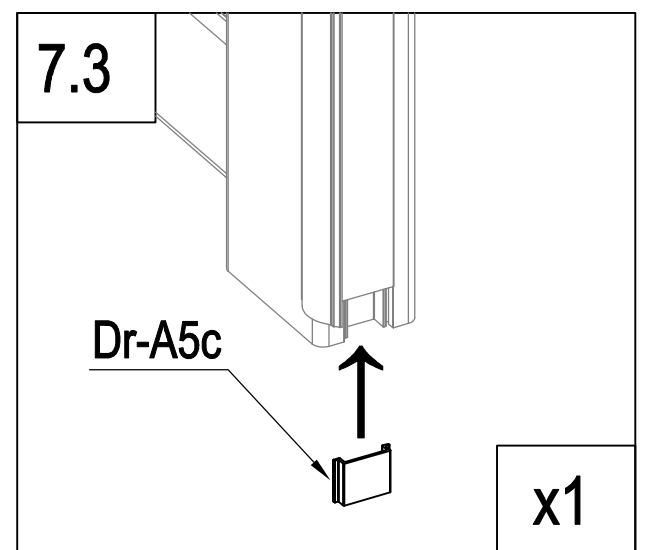
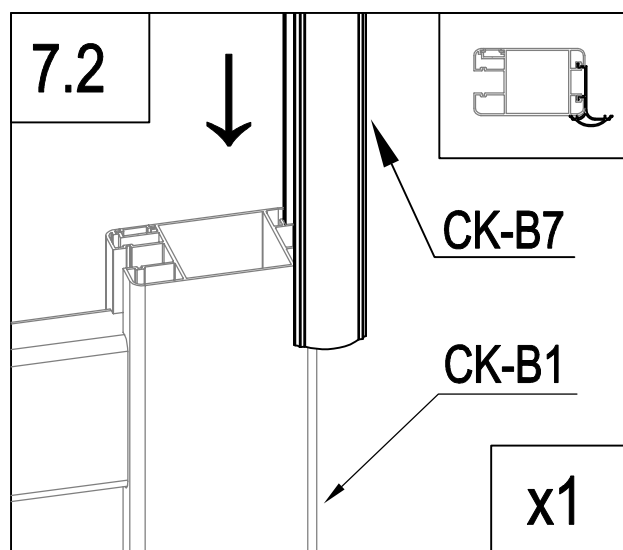
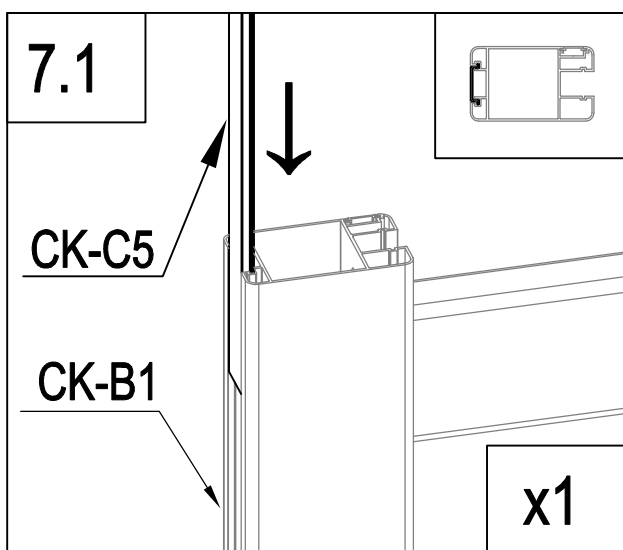
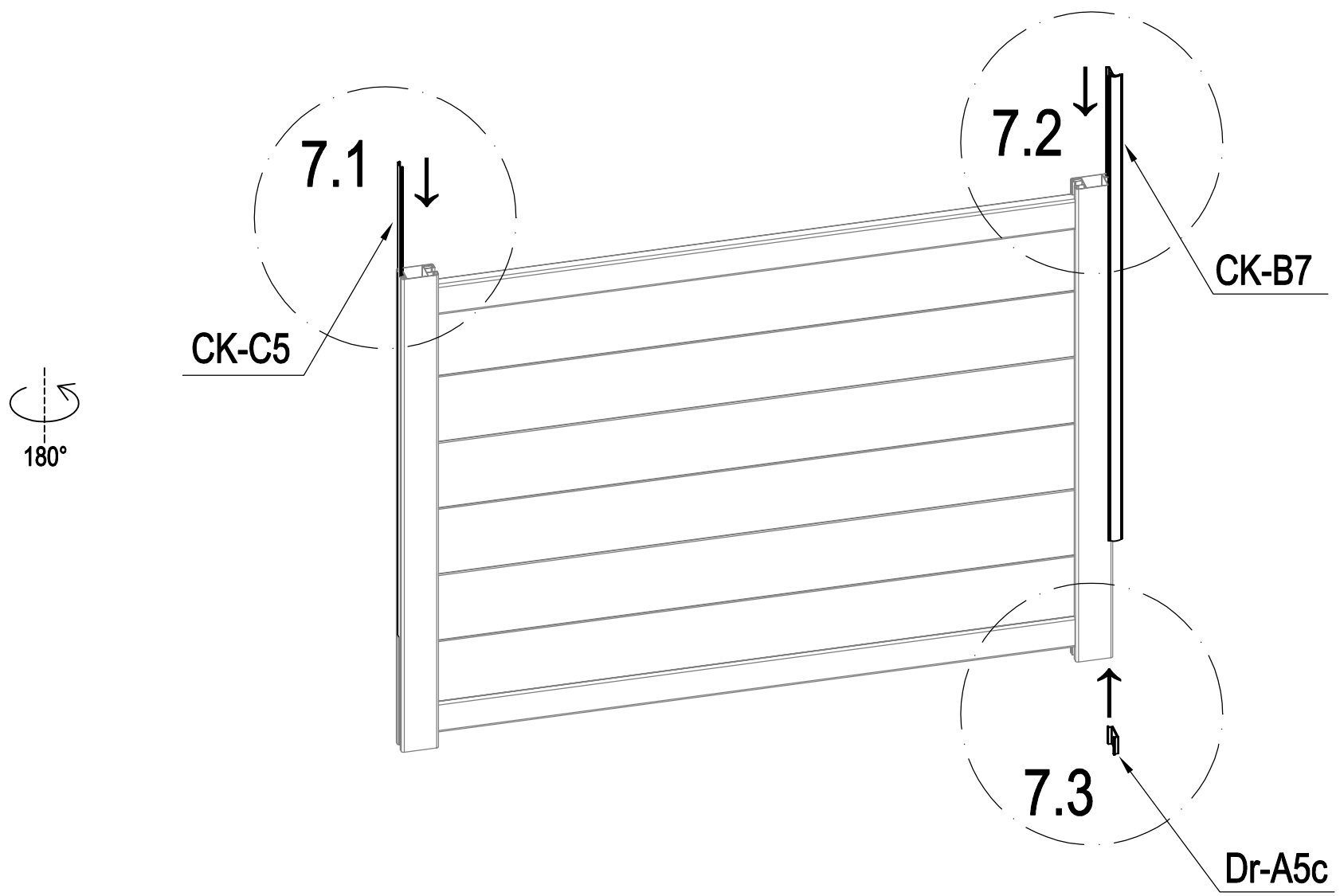

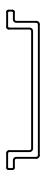
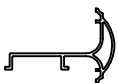

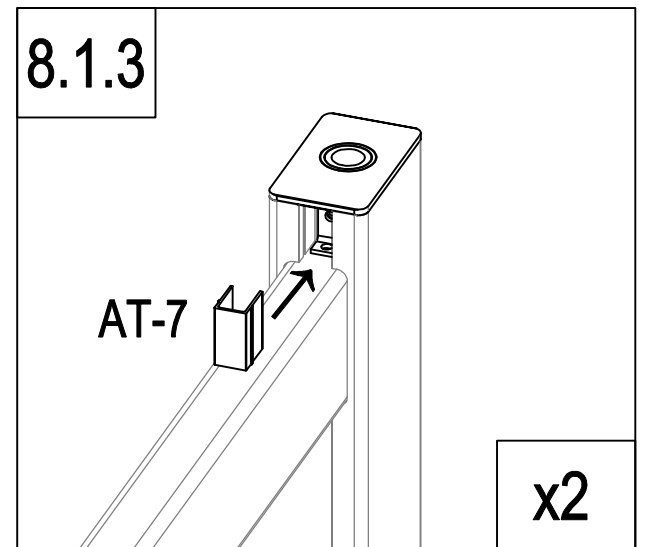
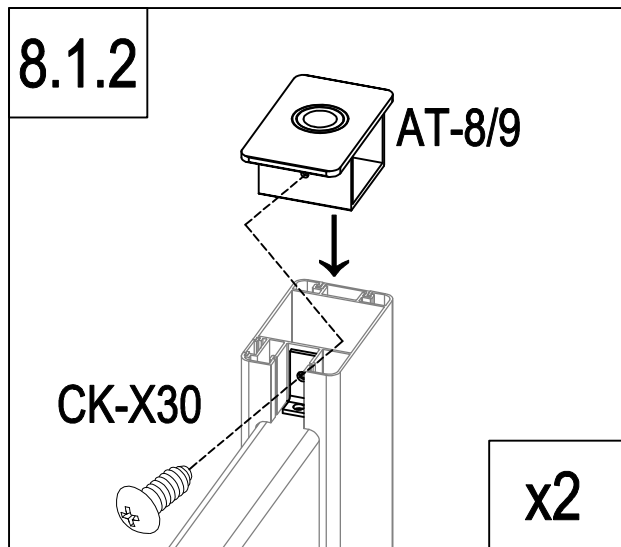
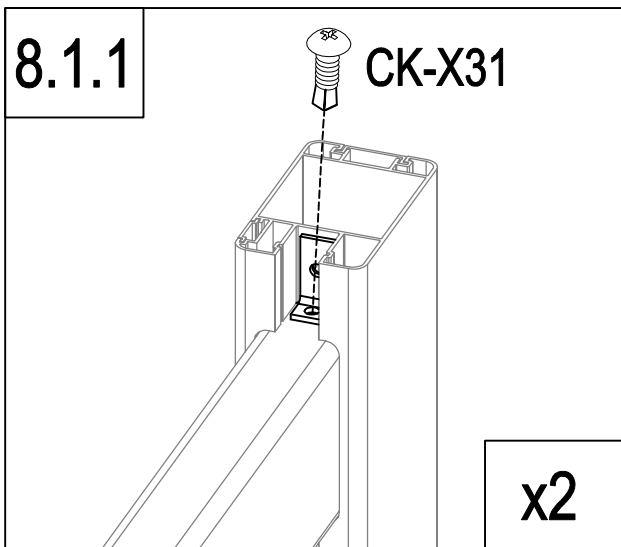
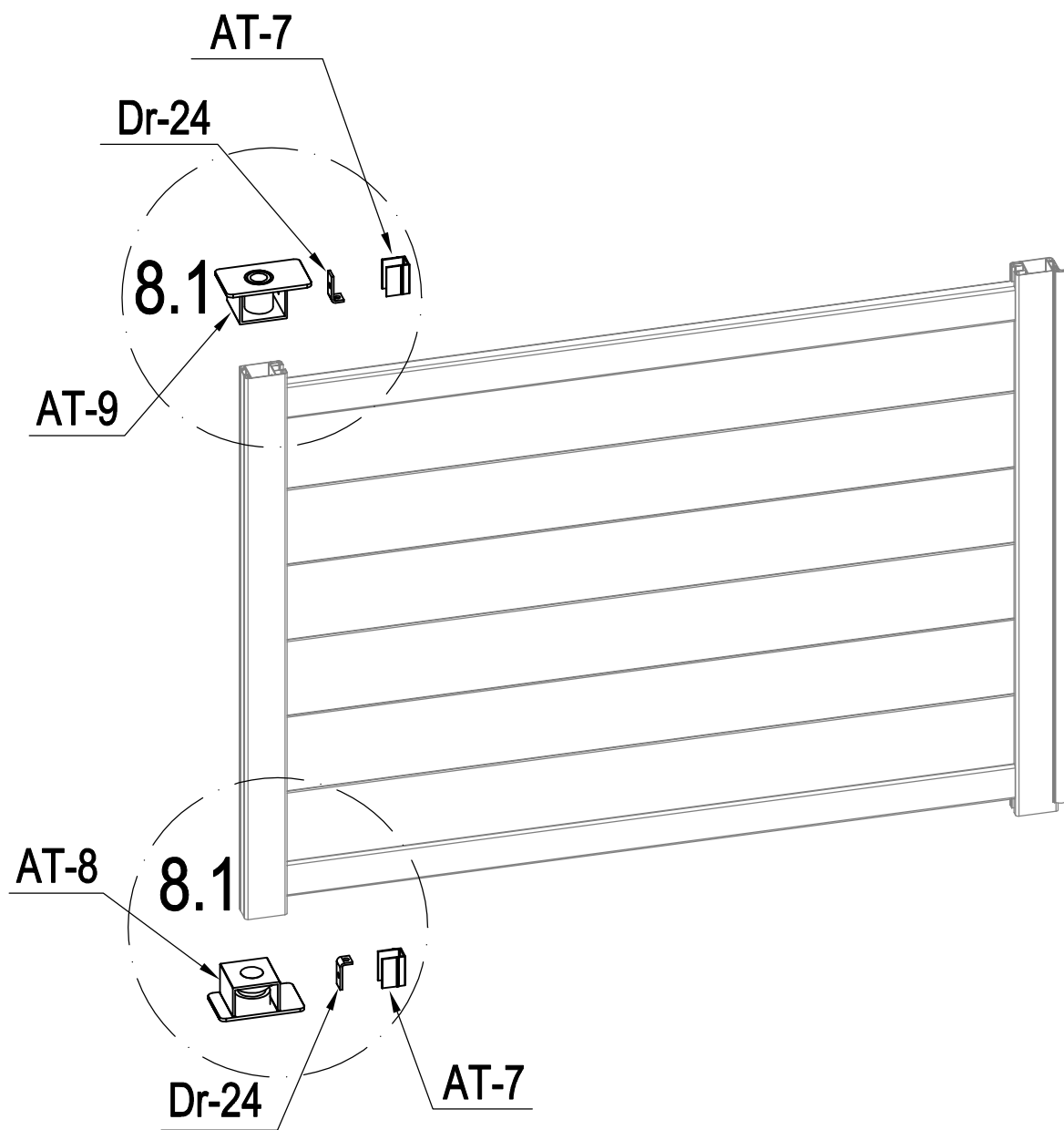
	CK-B11	2
---	--------	---

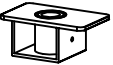

	CK-C5	1
	Dr-A5c	1
	CK-B7	1



	AT-8	1
	AT-9	1
	Dr-24	2

	AT-7	2
	CK-X30	2
	CK-X31	2

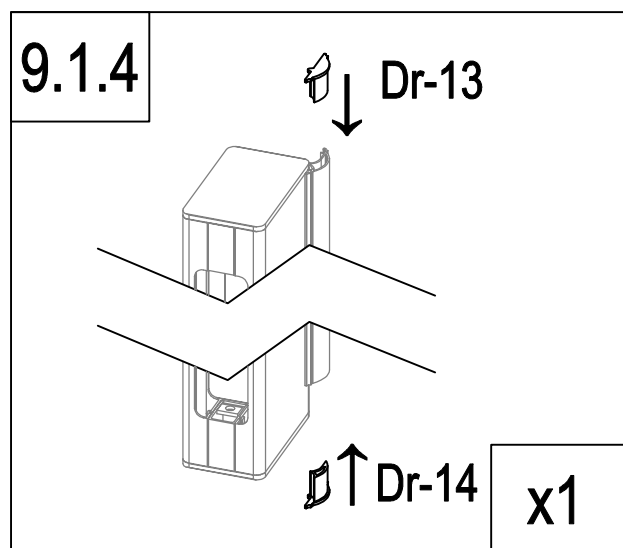
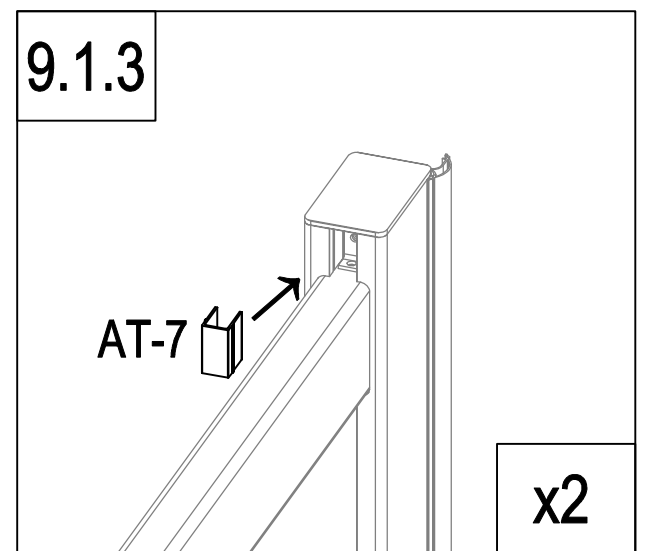
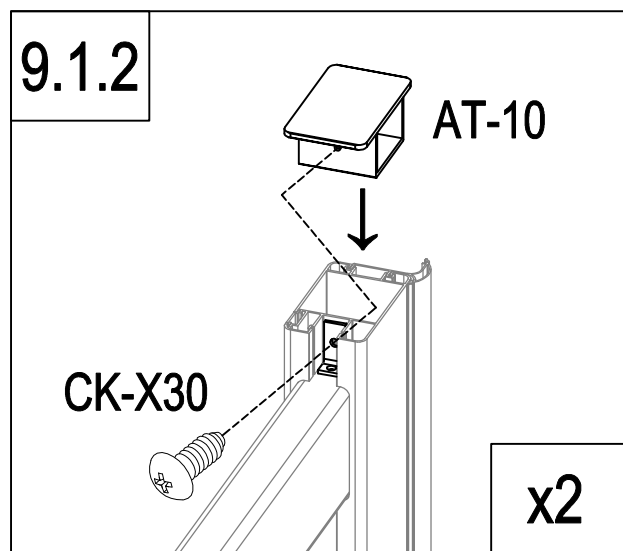
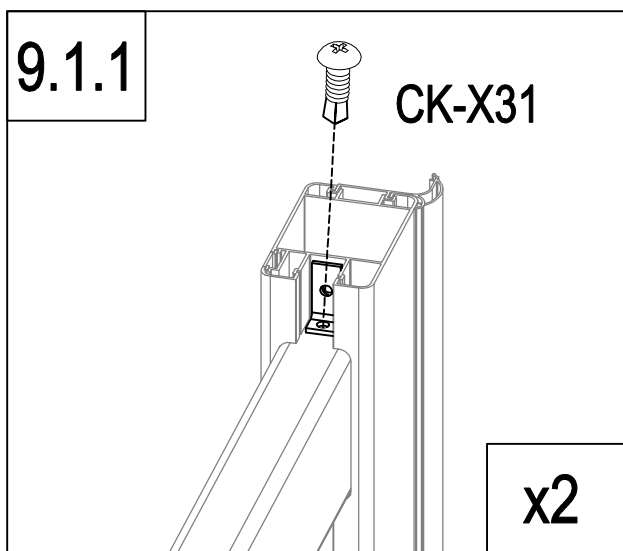
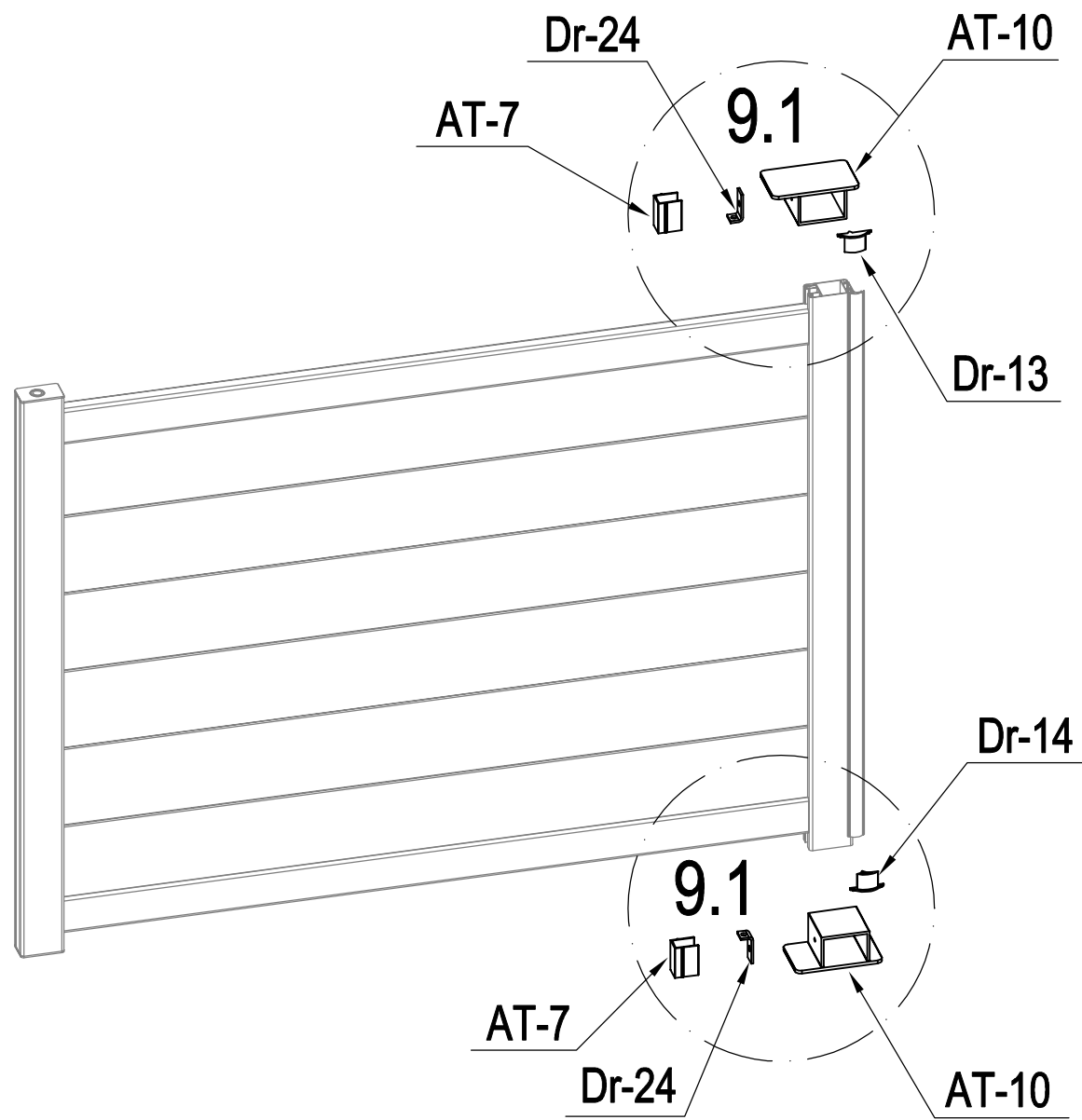

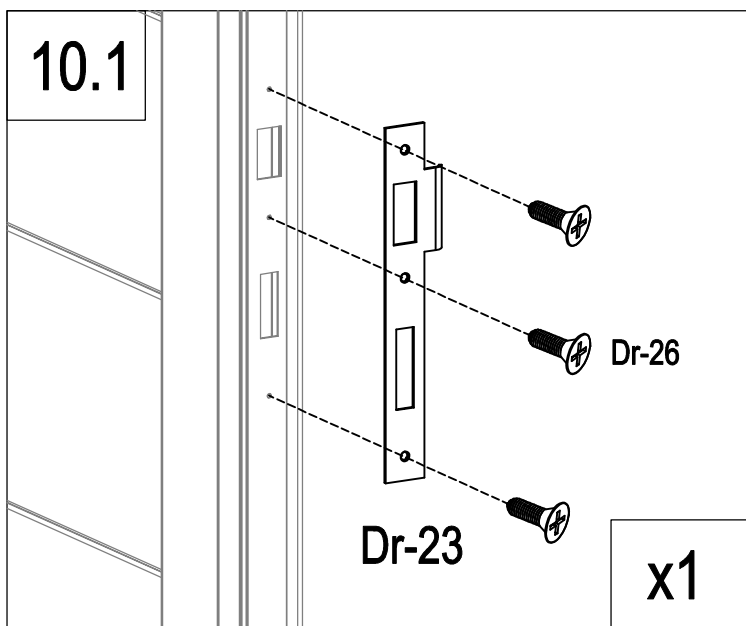
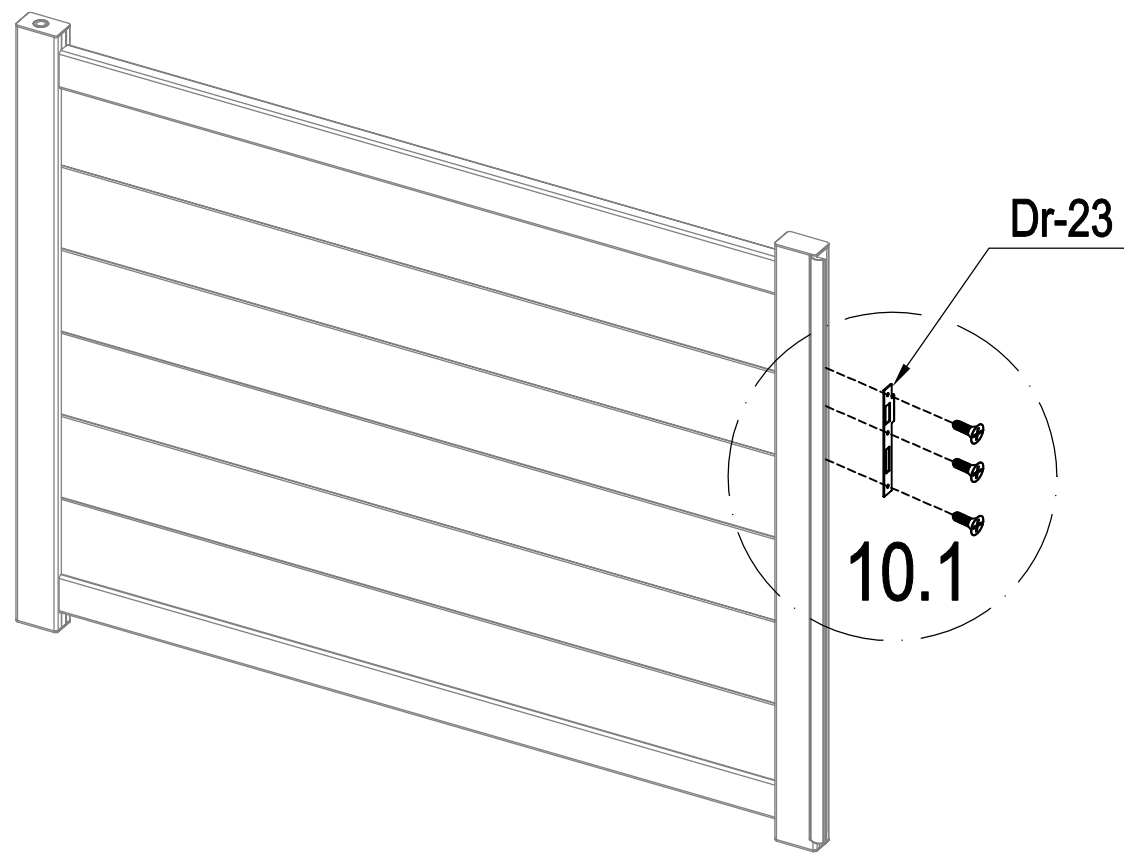

	AT-10	2
	Dr-24	2
	AT-7	2
	Dr-13	1

	Dr-14	1
	CK-X30	2
	CK-X31	2

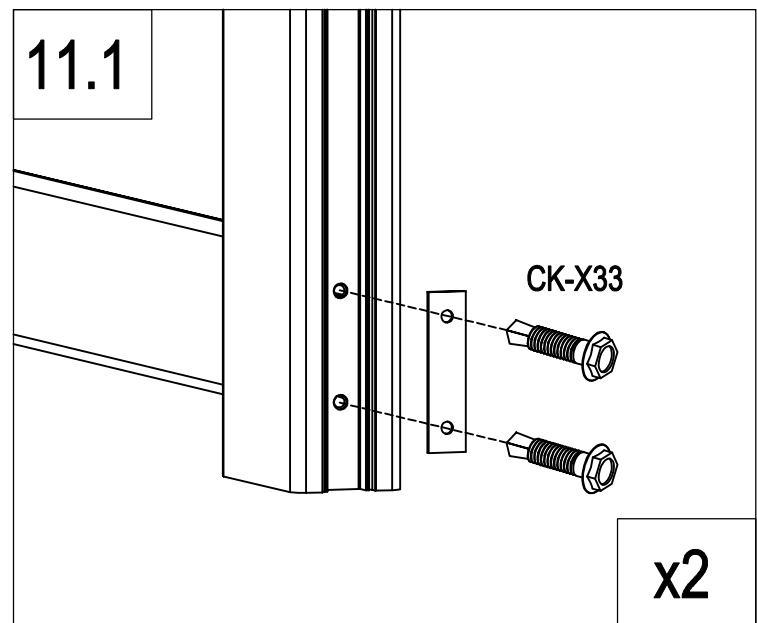
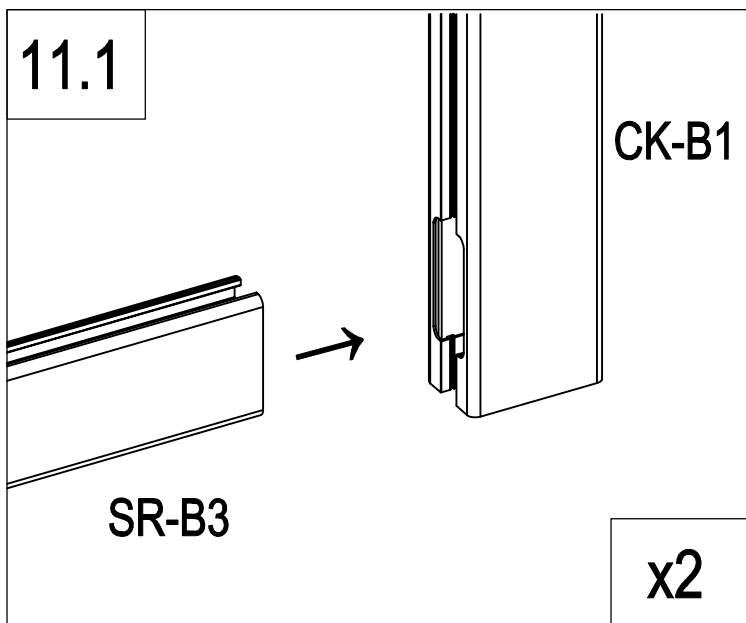
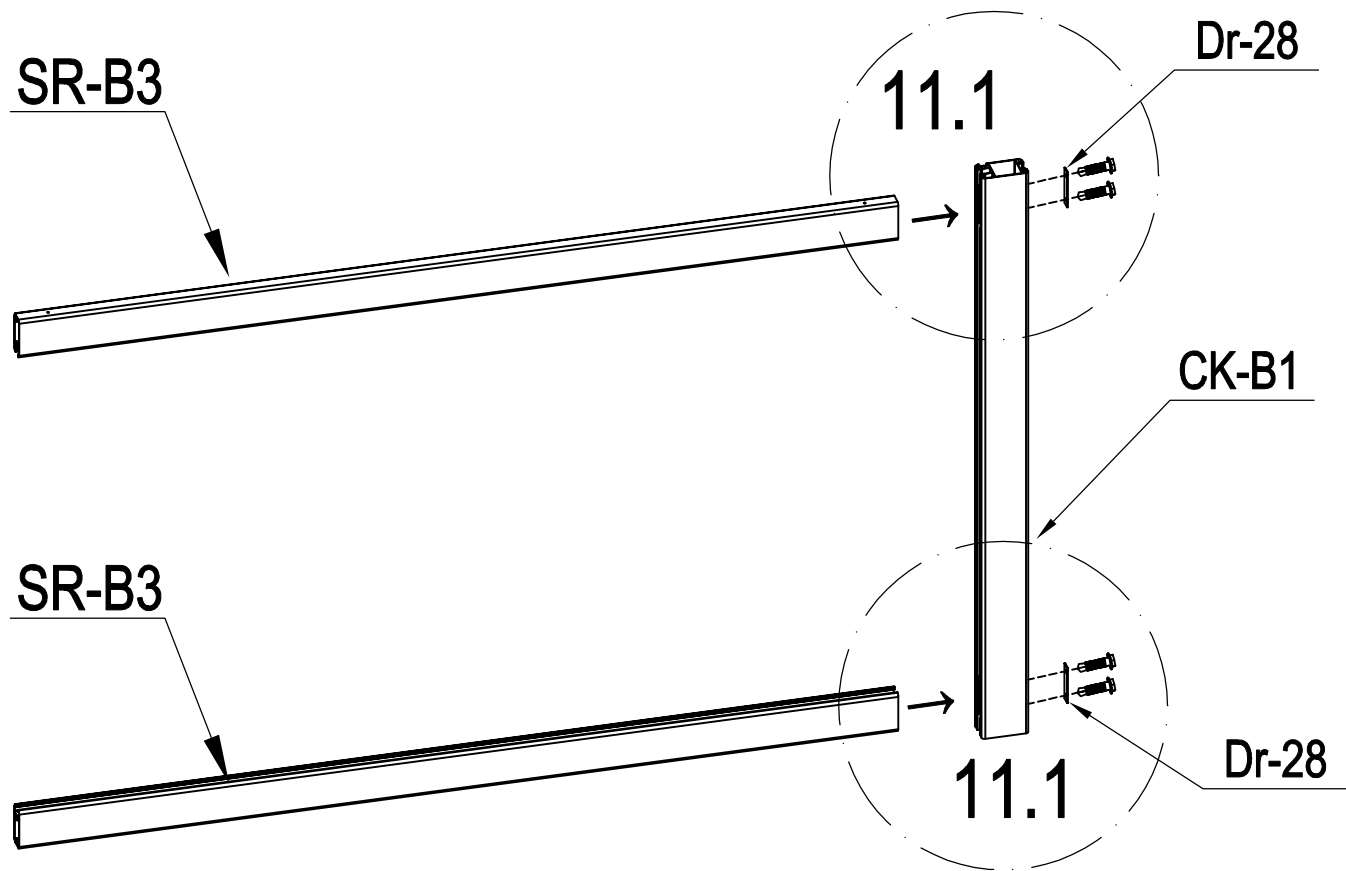

	Dr-23	1
	Dr-26	3

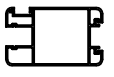
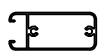

	CK-B1	1
	SR-B3	2
	Dr-28	2
	CK-X33	4

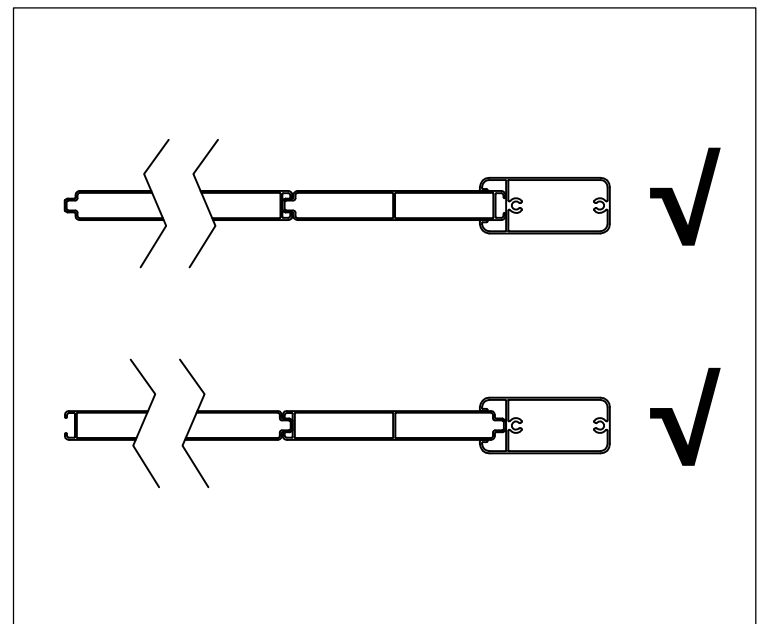
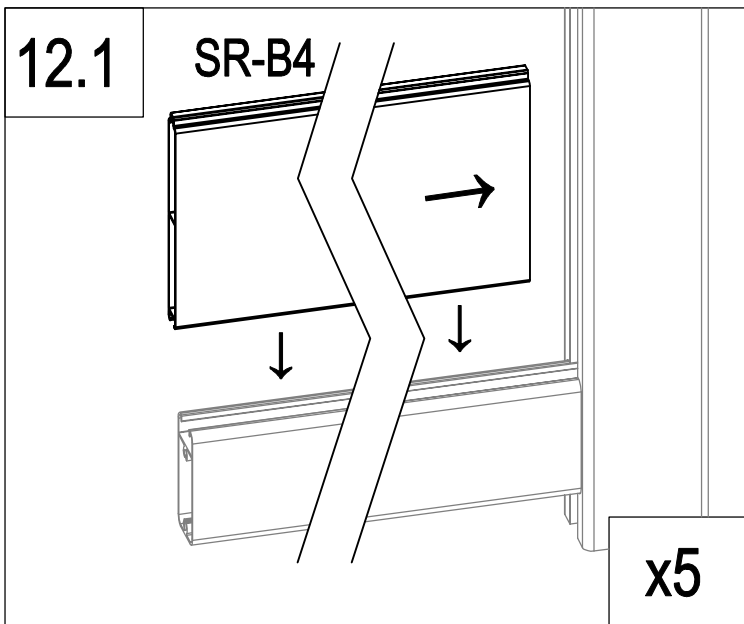
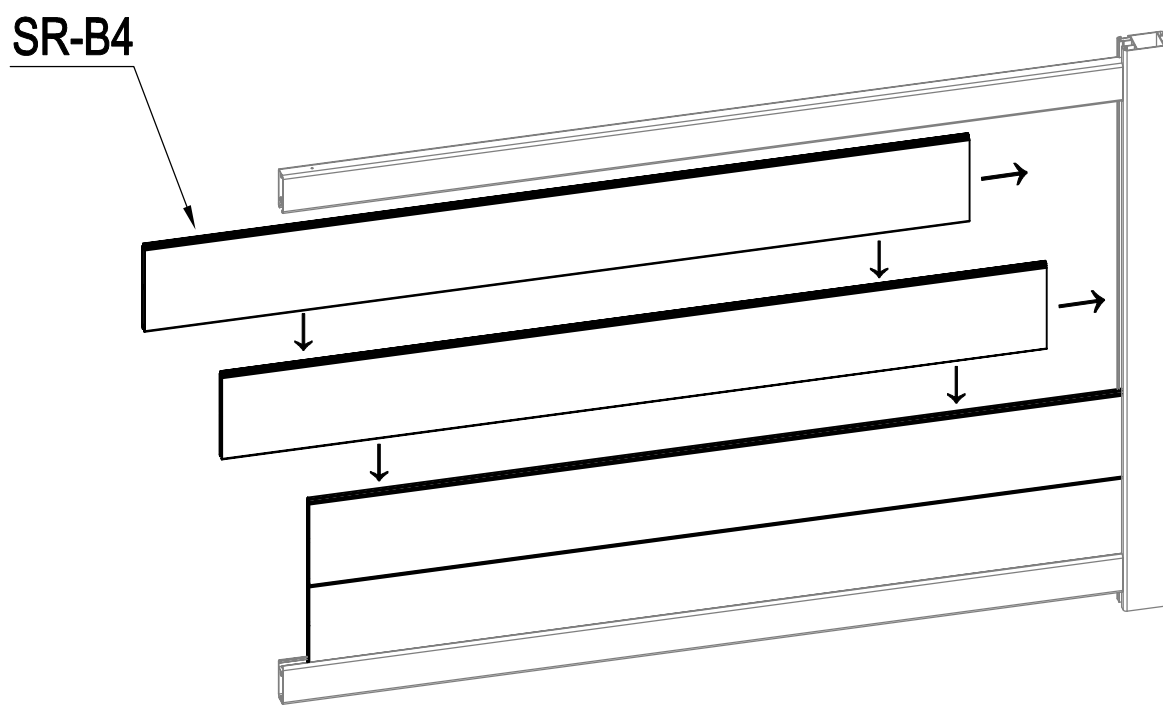

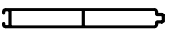
	SR-B4	5
---	-------	---

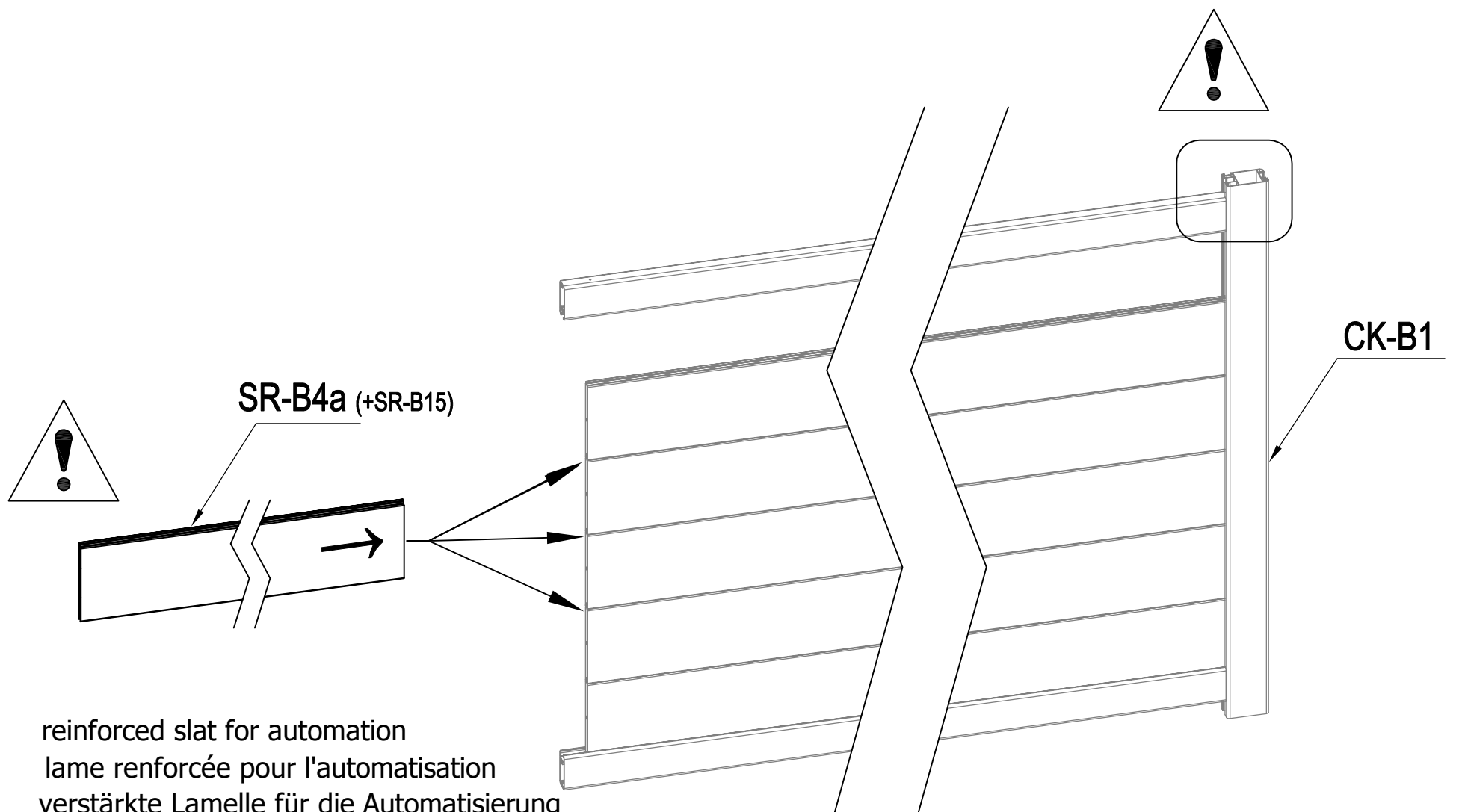

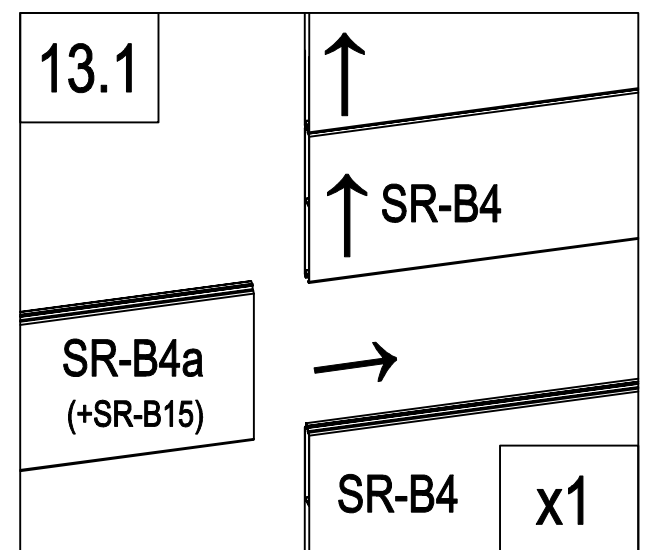
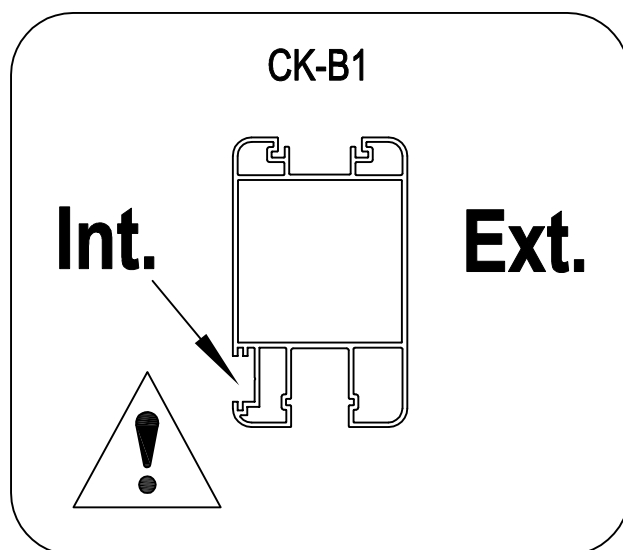
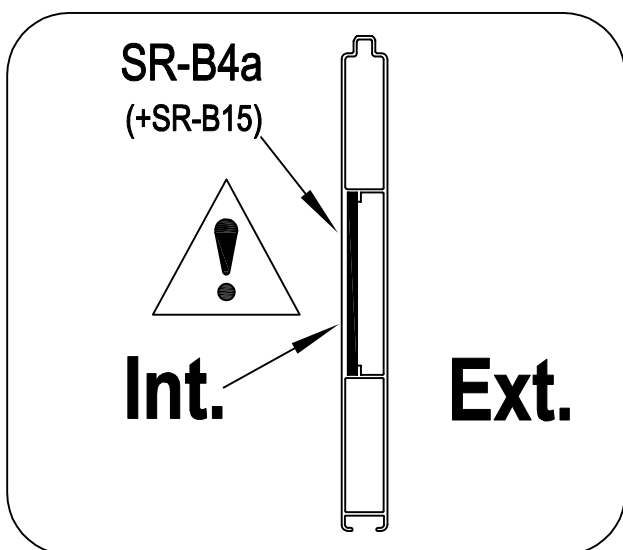

- EN: reinforced slat for automation
- FR: lame renforcée pour l'automatisation
- DE: verstärkte Lamelle für die Automatisierung
- ES: Lámina reforzada para la automatización
- PT: ripa reforçada para automatização
- IT: lamella rinforzata per l'automazione
- NL: versterkte lat voor automatisering
- PL: wzmocniona listwa do automatyzacji

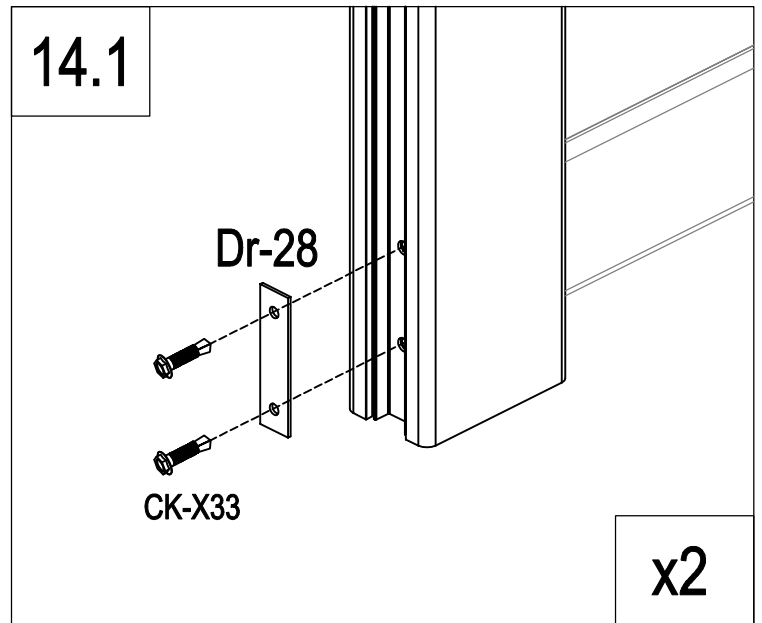
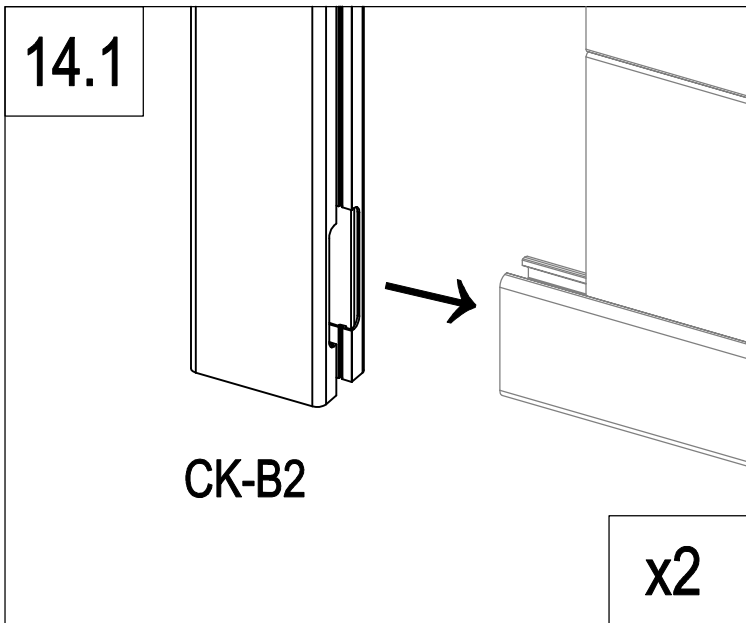
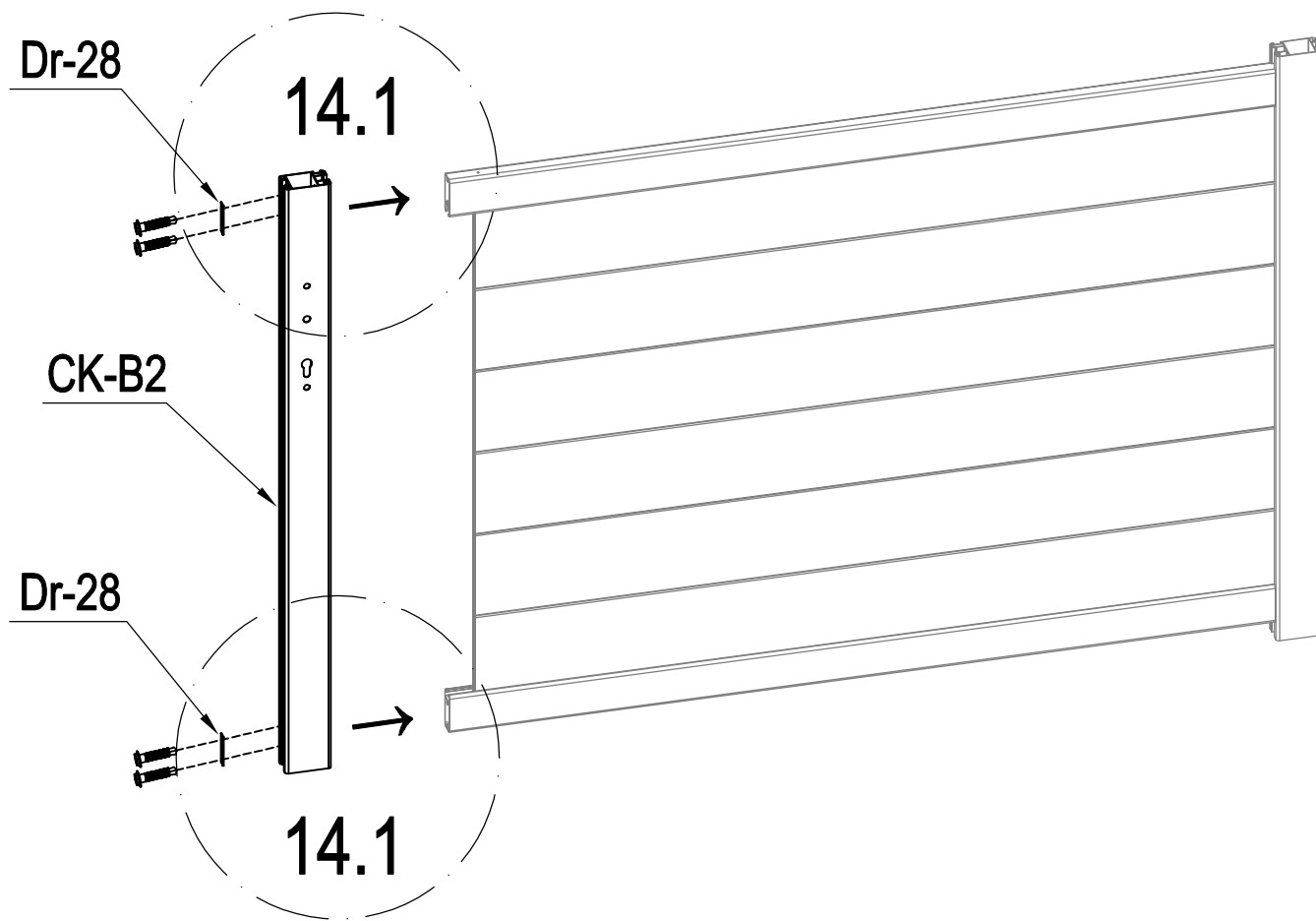

	SR-B4a (+SR-B15)	1
---	------------------	---

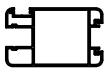

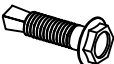
	CK-B2	1
	Dr-28	2
	CK-X33	4

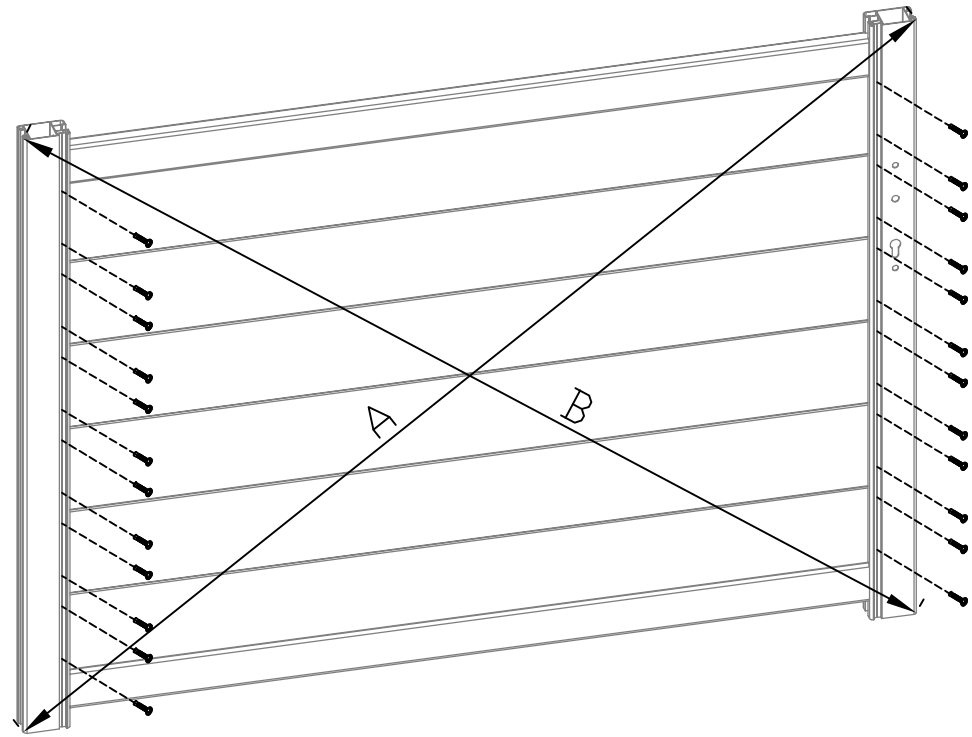
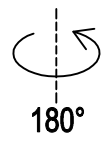

A=B

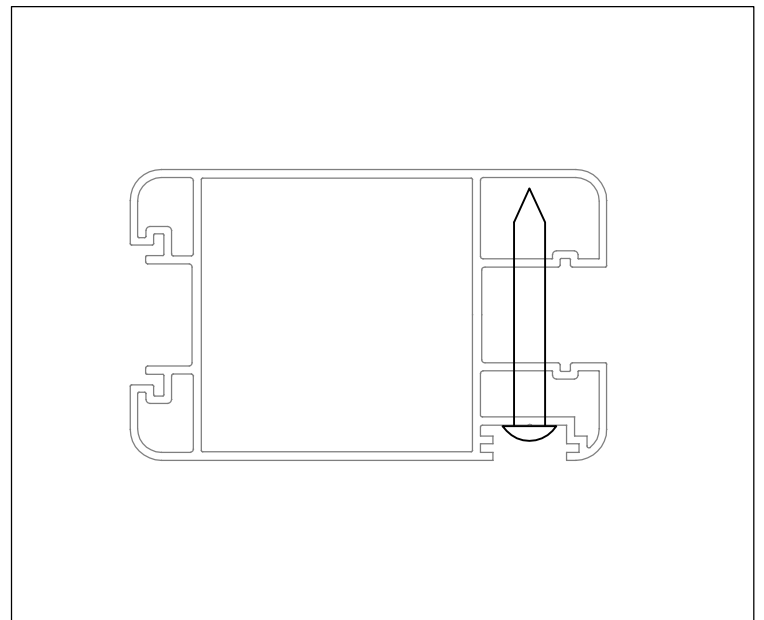
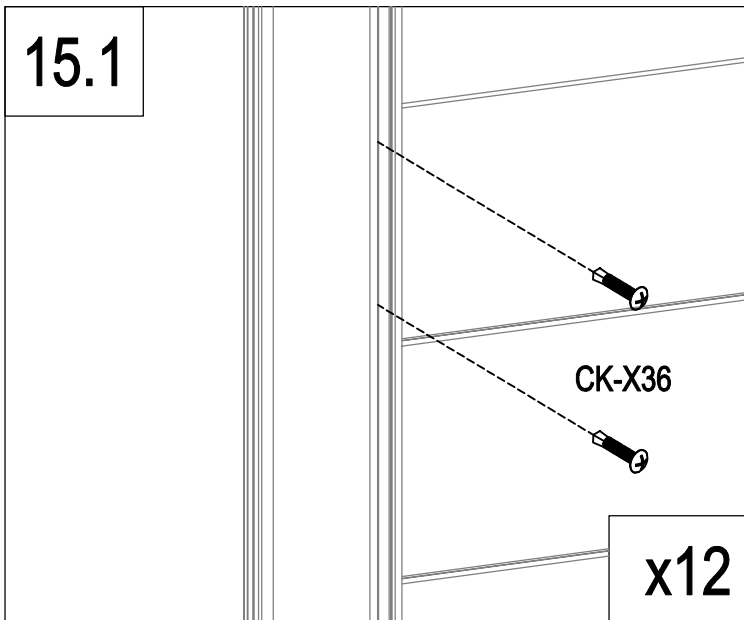

	CK-X36	24
---	--------	----

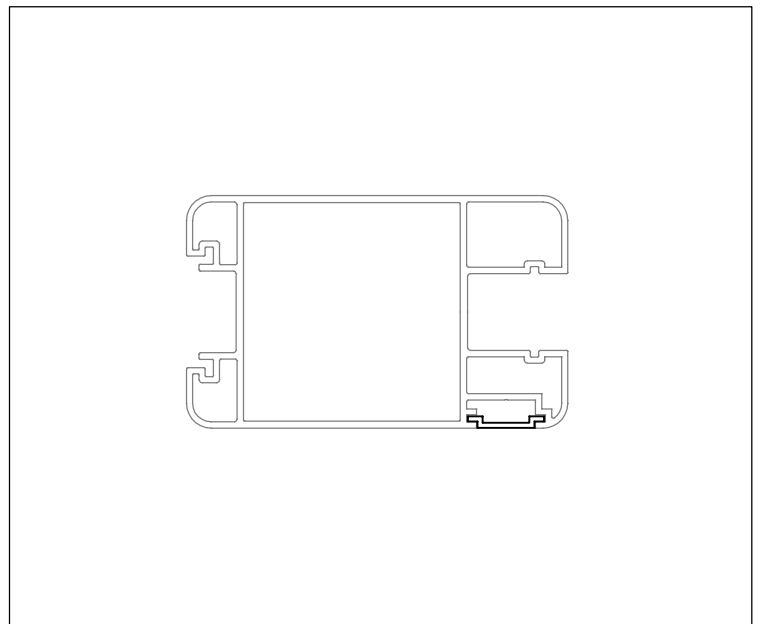
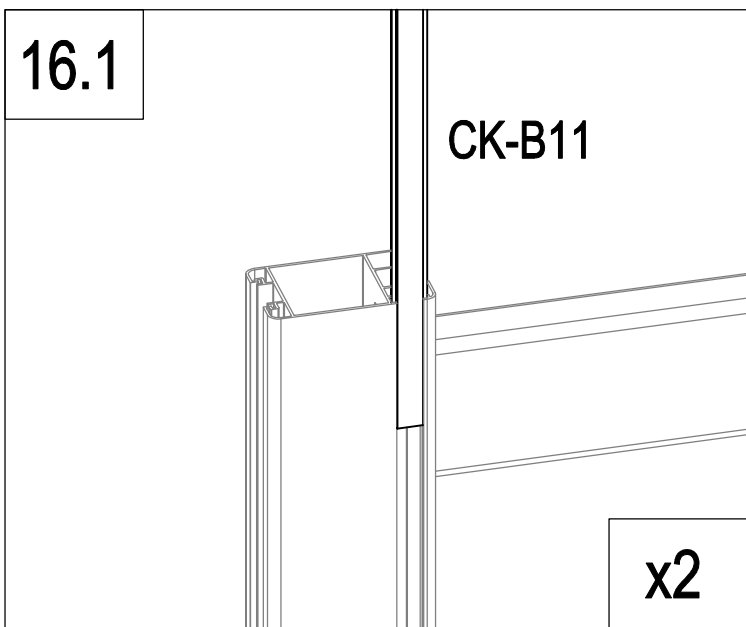
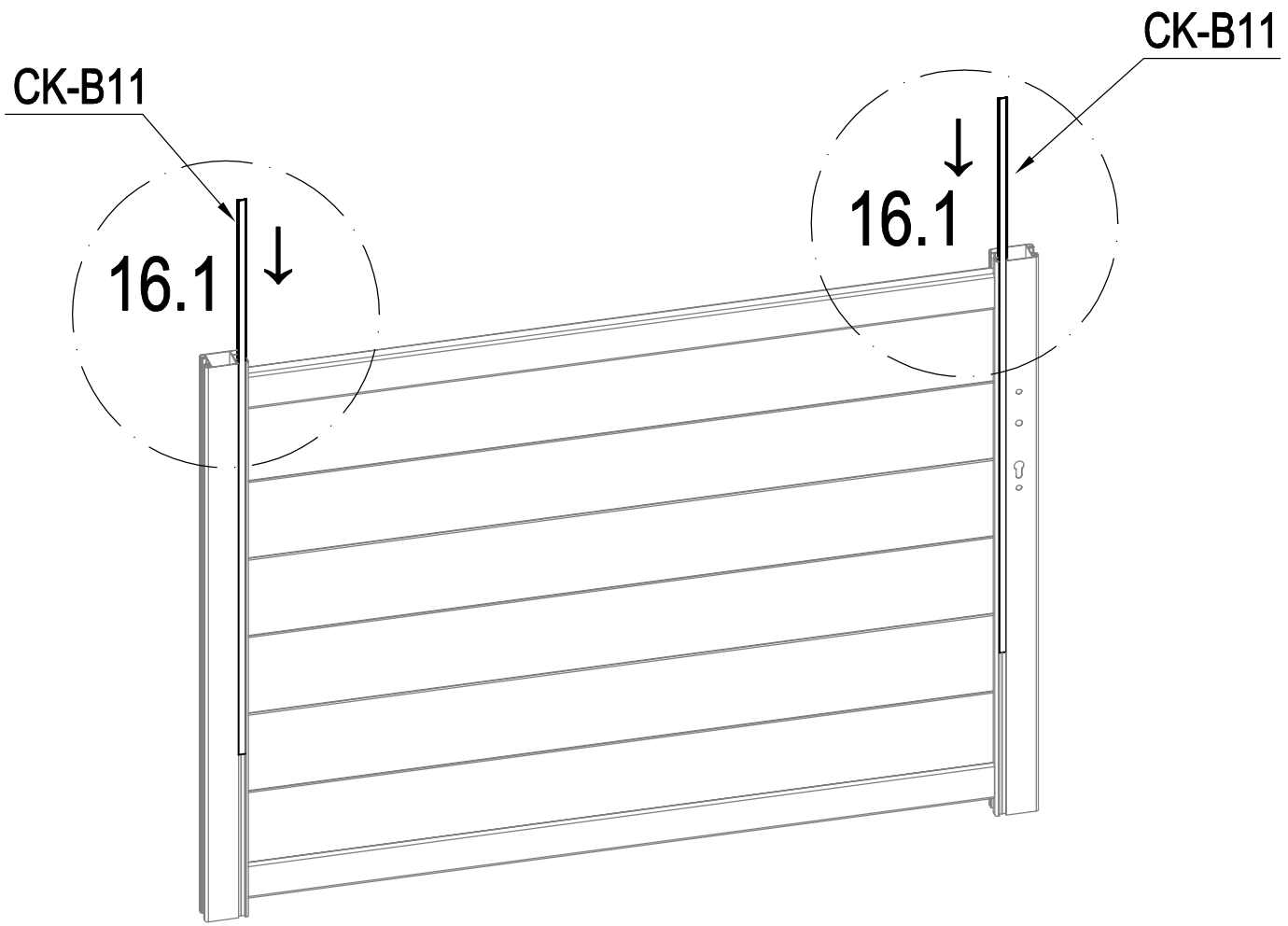

	CK-B11	2
---	--------	---

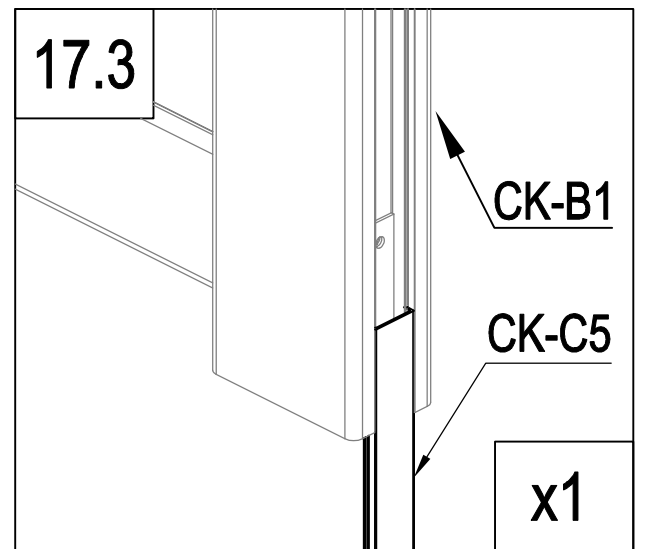
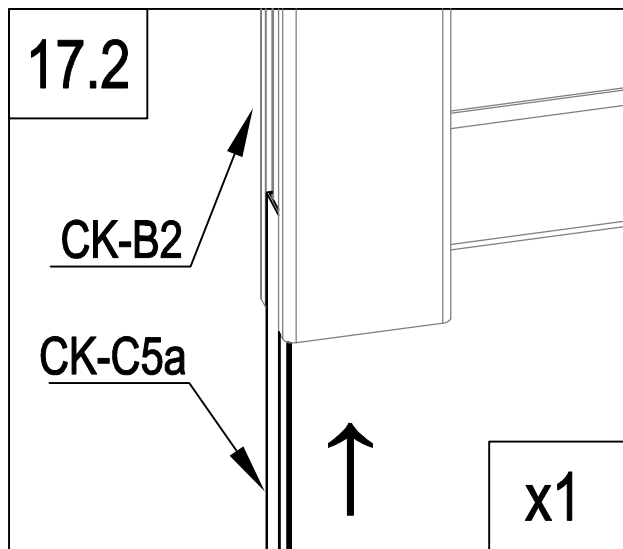
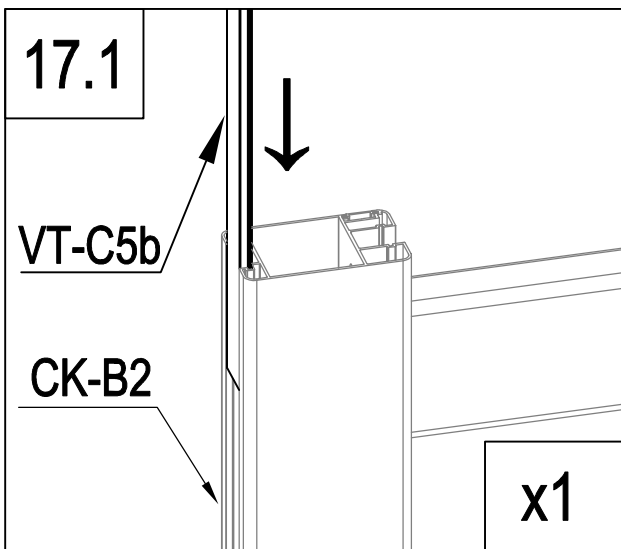
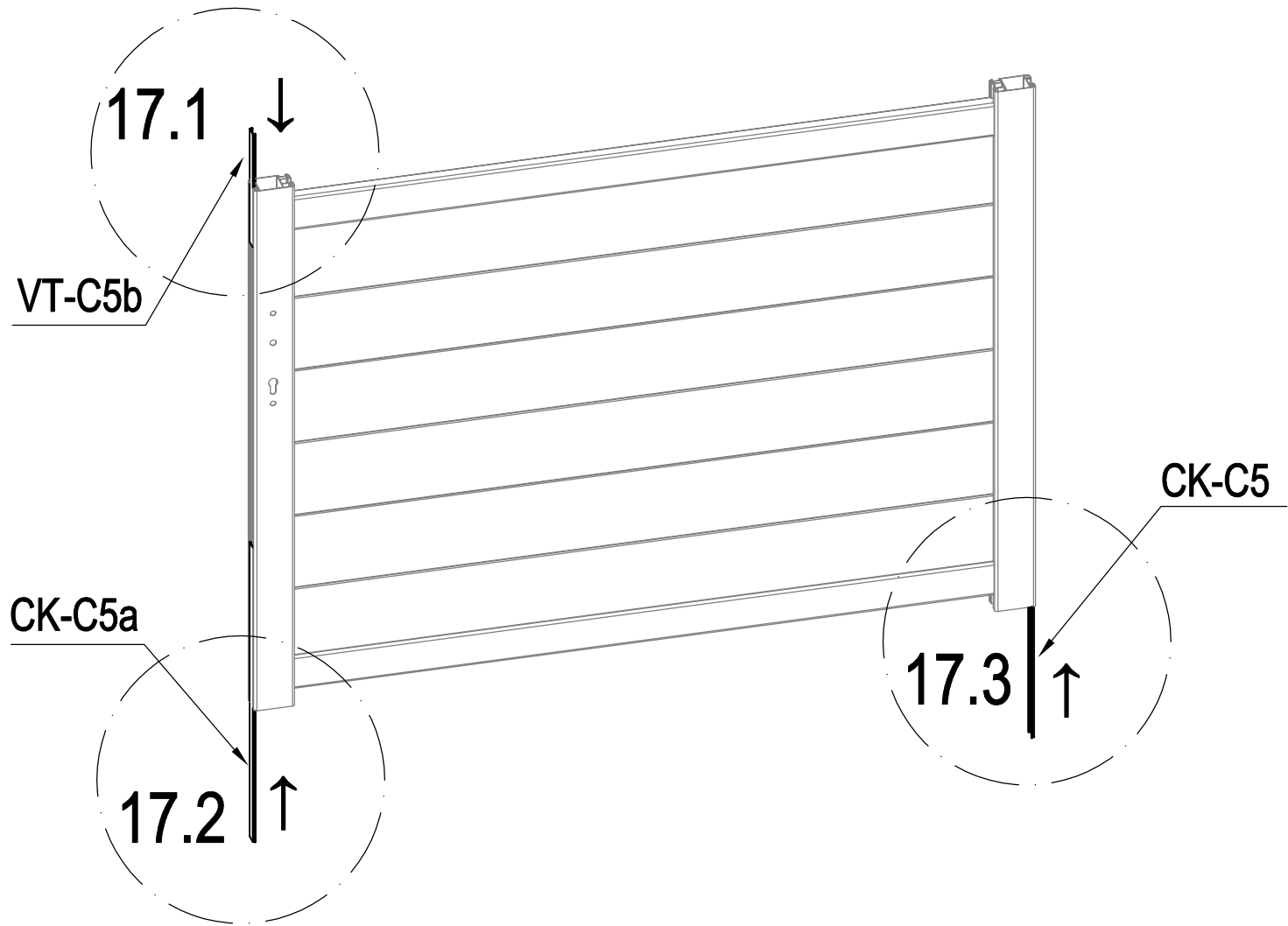
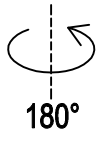

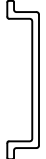
	CK-C5	1
	CK-C5a	1
	VT-C5b	1

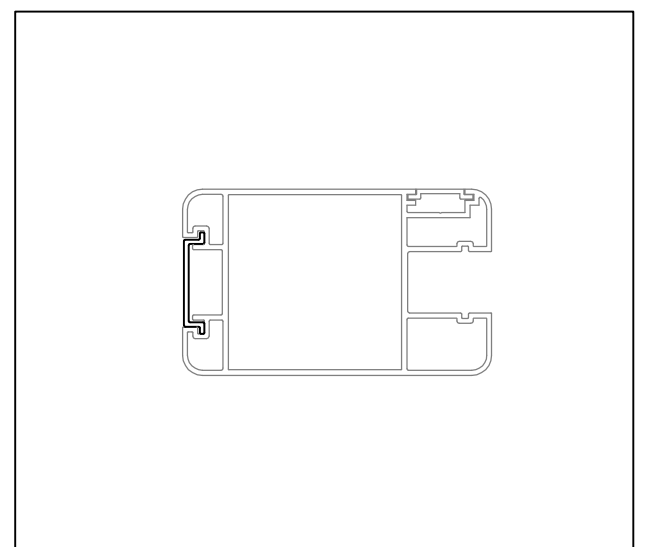

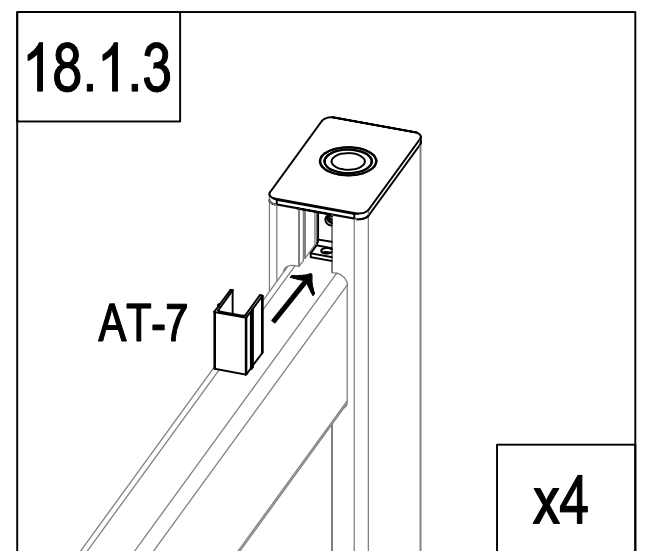
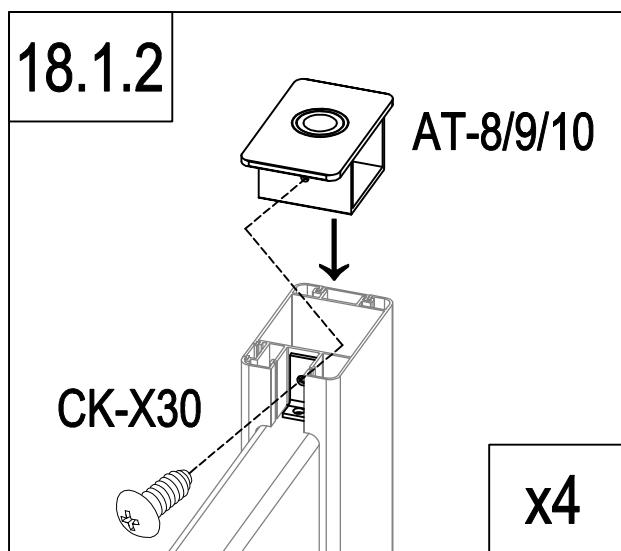
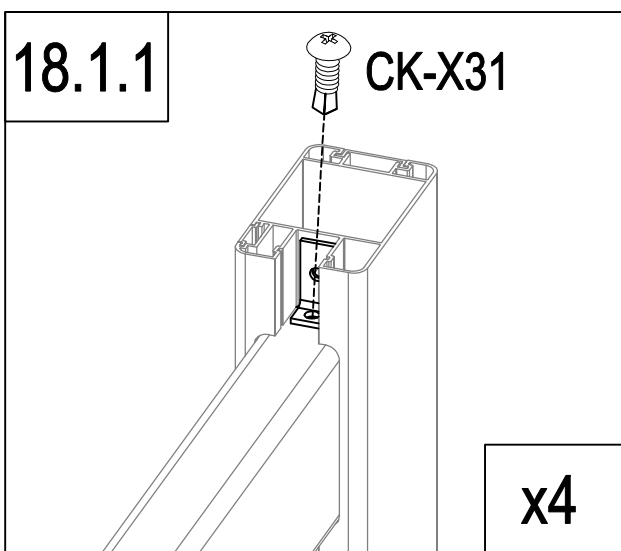
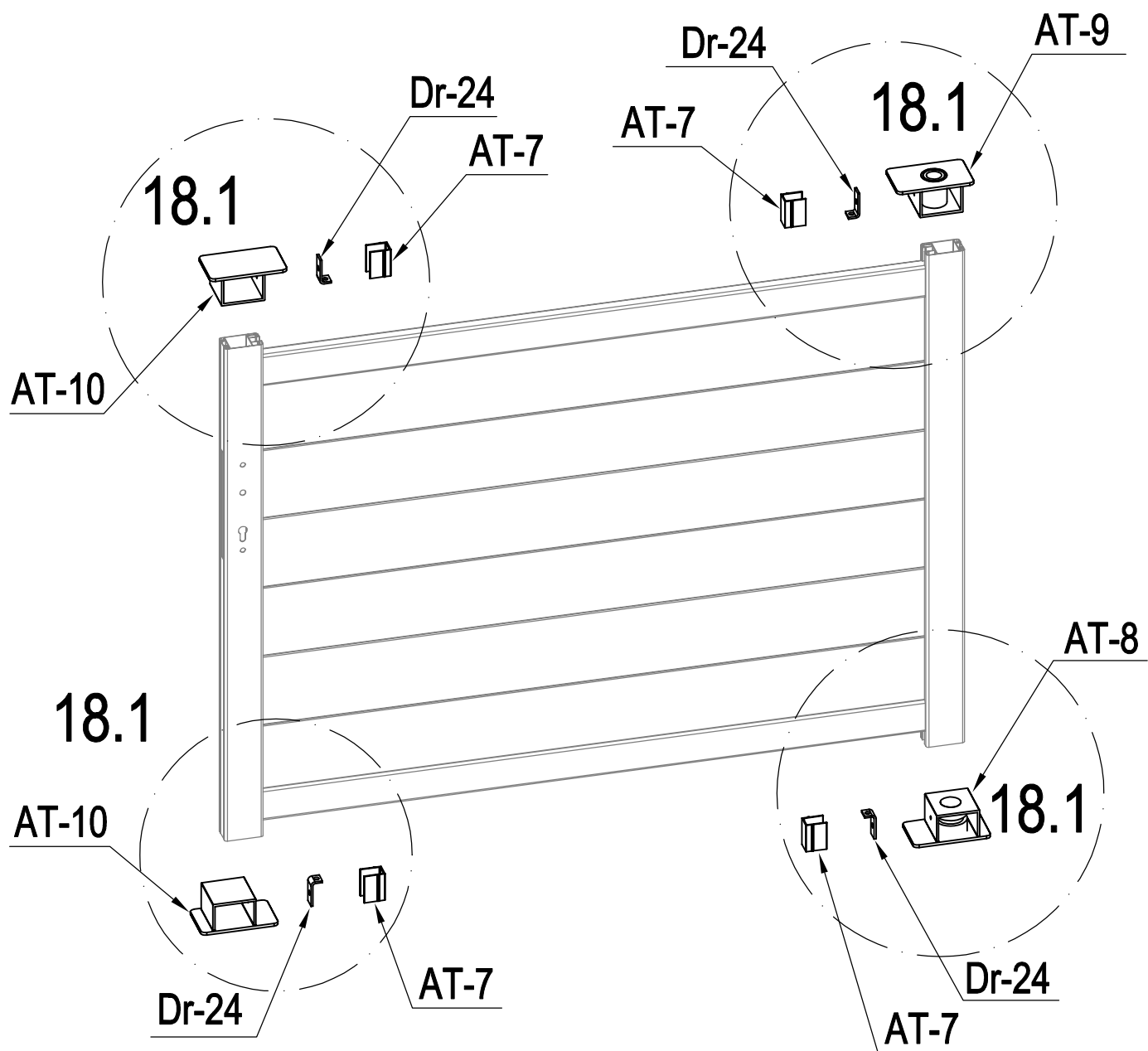

	AT-8	1
	AT-9	1
	AT-10	2
	Dr-24	4

	AT-7	4
	CK-X30	4
	CK-X31	4

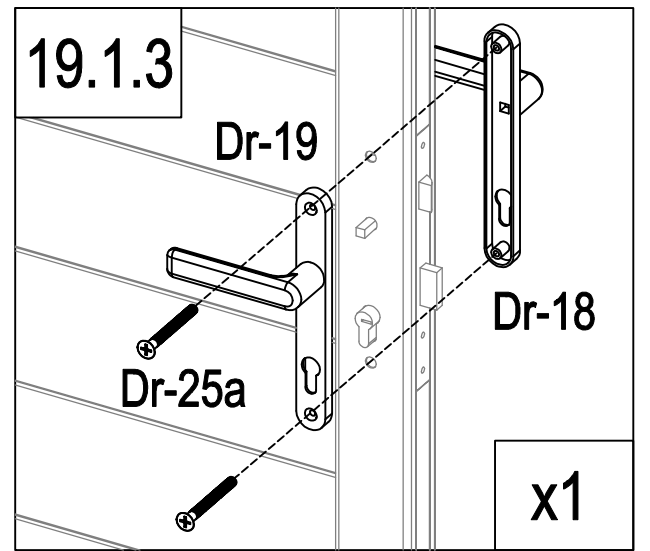
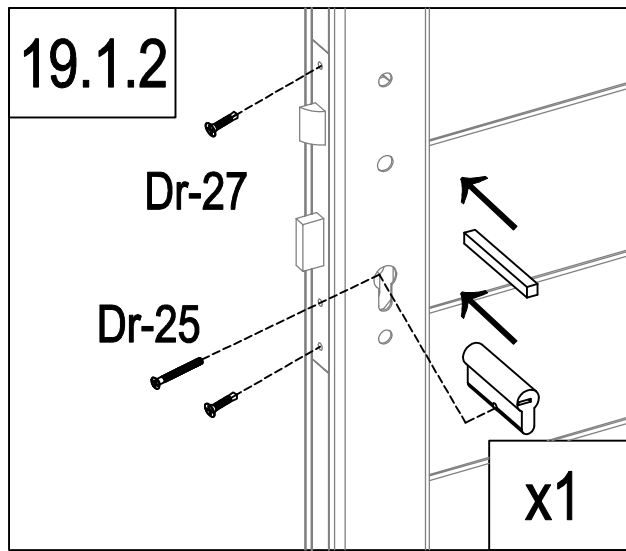
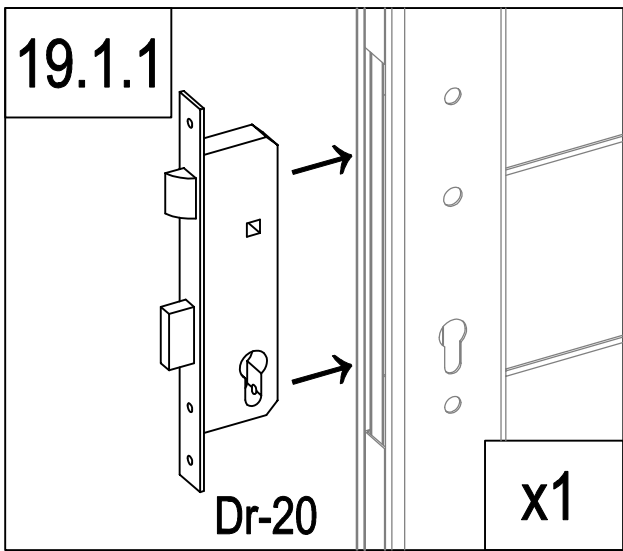
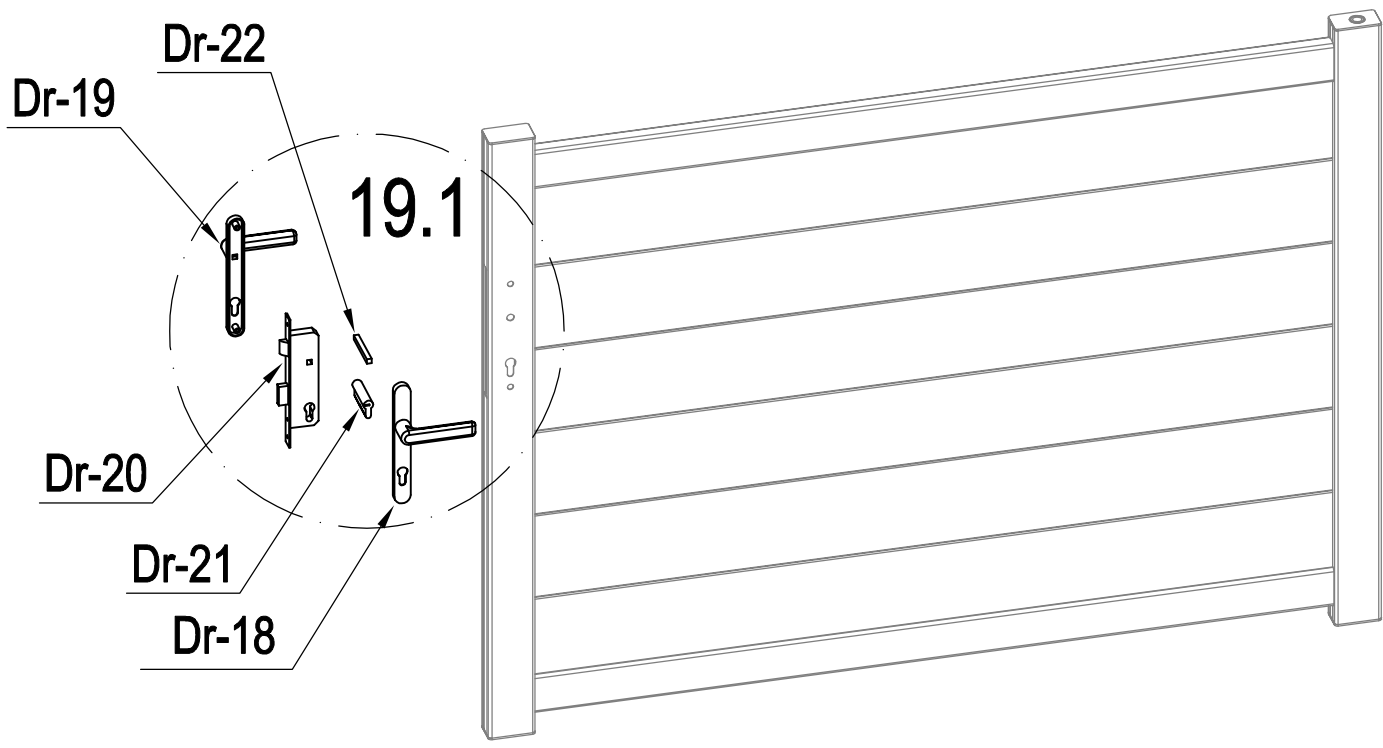

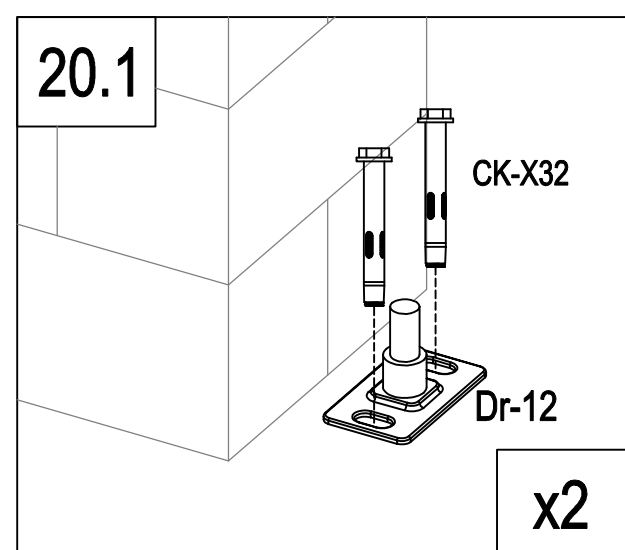
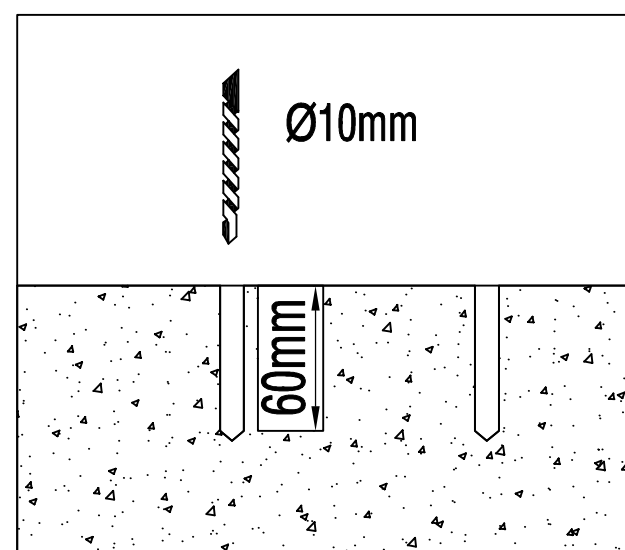
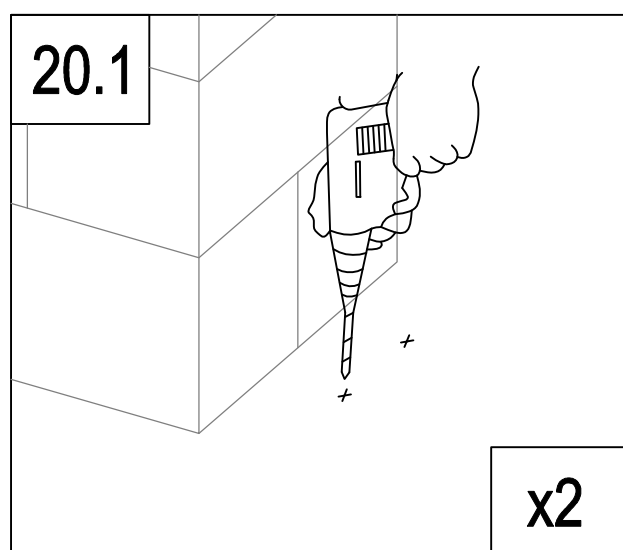
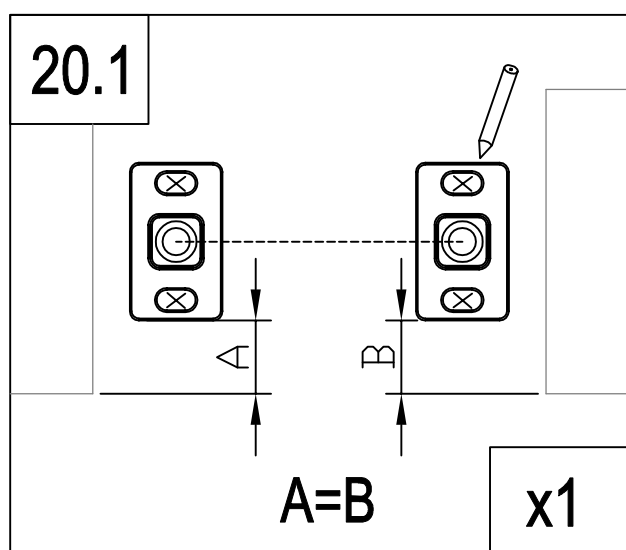
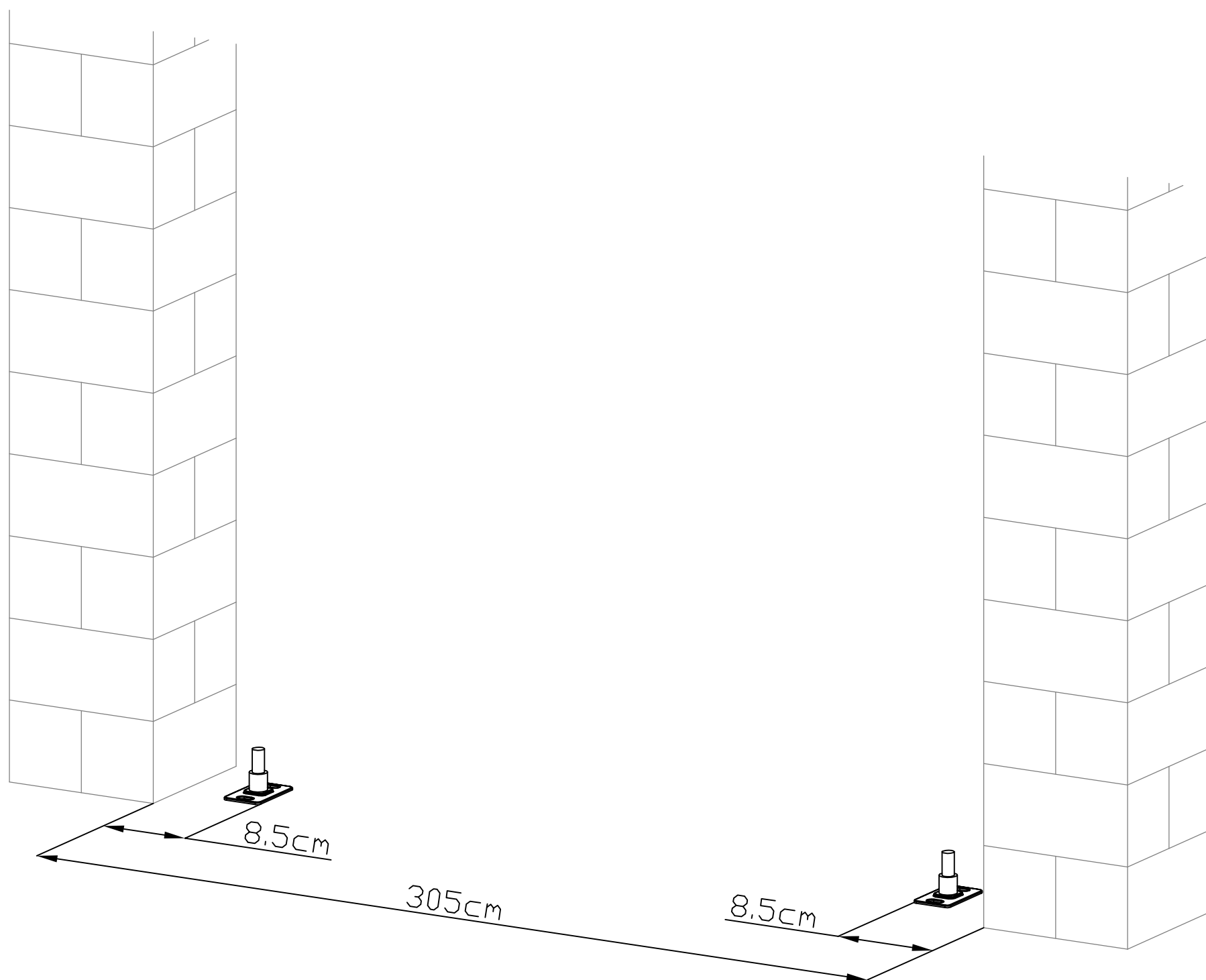

	Dr-20	1
	Dr-21	1
	Dr-22	1
	Dr-25	1

	Dr-18	1
	Dr-19	1
	Dr-25a	2
	Dr-27	2



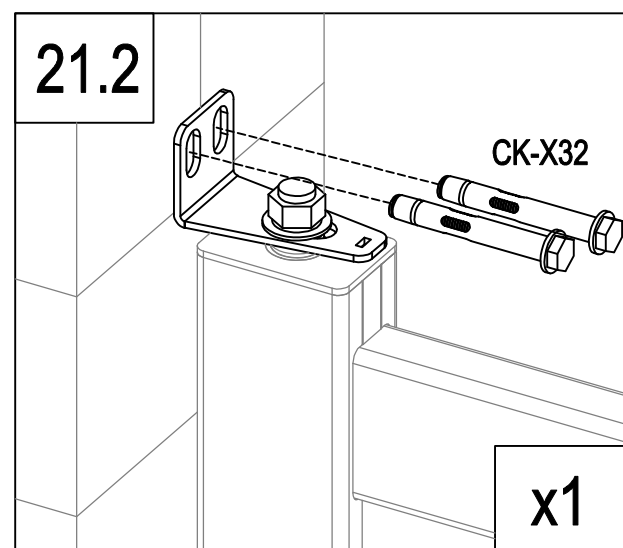
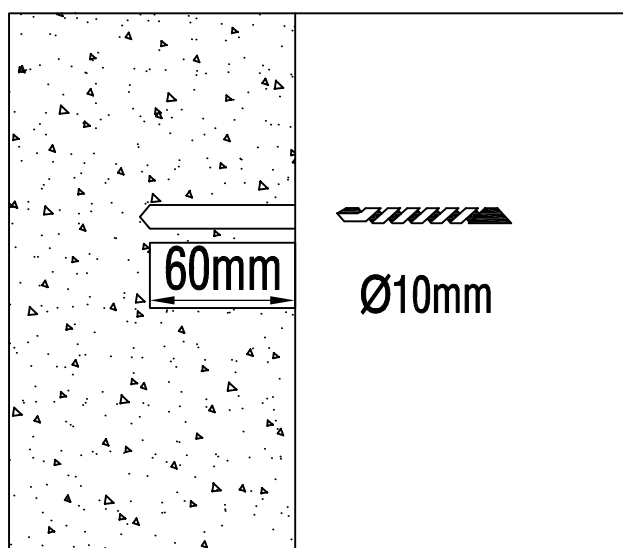
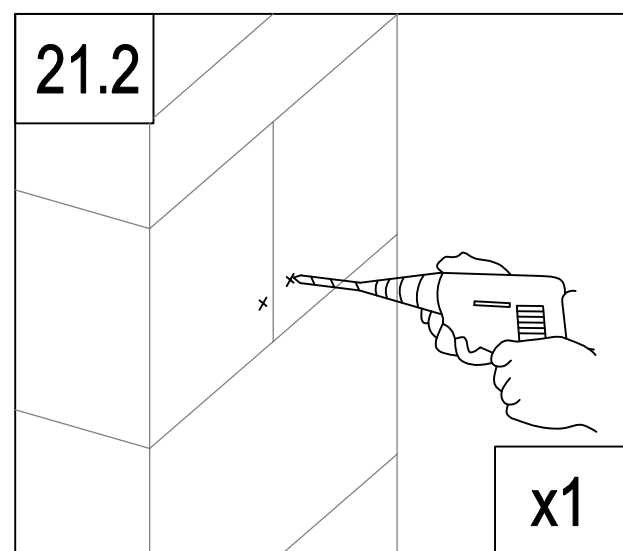
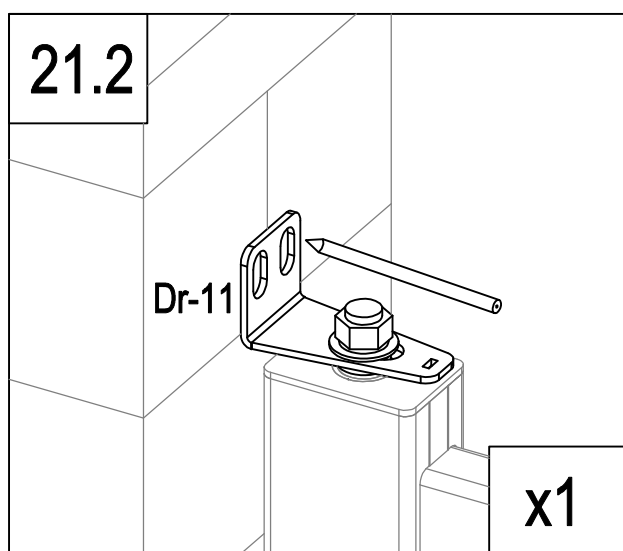
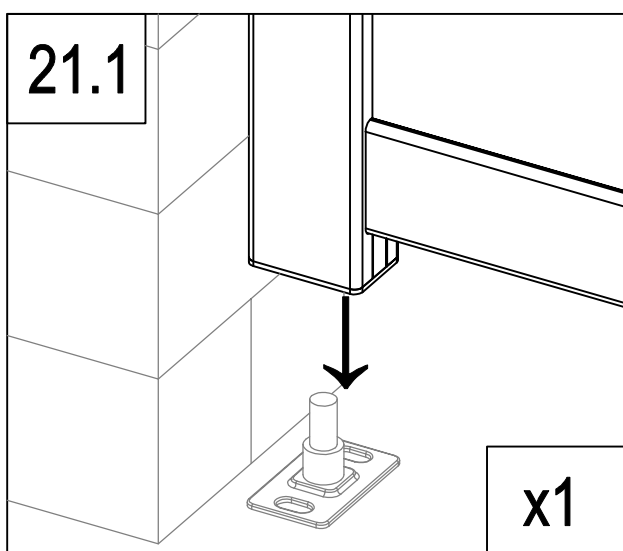
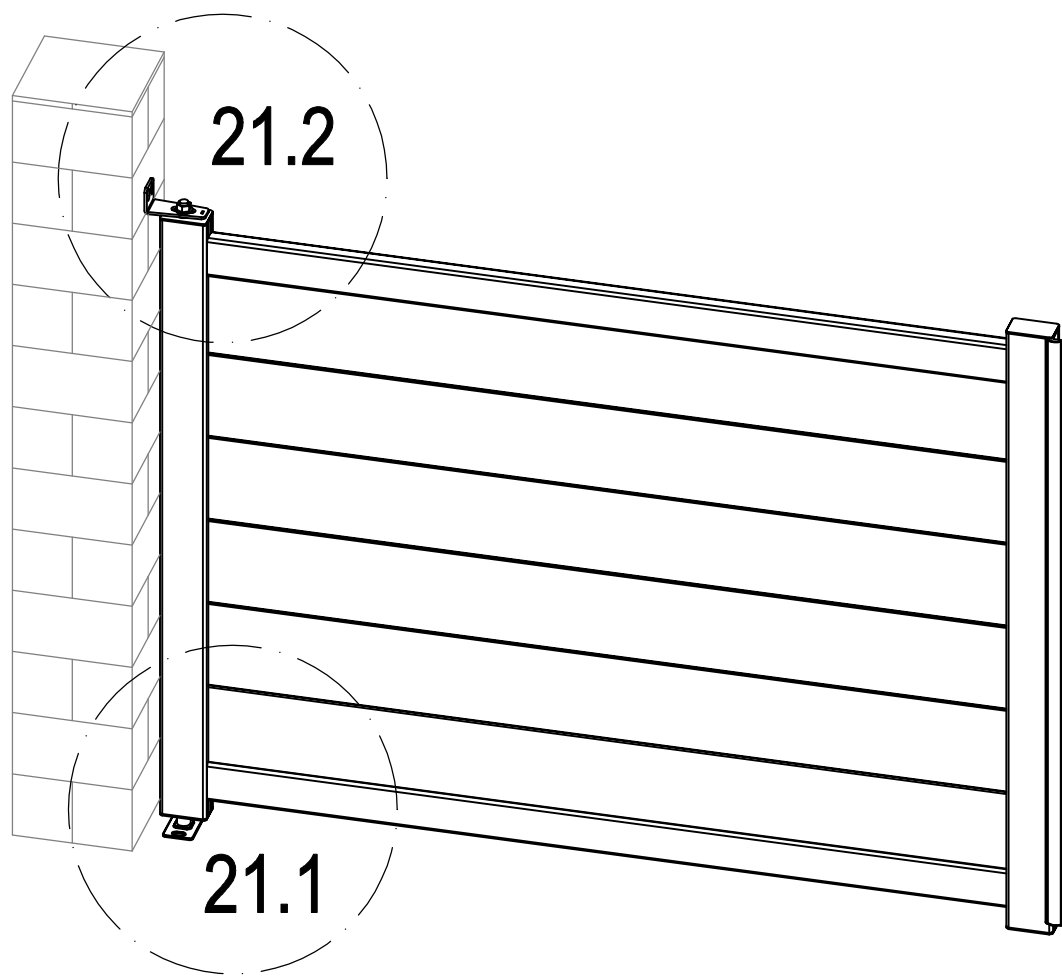

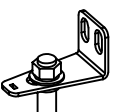
	Dr-12	2
	CK-X32	4



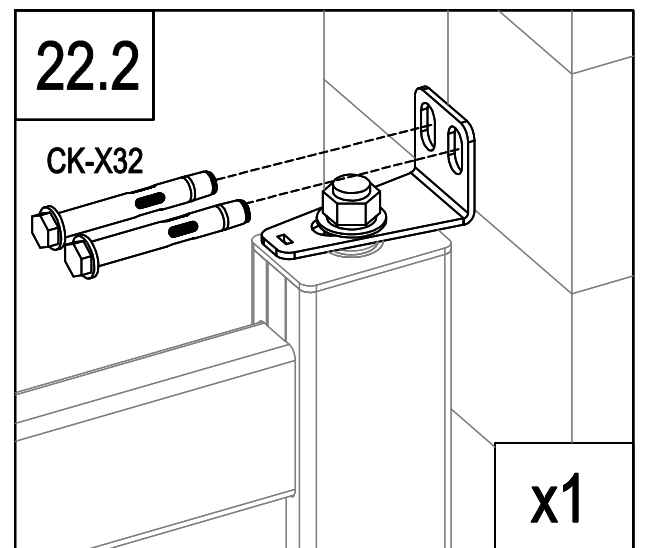
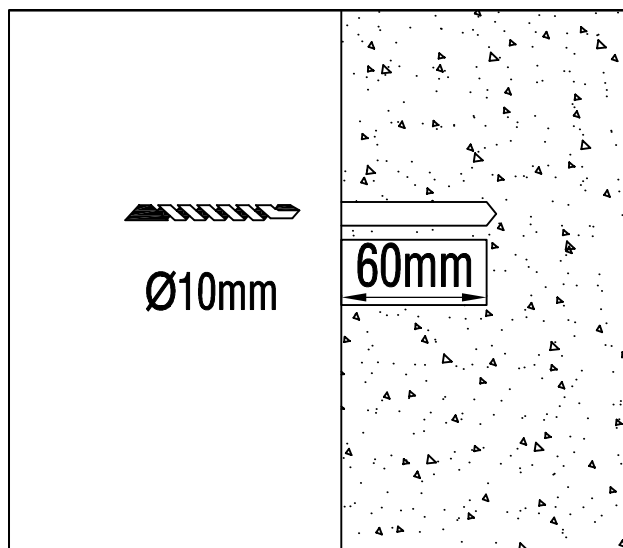
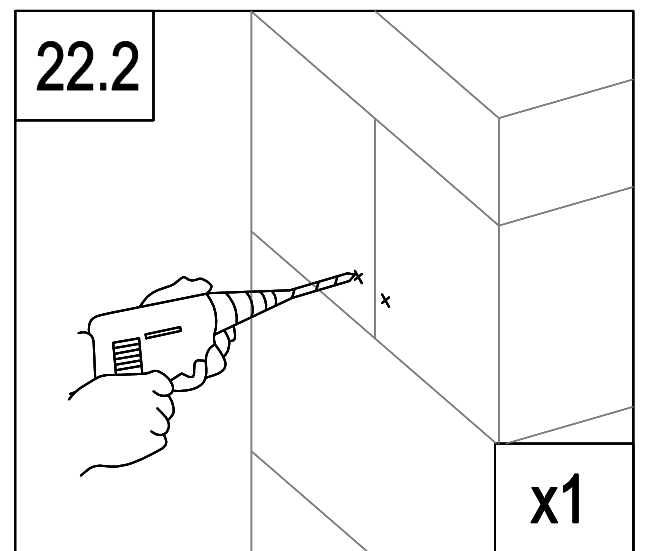
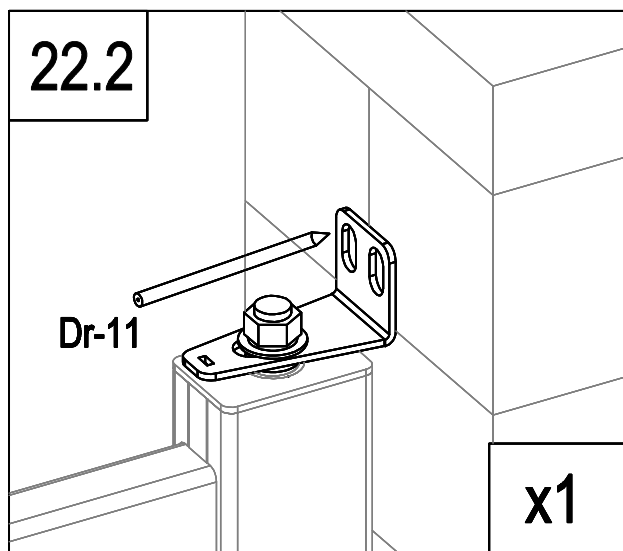
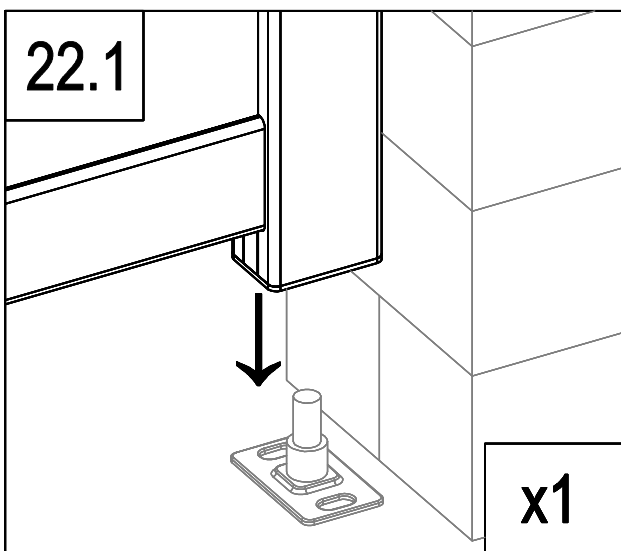
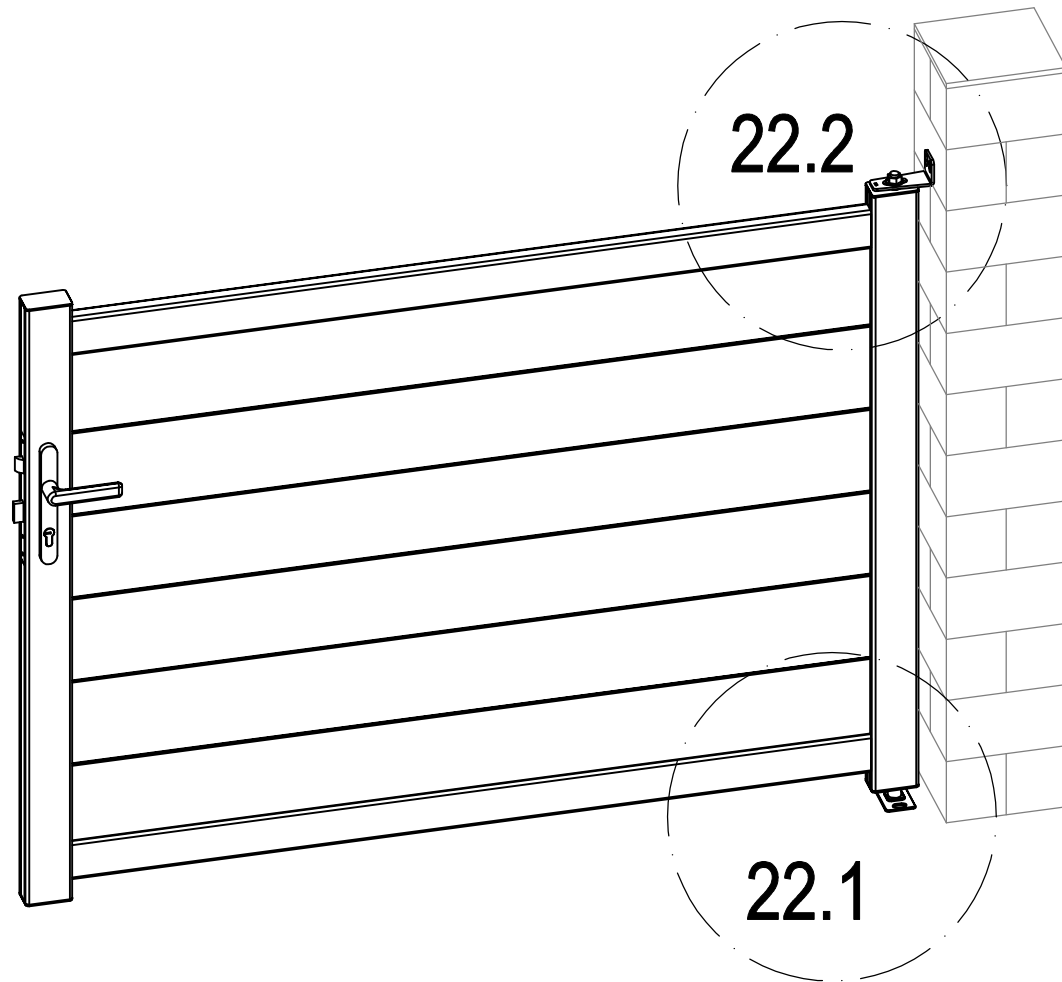

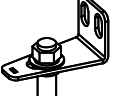
	Dr-11	1
	CK-X32	2



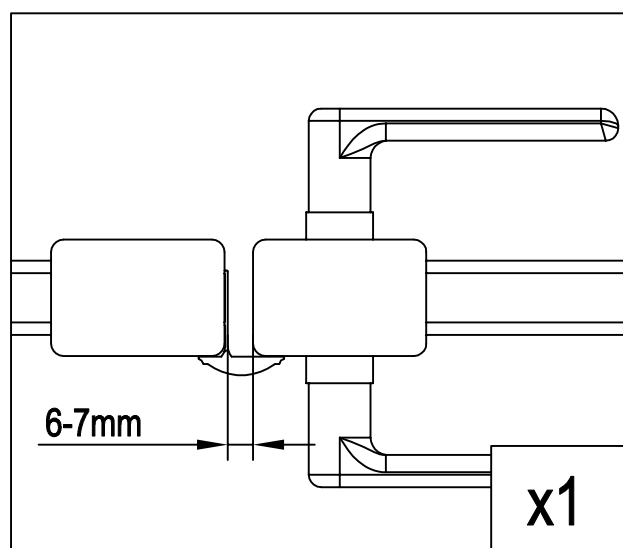
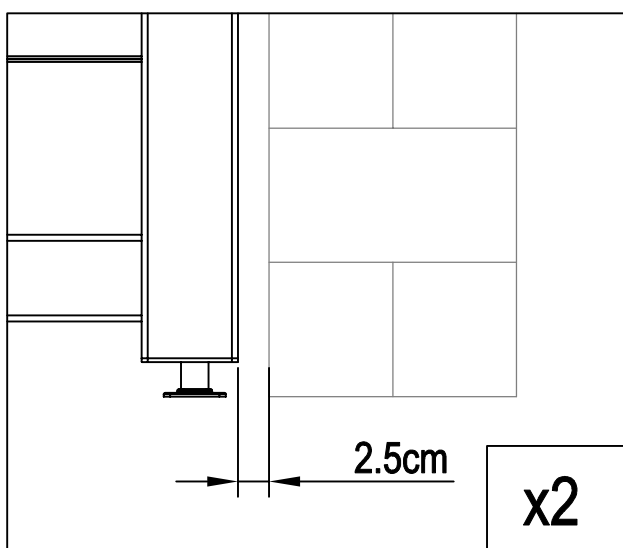
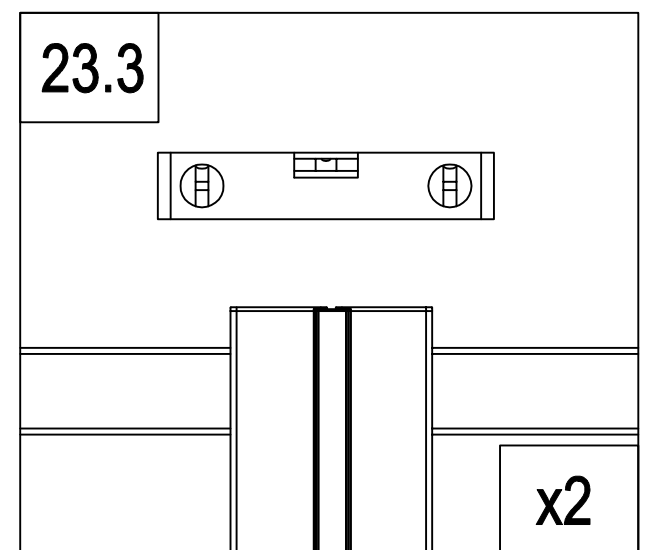
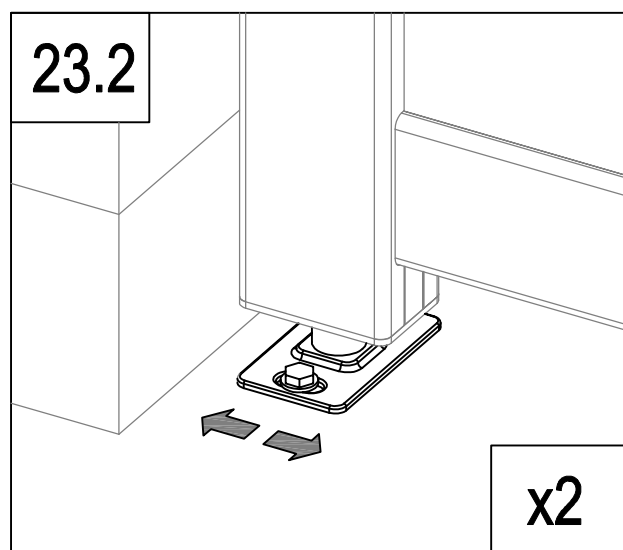
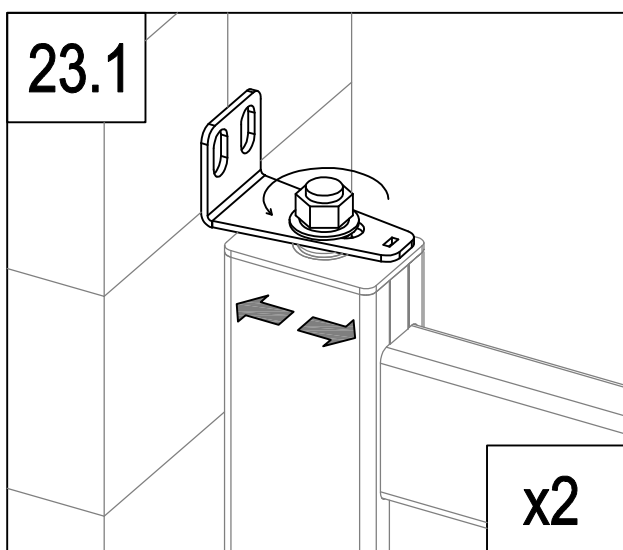
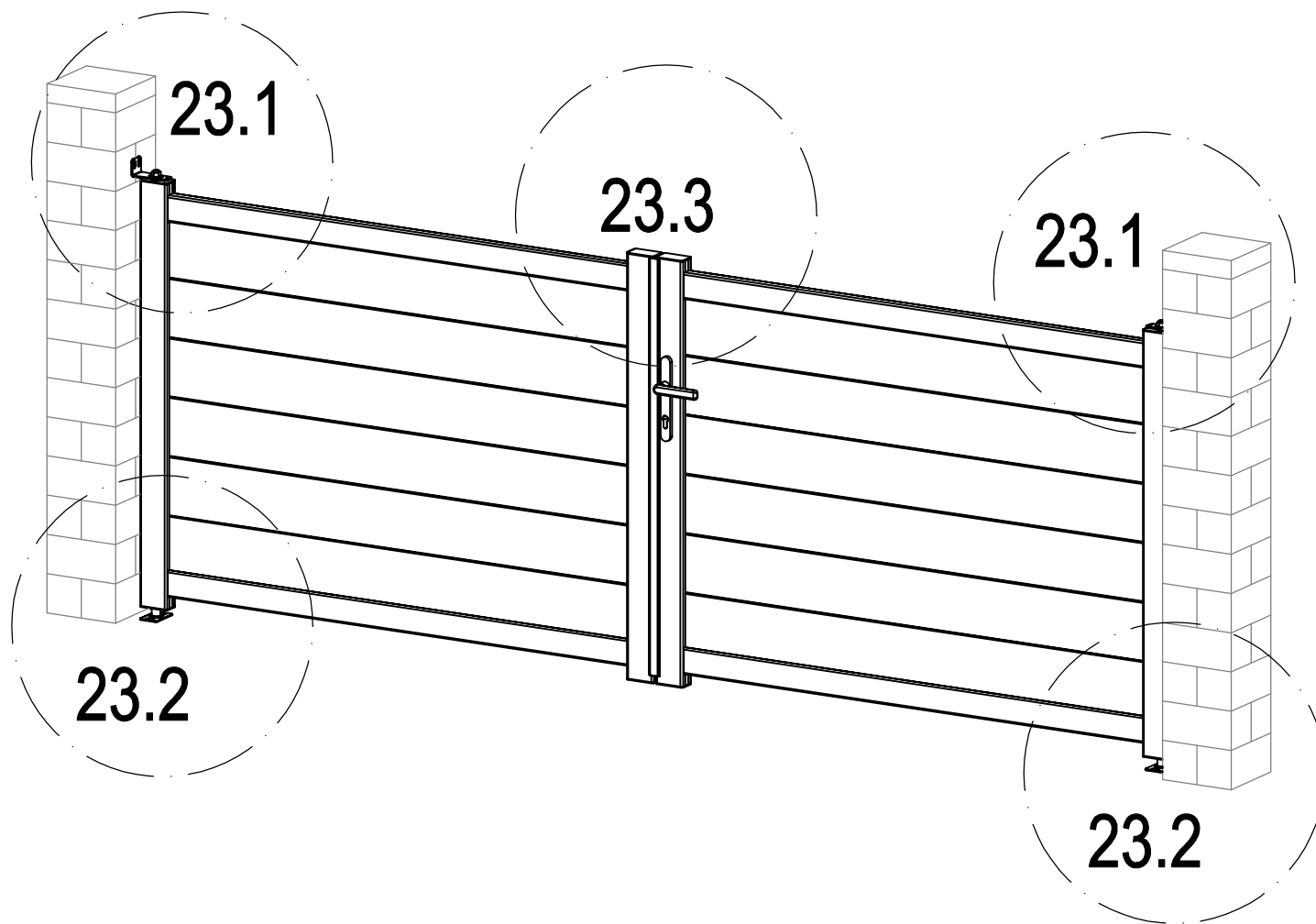

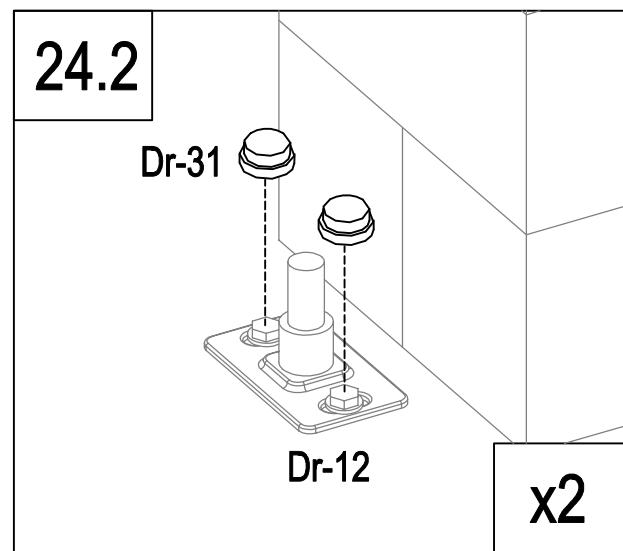
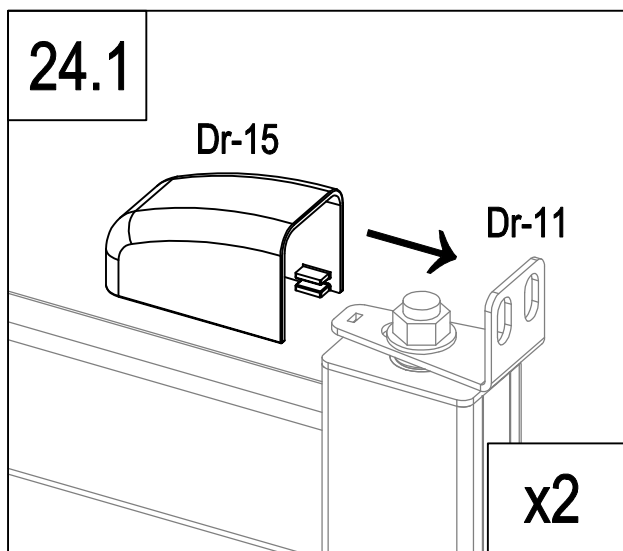
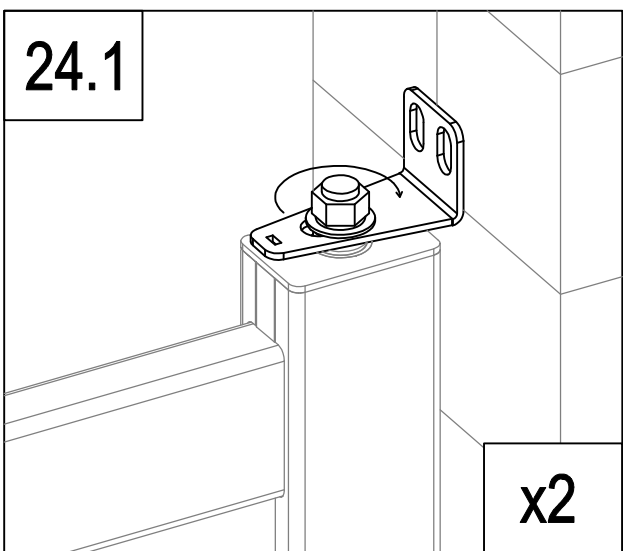
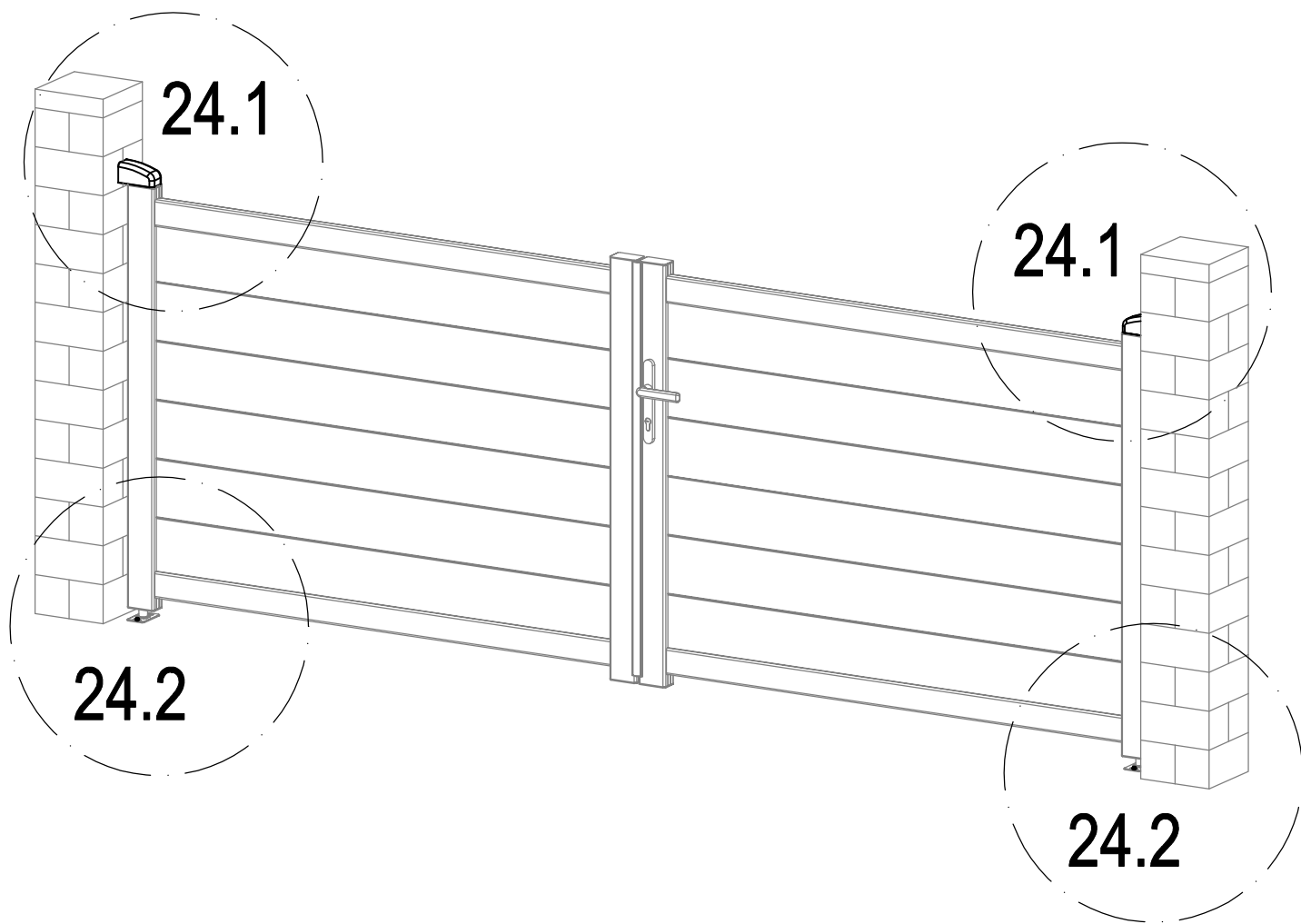
	Dr-11	1
	CK-X32	2

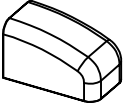



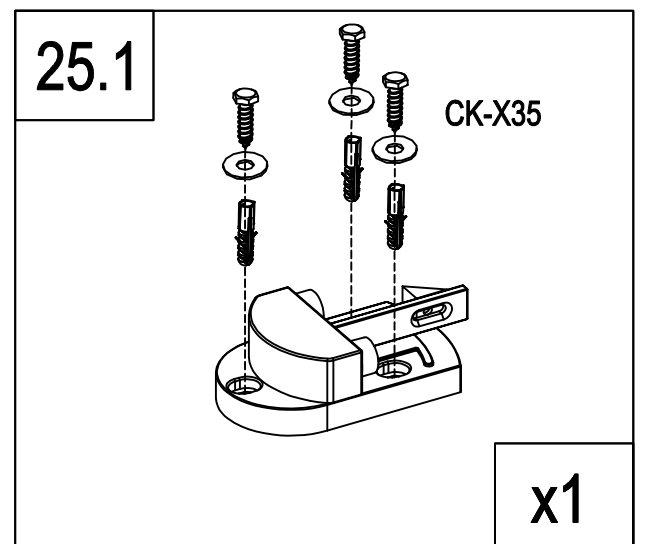
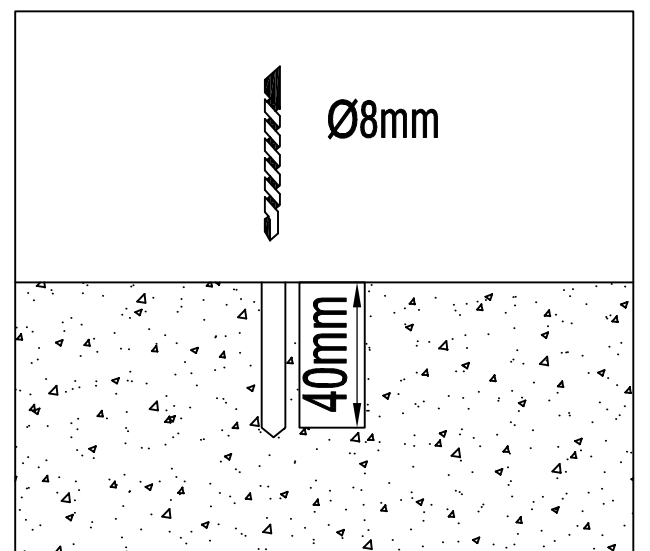
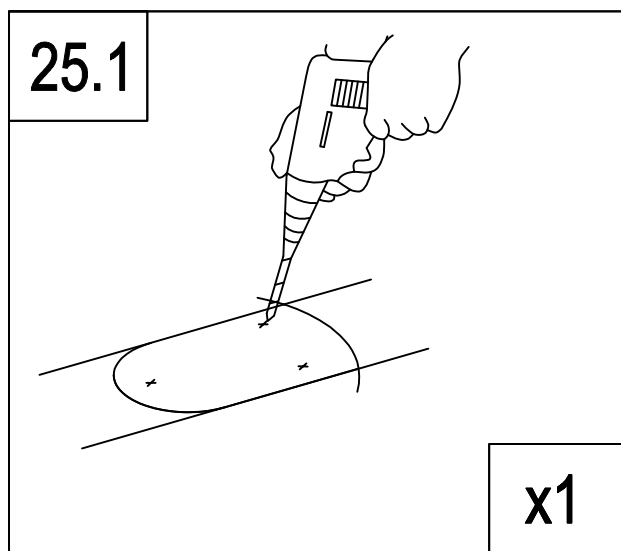
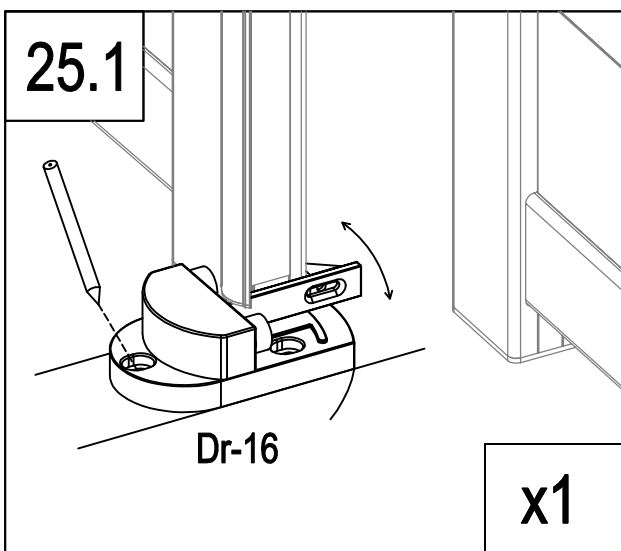
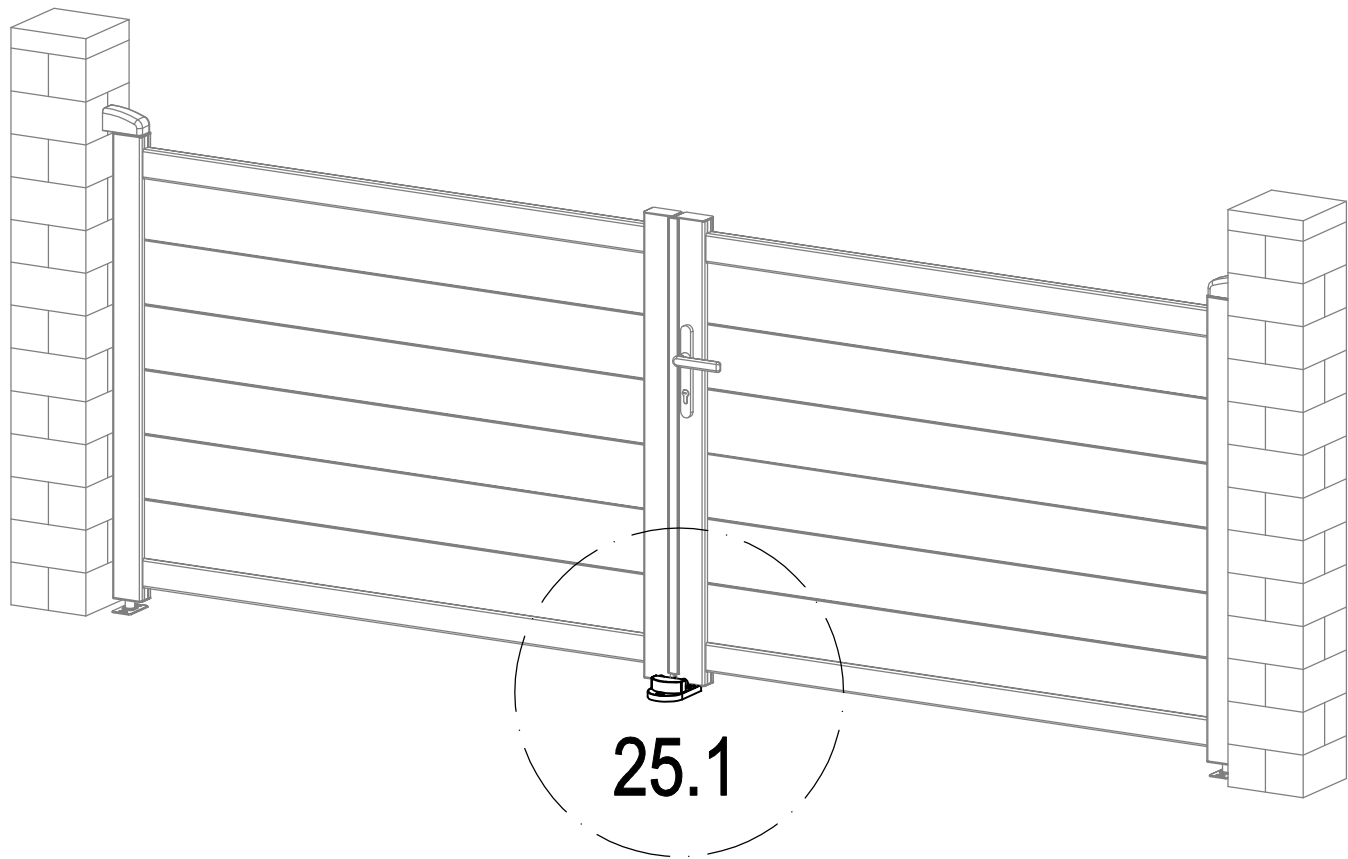

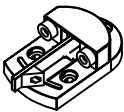
	Dr-15	2
	Dr-31	4

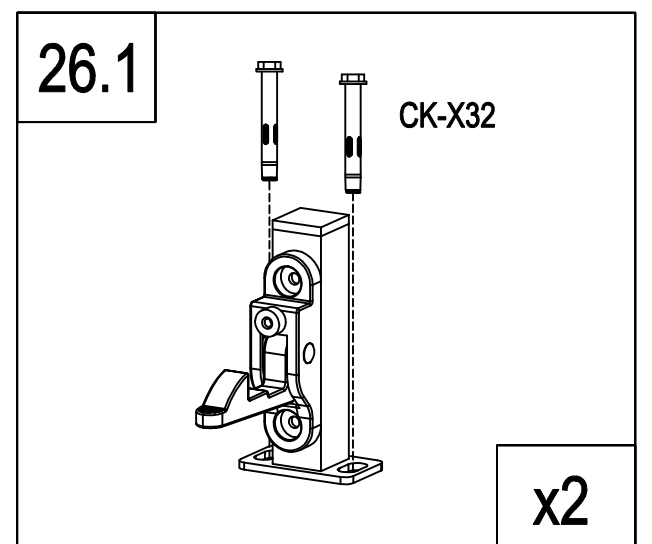
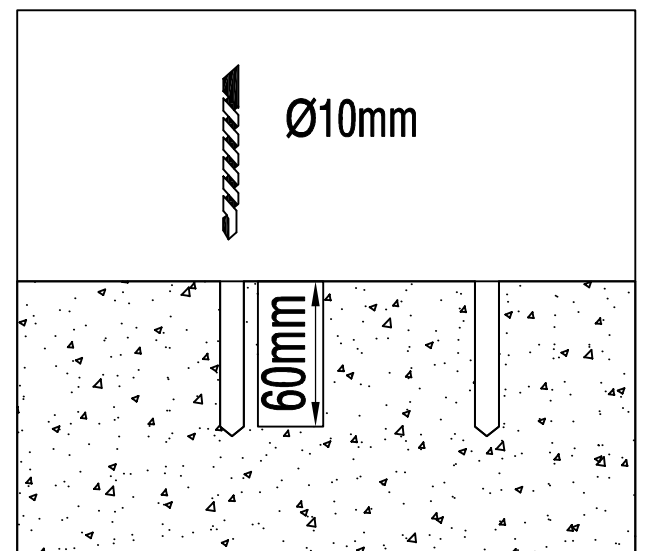
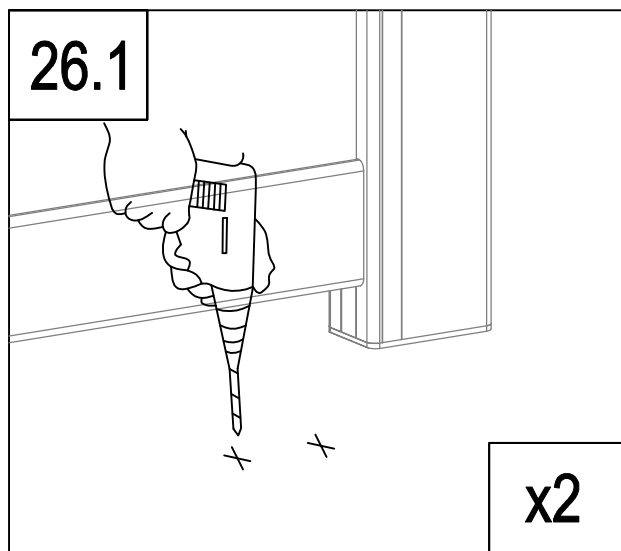
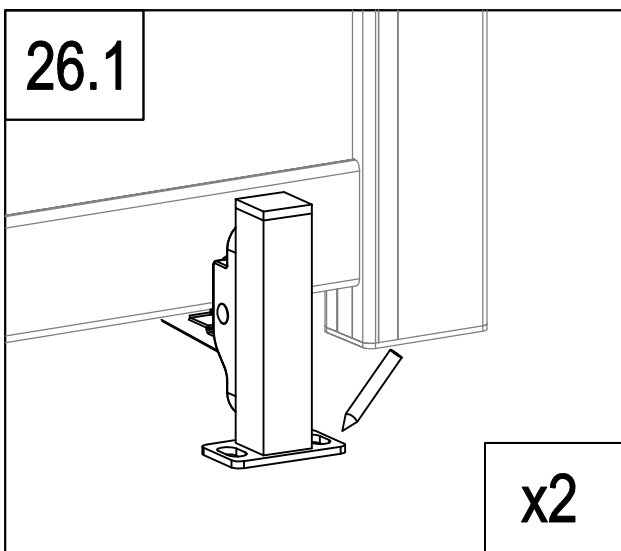
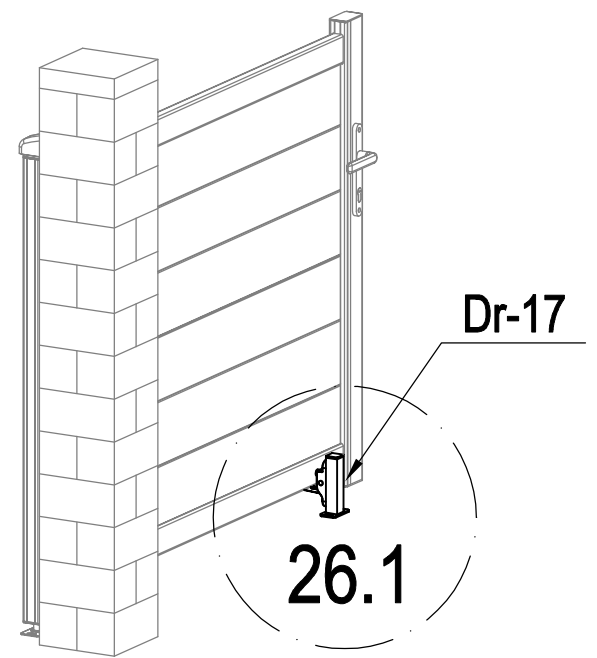
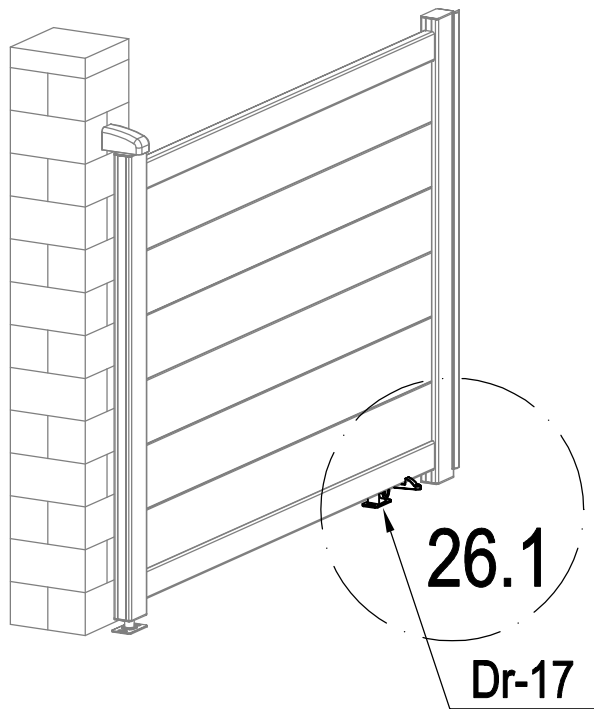

	Dr-16	1
	CK-X34	3
	CK-X35	3



	CK-X32	4
	Dr-17	2