

CASANOVO

ARLBERG 400C160

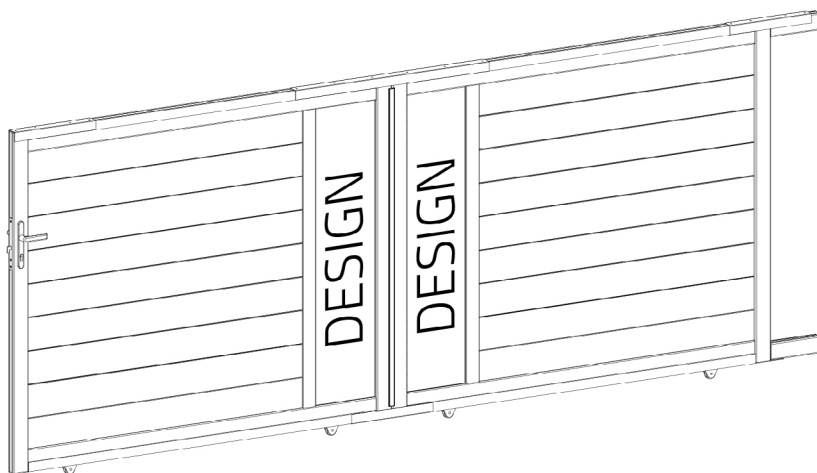

COM-000174 [x1]

COM-000176 [x1]

COM-000175 [x1]

COM-000198 [x1]



INSTRUCTION MANUAL / NOTICE DE MONTAGE / MONTAGEANLEITUNG / MANUAL DE MONTAJE / MANUAL DE MONTAGEM / MANUALE DI MONTAGGIO /
MONTAGEHANDLEIDING / INSTRUKCJA MONTAŻU / KÄYTTÖOHJEET / BRUKSANVISNING / BRUGSANVISNING / INSTRUCIUNI DE ASAMBLARE /
NAVODILA ZA SESTAVLJANJE / NÁVOD NA MONTÁŽ / ÖSSZESZERELÉSI ÚTMUTATÓ / NÁVOD K MONTÁŽI / UPUTE ZA INSTALACIJU /
ΟΔΗΓΙΕΣ ΣΥΝΑΡΜΟΛΟΓΗΣΗΣ / SURINKIMO INSTRUKCIJOS / MONTĀŽAS INSTRUKCIJAS

Ext.

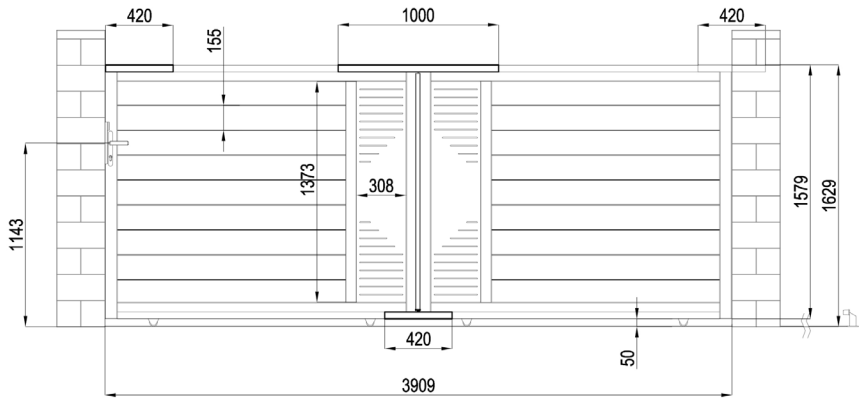

Int.

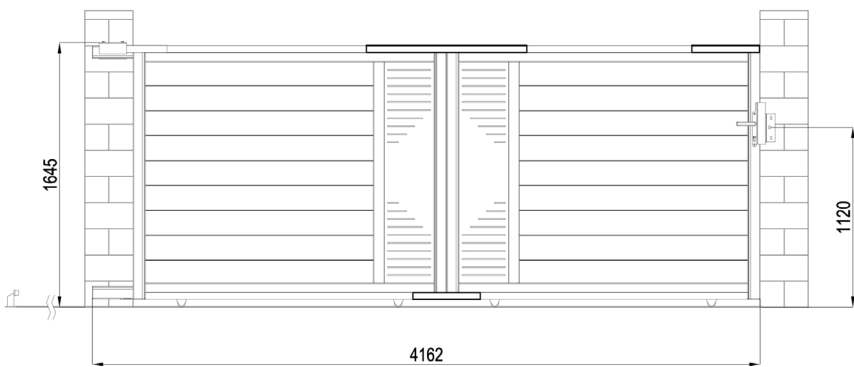

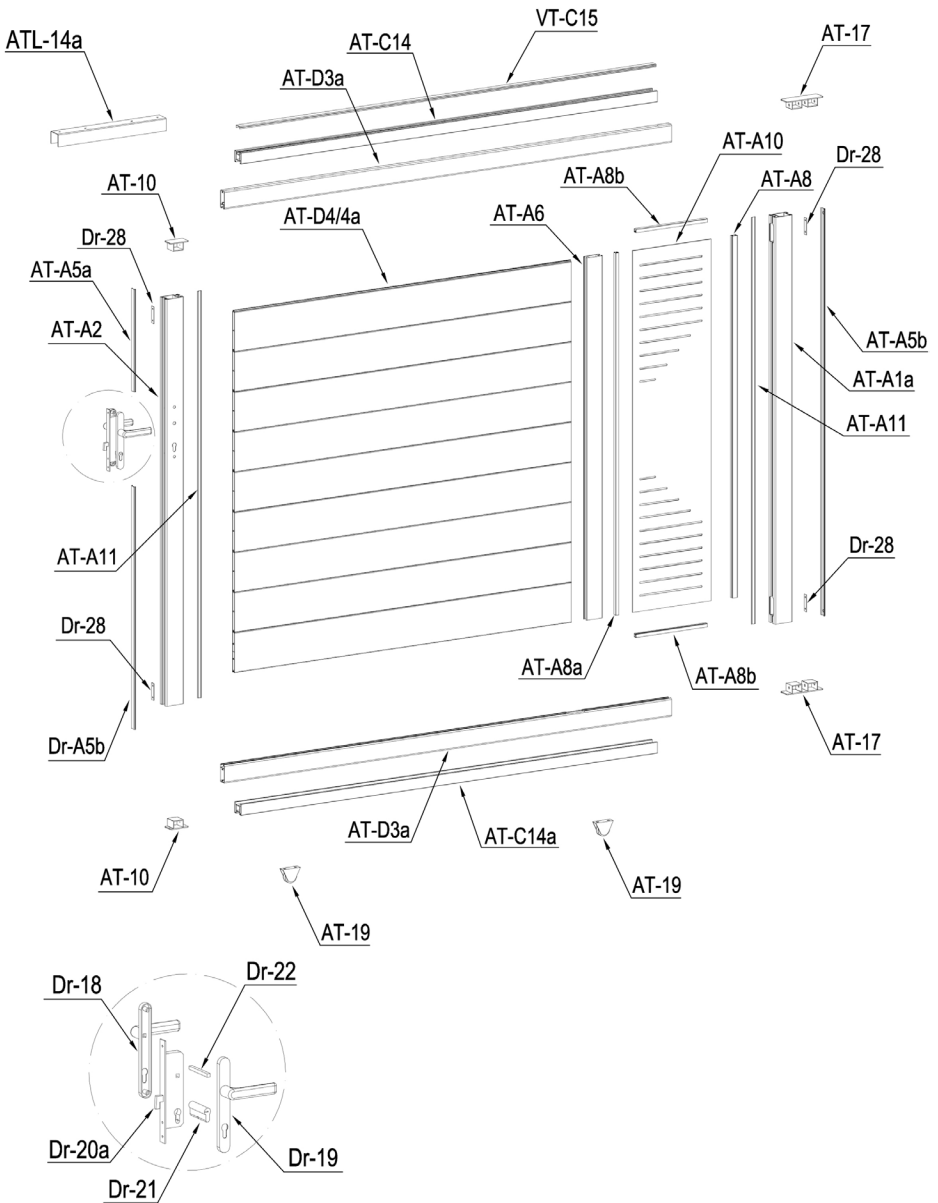

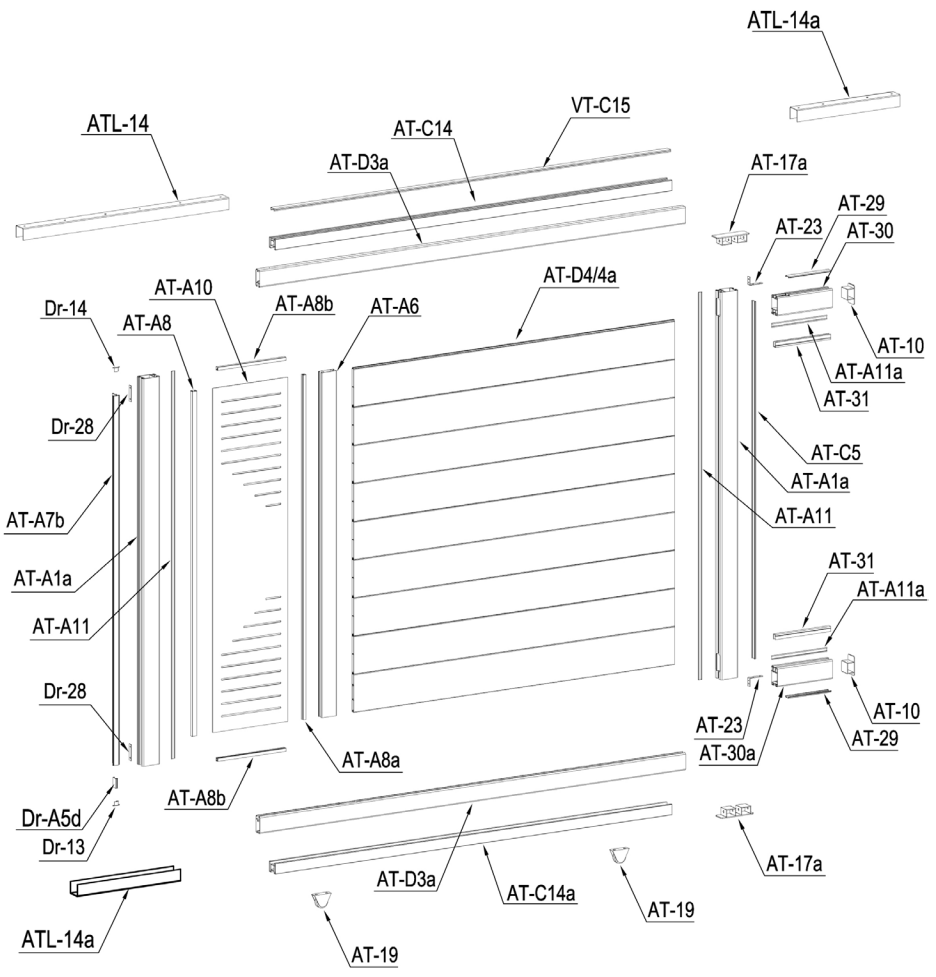

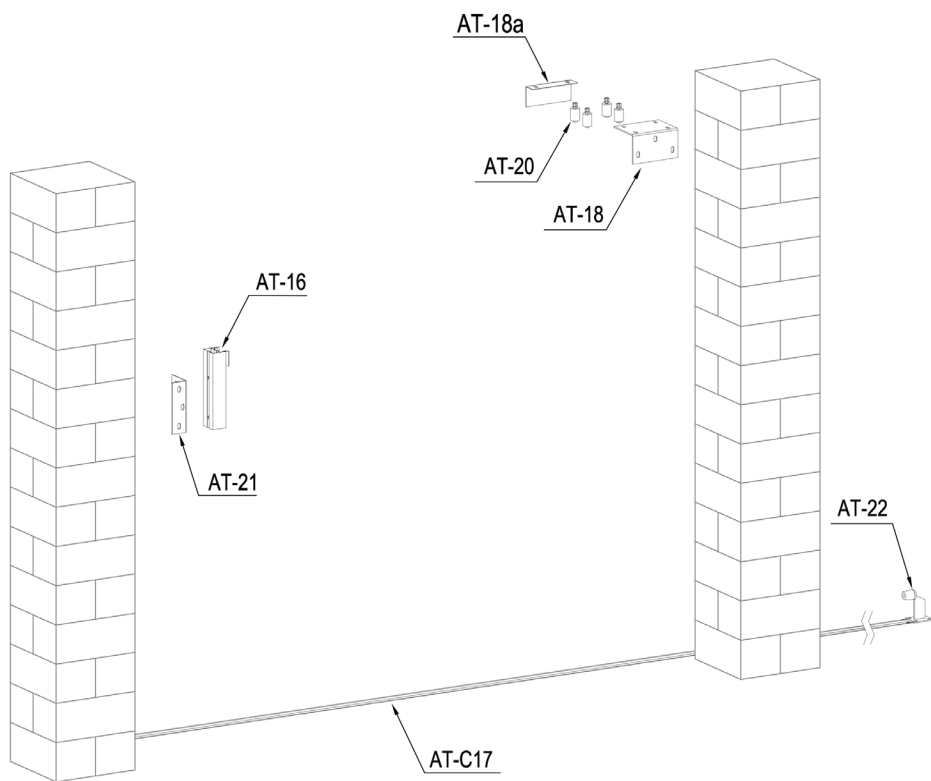



















































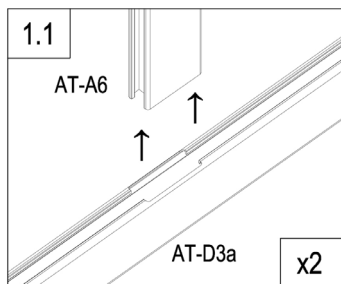
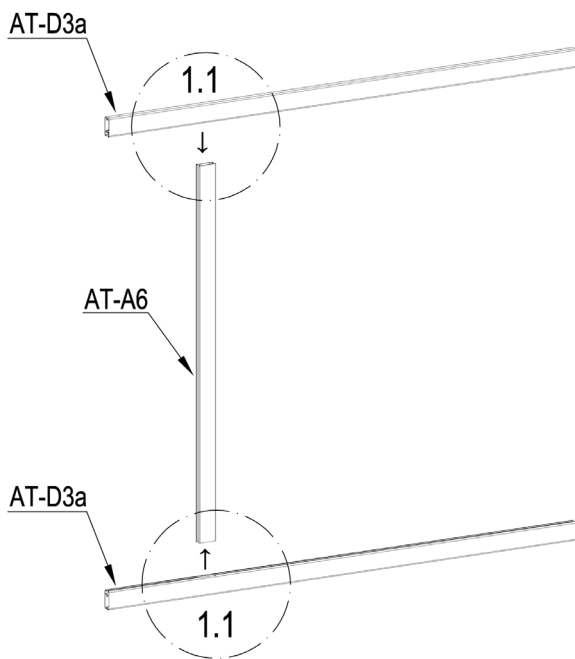

PART LIST

IMAGE	NO.	L.(mm)	QTY	IMAGE	NO.	L.(mm)	QTY
	AT-A1a	1573	3		AT-10		4
	AT-A2	1573	1		Dr-13		1
	AT-30	250	1		Dr-14		1
	AT-30a	250	1		AT-18		1
	AT-D3a	1931	4		AT-18a		1
	AT-D4	1455	16		AT-19		4
	AT-D4a	1455	2		AT-20		4
	AT-A5b	1573	1		AT-21		1
	AT-C5	1448	1		AT-22		1
	AT-A5a	395.5	1		AT-23		2
	Dr-A5b	937	1		Dr-18		1
	AT-29	193	2		Dr-19		1
	Dr-A5d	52	1		Dr-20a		1
	AT-A10	1398	2		Dr-21		1
	AT-A6	1401	2		Dr-22		1
	AT-A8	1400	2		Dr-25		1
	AT-B8a	1400	2		Dr-25a		2
	AT-A8b	308.5	4		Dr-27		2
	AT-A11	1573	4		Dr-28		6
	AT-A11a	250	2		AT-22J		7
	AT-31	250	2		AT-L30		4
	AT-A7b	1468	1		AT-L31		10
	AT-C14	1798	2		AT-L32		32
	AT-C14a	1798	2		AT-L33		4
	VT-C15	1797	2		AT-L34		81
	AT-16	260	1		AT-L35		6
	AT-C17	1580	5		AT-L36		2
	ATL-14	1000	1		AT-L37		8
	ATL-14a	420	3		AT-L38		50
	AT-17		2		AT-L39		8
	AT-17a		2				



	AT-A6	1
	AT-D3a	2

EN :you can flip and switch the direction of this plate to personalize your gate

FR: vous pouvez retourner et changer la direction de cette plaque pour personnaliser votre portail

DE: Sie können dieses Schild umdrehen und die Richtung wechseln, um Ihr Tor zu personalisieren.

ES: puedes girar y cambiar la dirección de esta placa para personalizar tu puerta

PT: pode virar e mudar a direção desta placa para personalizar o seu portão

IT: potete capovolgere e cambiare la direzione di questa piastra per personalizzare il vostro cancello

NL: u kunt de richting van deze plaat omdraaien en veranderen om uw poort te verpersoonlijken...

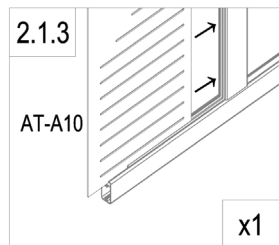
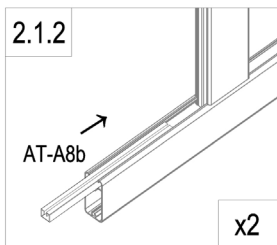
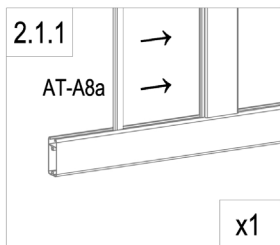
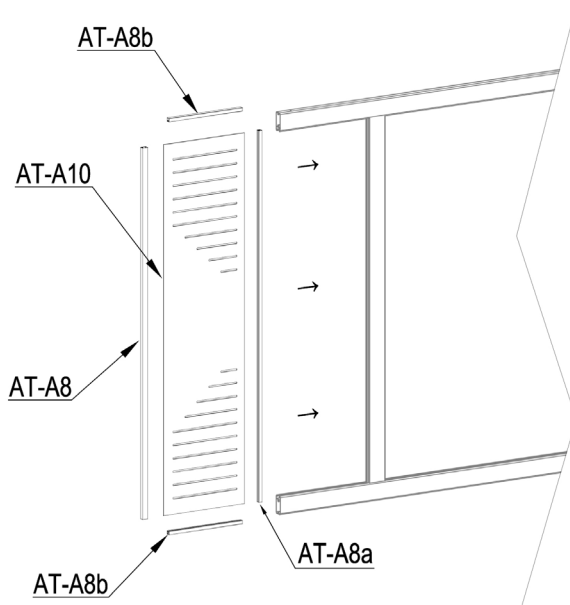

PL: można obrócić i przelączyć kierunek tej płyty, aby spersonalizować bramę.



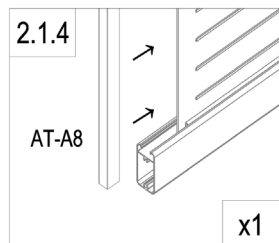

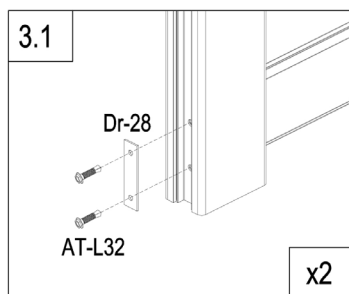
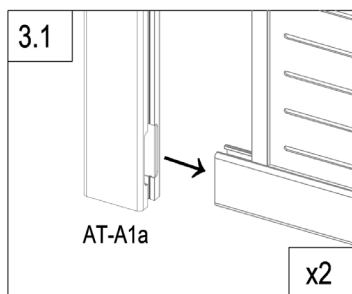
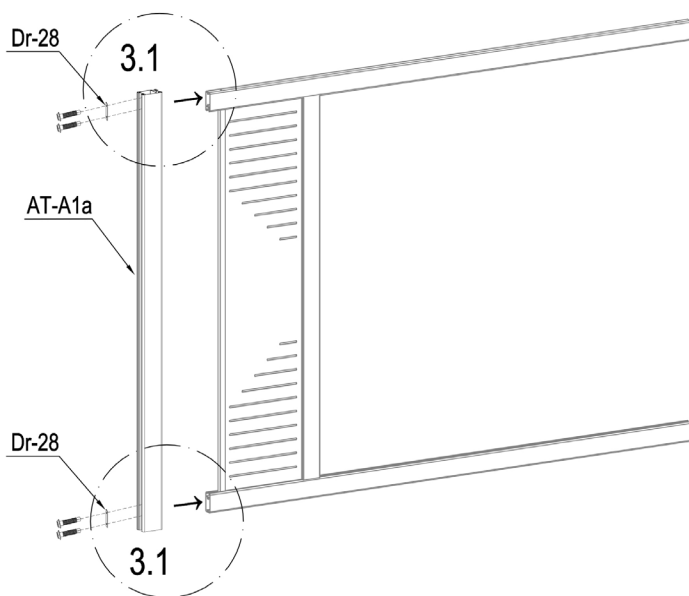
	AT-A8a	1
	AT-A8b	2
	AT-A10	1
	AT-A8	1





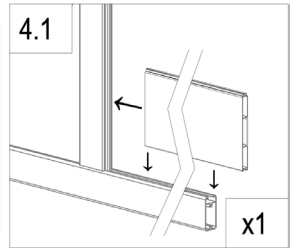
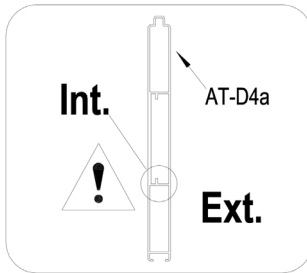
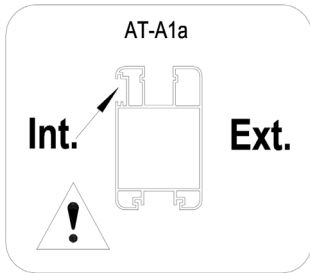
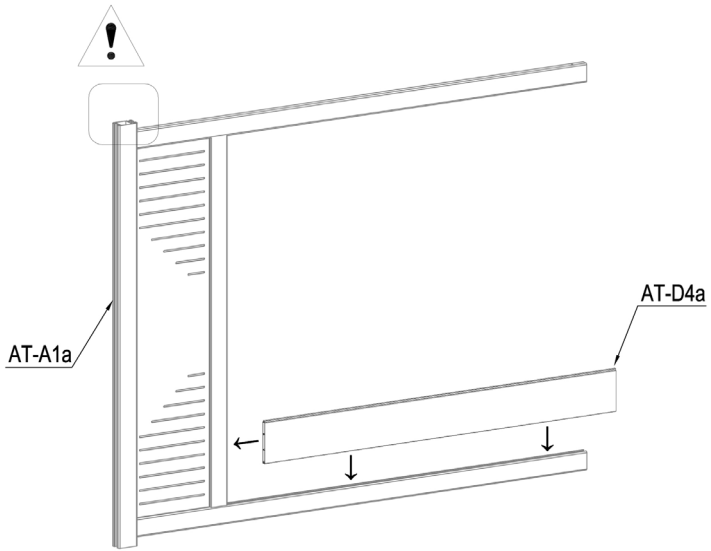

	AT-A1a	1
	Dr-28	2
	AT-L32	4



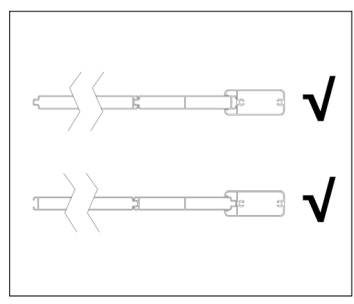
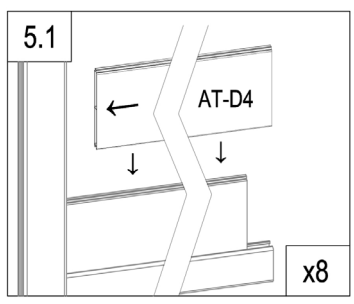
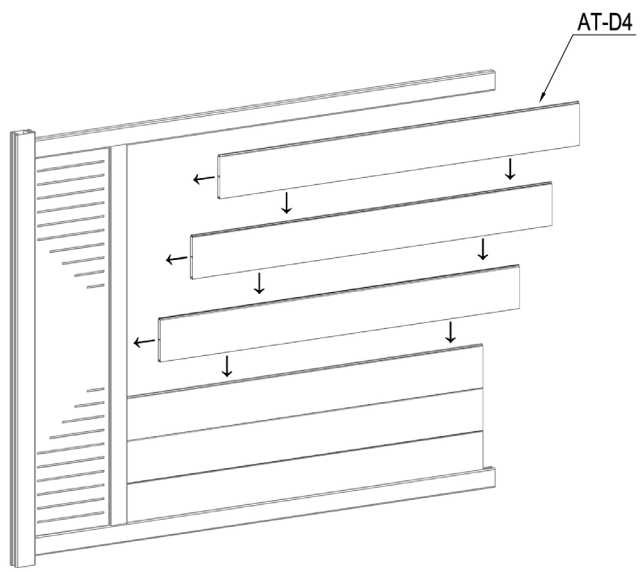

	AT-D4a	1
---	--------	---



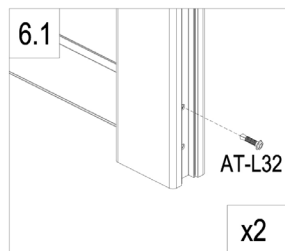
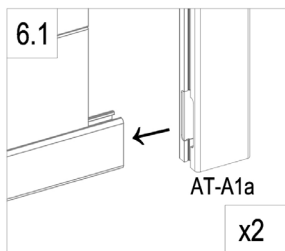
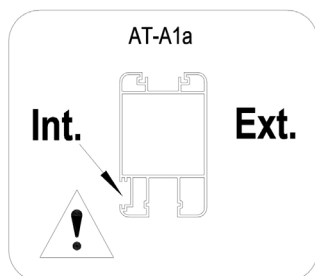
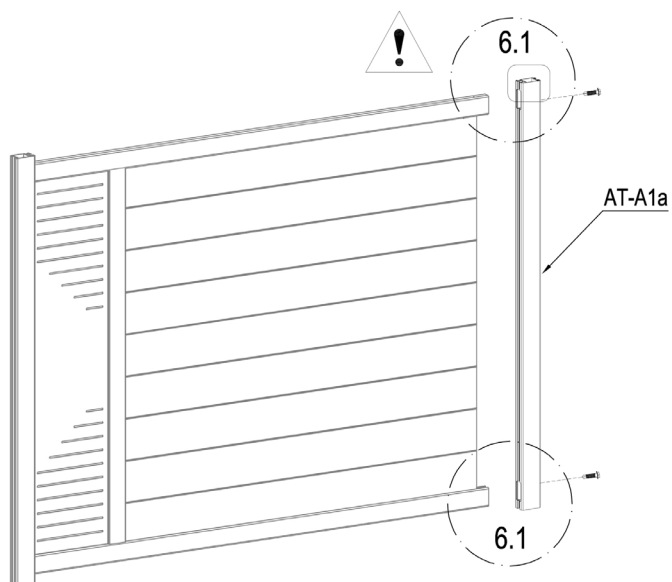

	AT-D4	8
---	-------	---

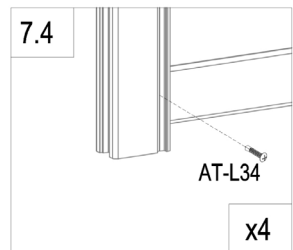
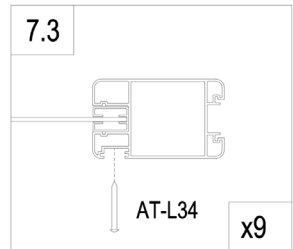
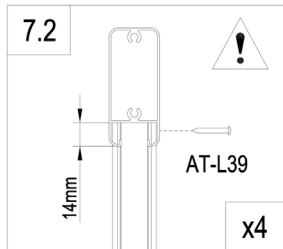
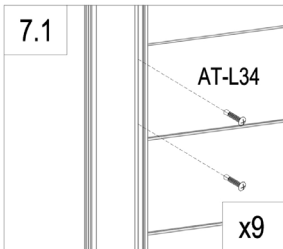
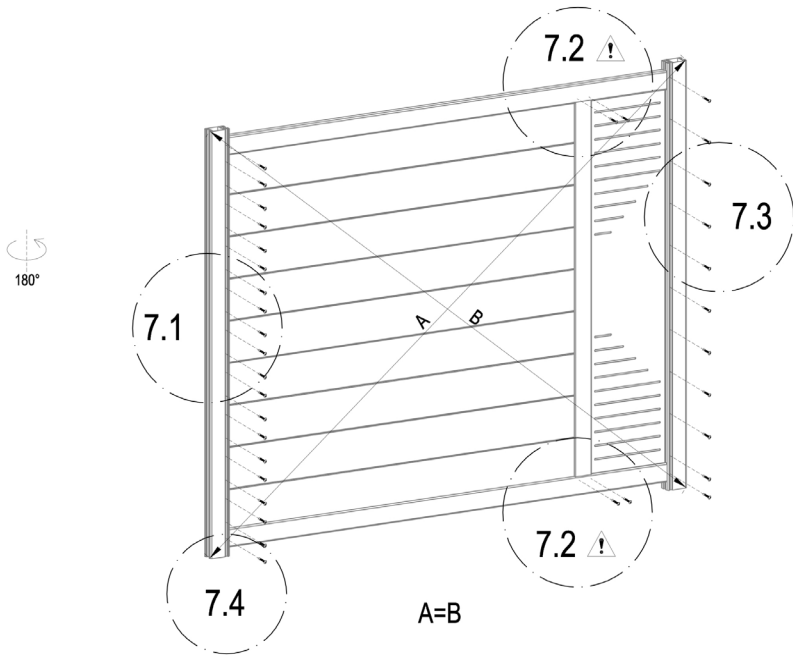

	AT-A1a	1
	AT-L32	2





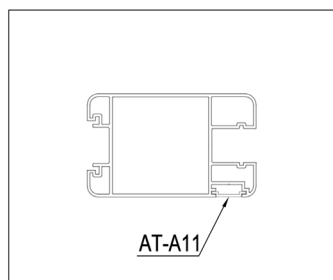
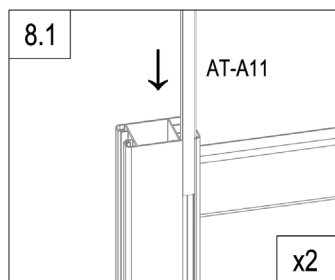
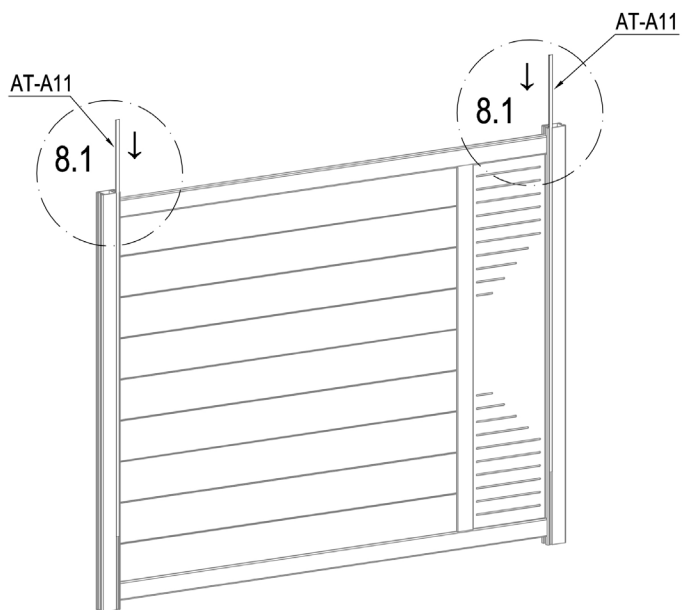

	AT-L34	31
	AT-L39	4

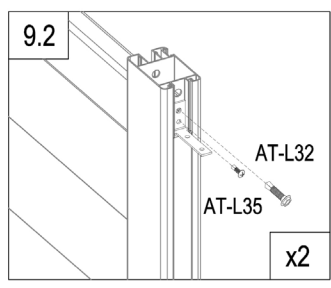
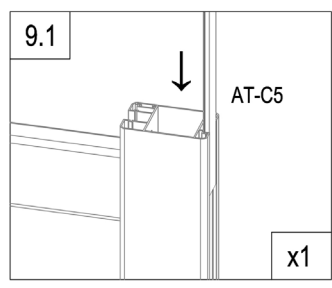
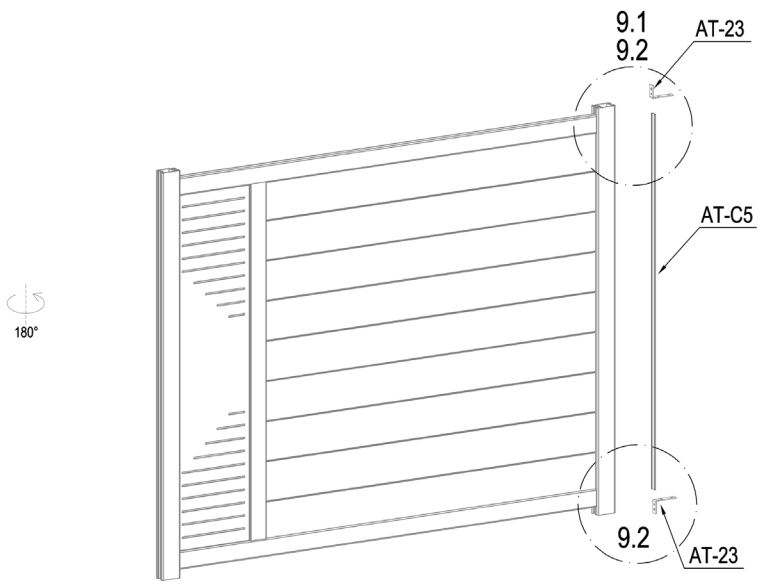





	AT-A11	2
---	--------	---

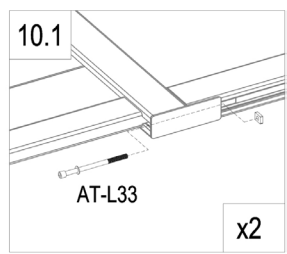
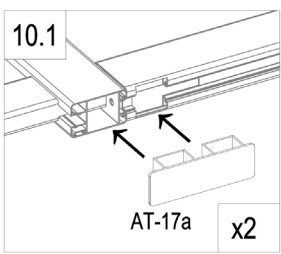
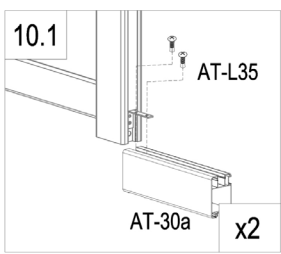
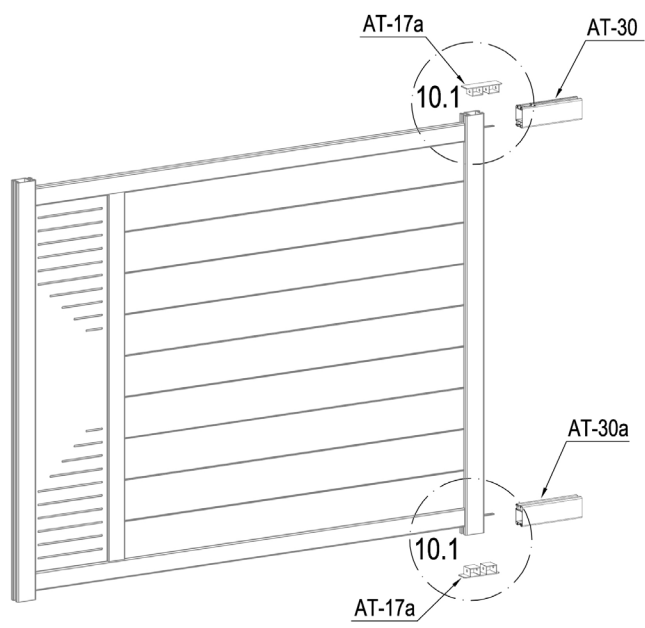





	AT-C5	1
	AT-23	2
	AT-L32	2
	AT-L35	2



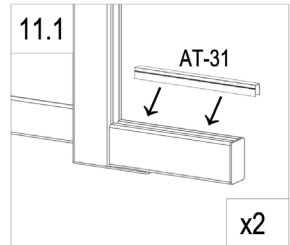
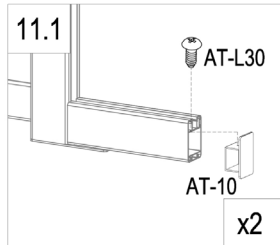
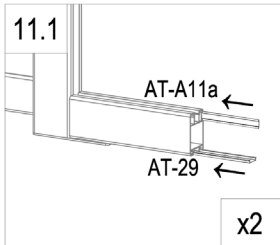
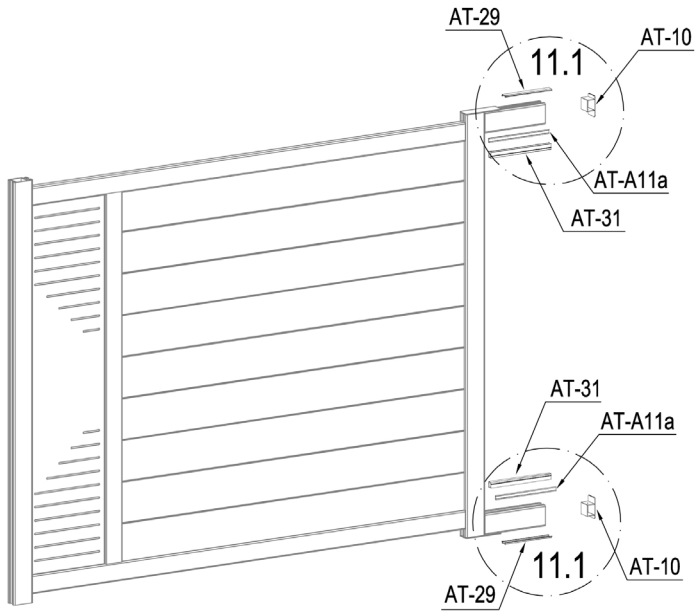

	AT-30	1
	AT-30a	1
	AT-17a	2





	AT-L33	2
	AT-L35	4



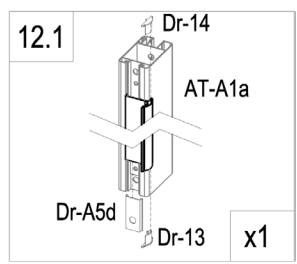
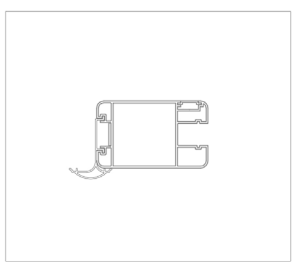
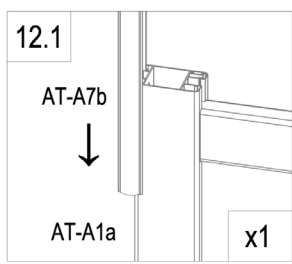
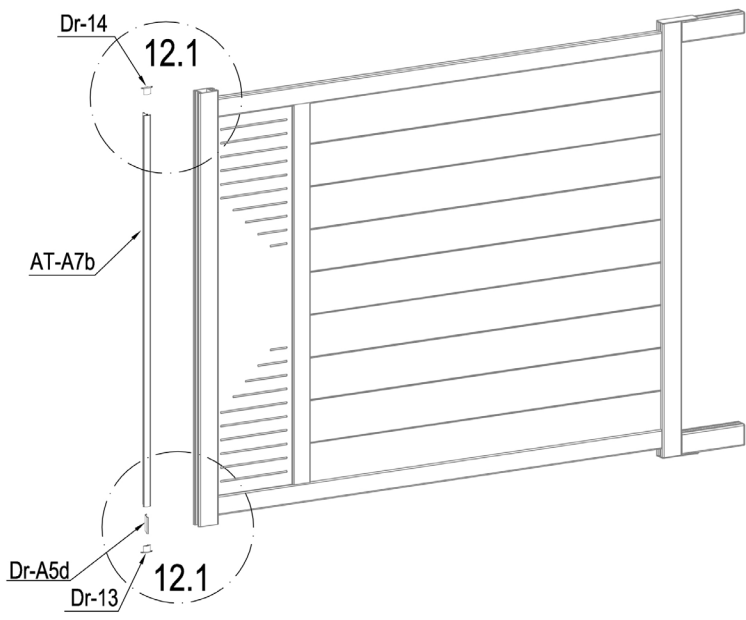

	AT-29	2
	AT-A11a	2
	AT-31	2

	AT-10	2
	AT-L30	2

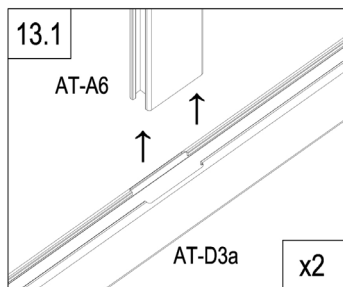
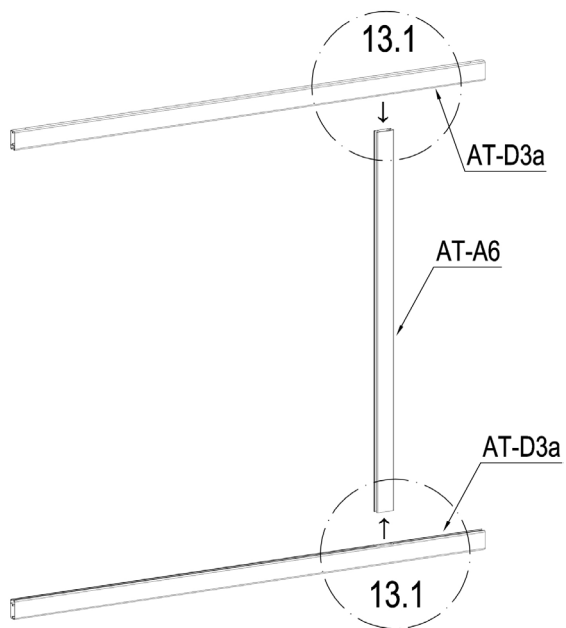

	AT-A7b	1
	Dr-A5d	1
	Dr-13	1
	Dr-14	1



	AT-A6	1
	AT-D3a	2

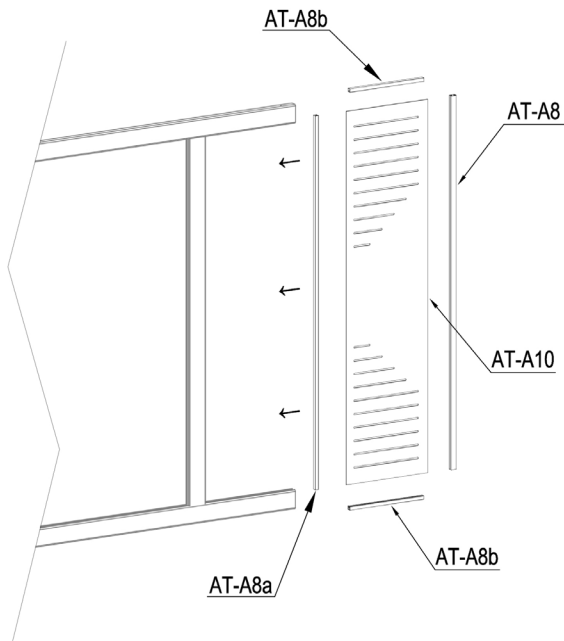



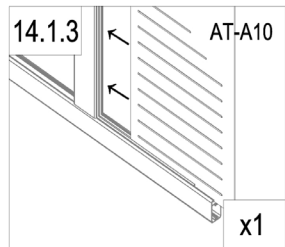
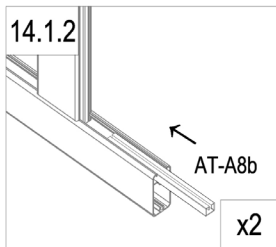
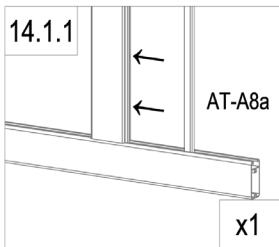

EN :you can flip and switch the direction of this plate to personalize your gate
 FR: vous pouvez retourner et changer la direction de cette plaque pour personnaliser votre portail
 DE: Sie können dieses Schild umdrehen und die Richtung wechseln, um Ihr Tor zu personalisieren.
 ES: puedes girar y cambiar la dirección de esta placa para personalizar tu puerta
 PT: pode virar e mudar a direção desta placa para personalizar o seu portão
 IT: potete capovolgere e cambiare la direzione di questa piastra per personalizzare il vostro cancello
 NL: u kunt de richting van deze plaat omdraaien en veranderen om uw poort te verpersoonlijken...
 PL: można obrócić i przełączyć kierunek tej płyty, aby spersonalizować bramę.

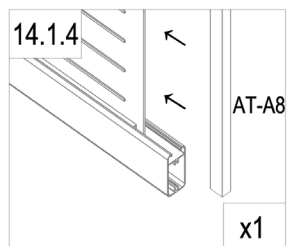

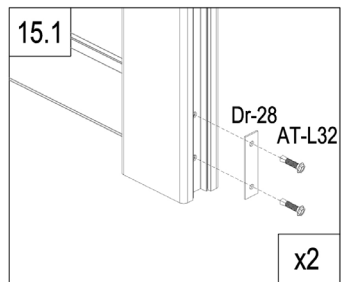
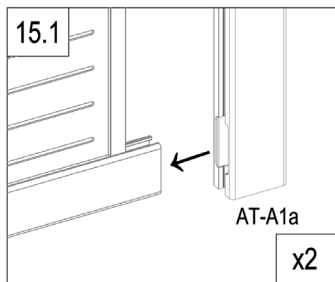
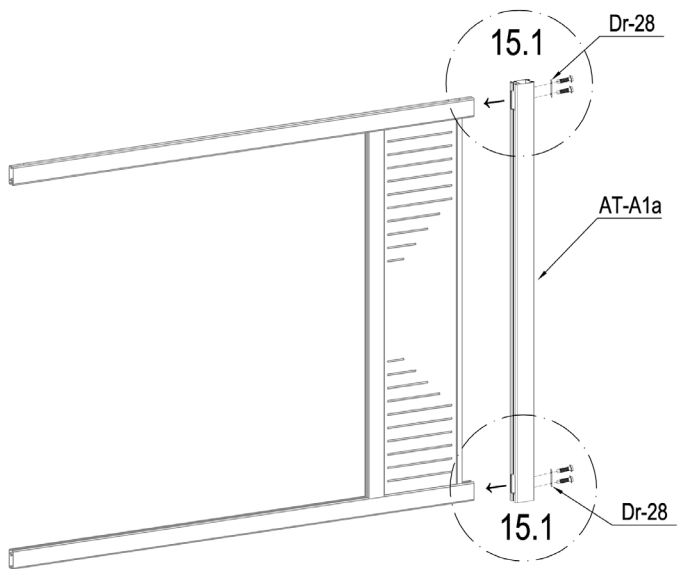
	AT-A8a	1
	AT-A8b	2
	AT-A10	1
	AT-A8	1





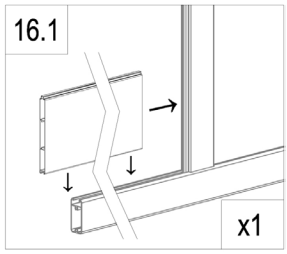
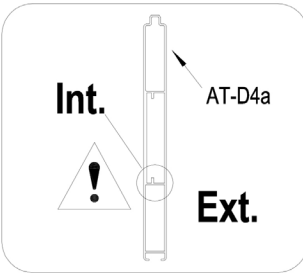
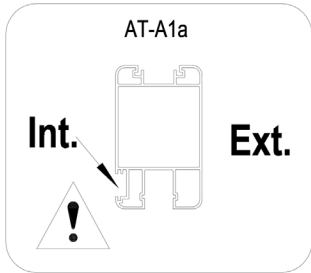
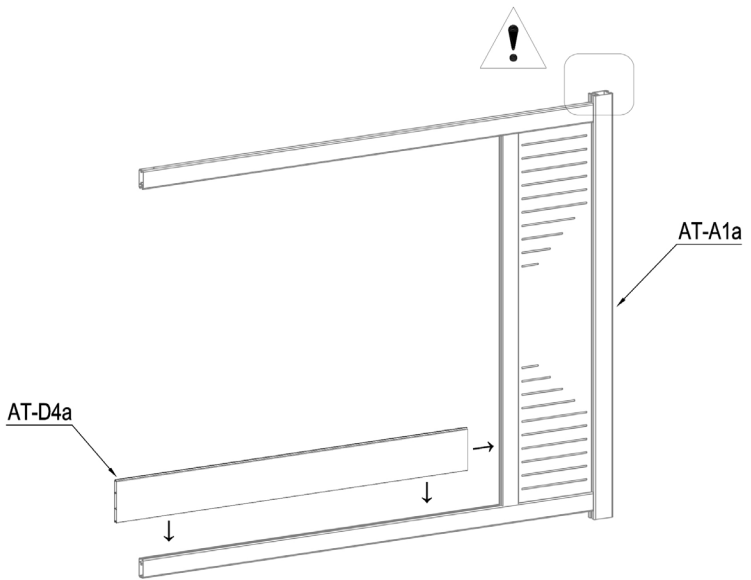

	AT-A1a	1
	Dr-28	2
	AT-L32	4



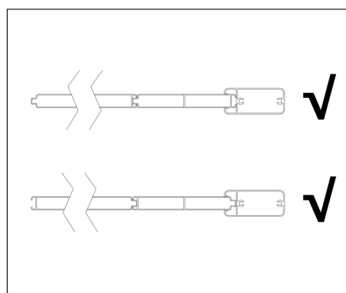
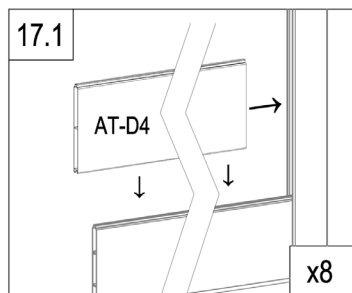
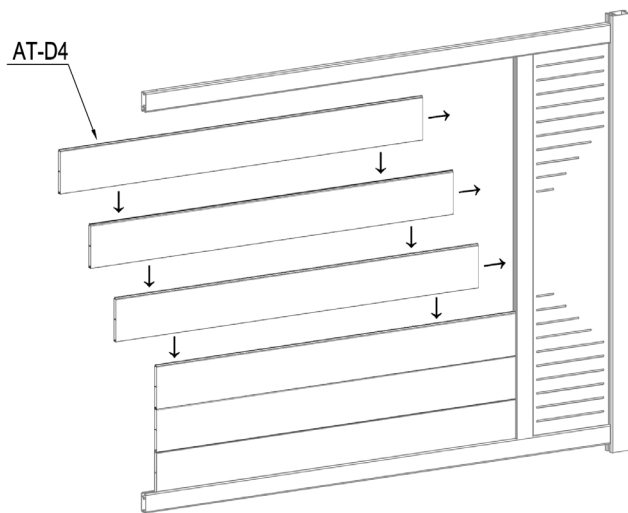

	AT-D4a	1
--	--------	---

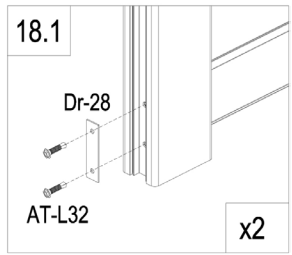
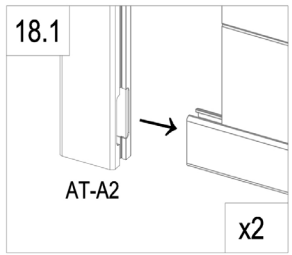
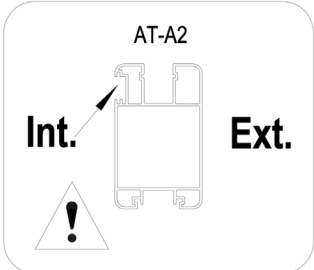
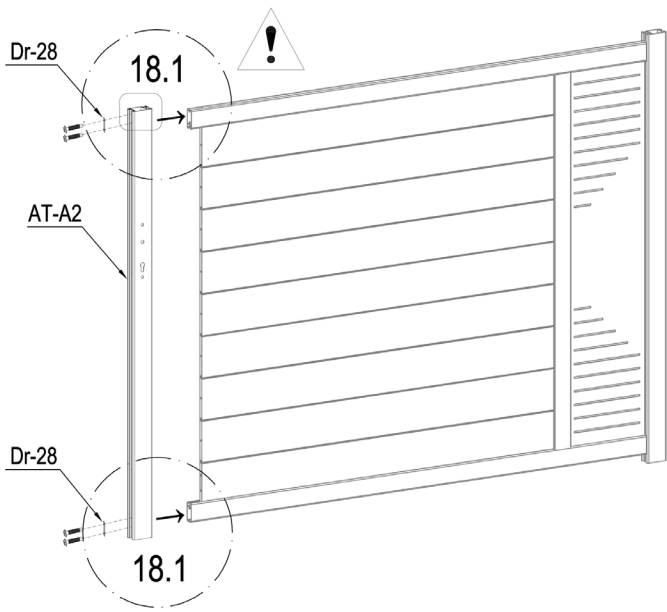

	AT-D4	8
---	-------	---



	AT-A2	1
	Dr-28	2
	AT-L32	4

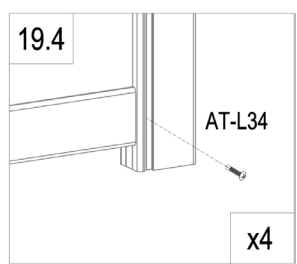
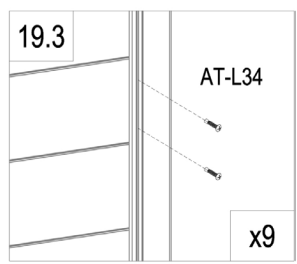
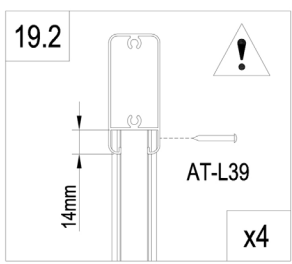
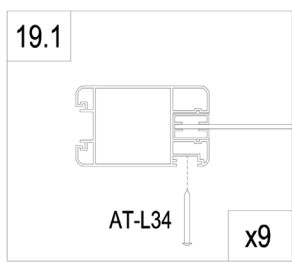
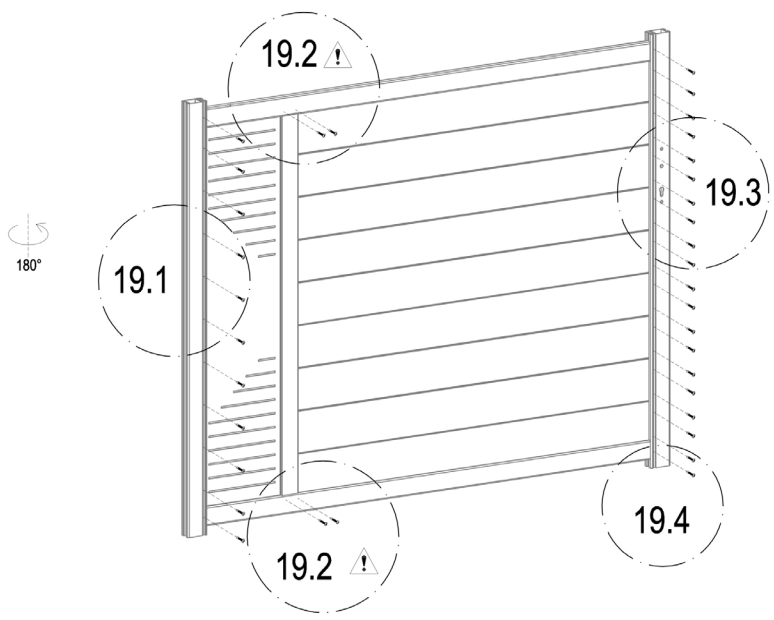

	AT-L34	31
	AT-L39	4

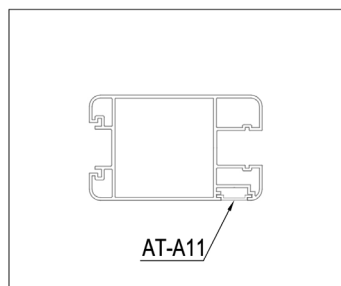
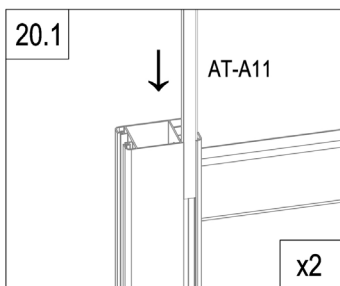
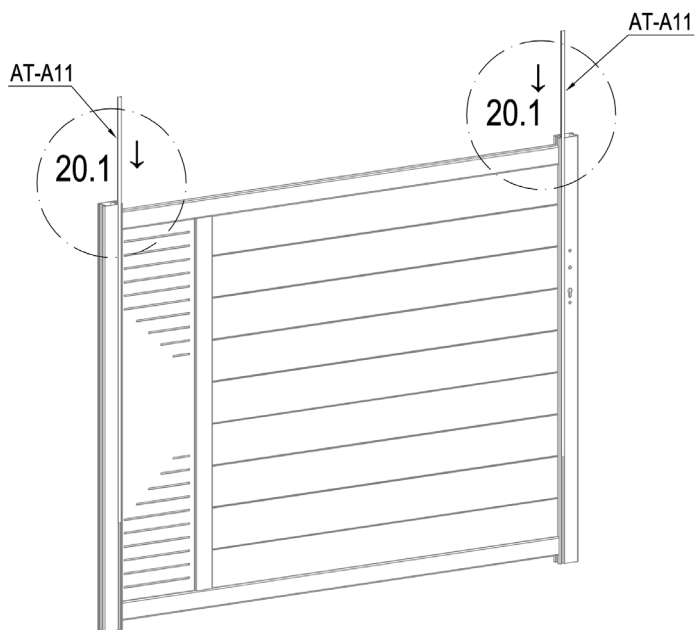

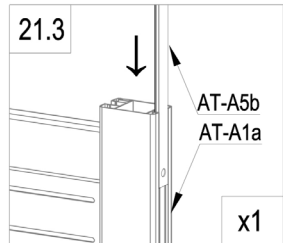
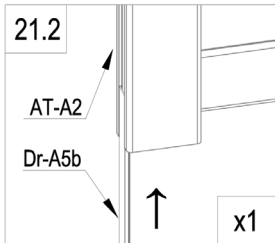
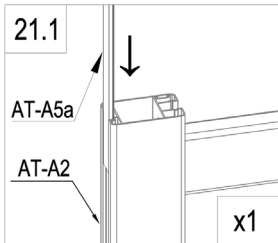
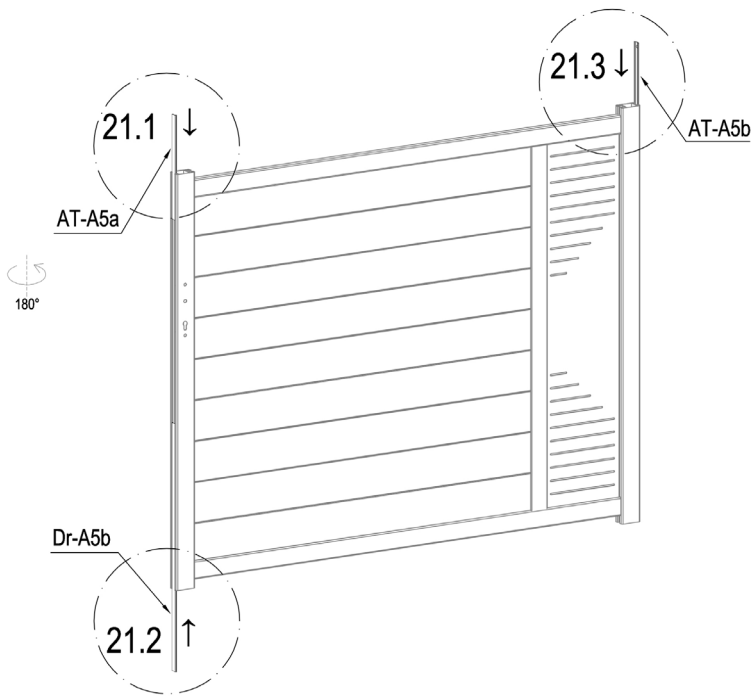

	AT-A11	2
---	--------	---



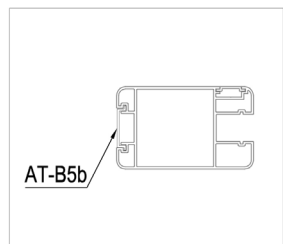

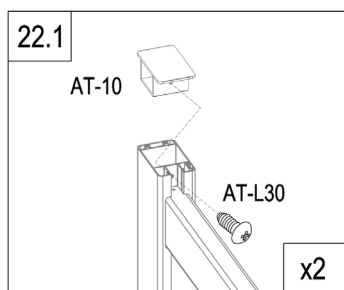
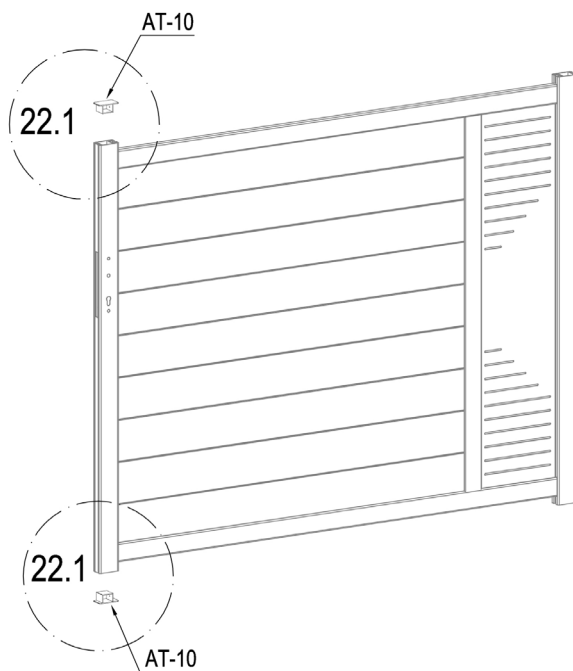
	AT-A5b	1
	AT-A5a	1
	Dr-A5b	1



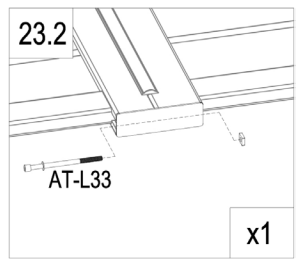
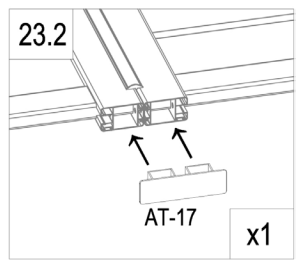
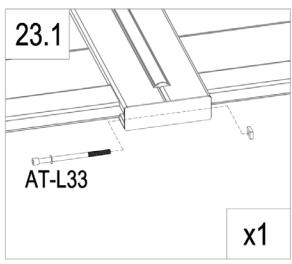
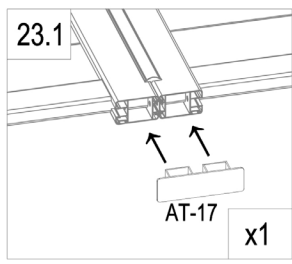
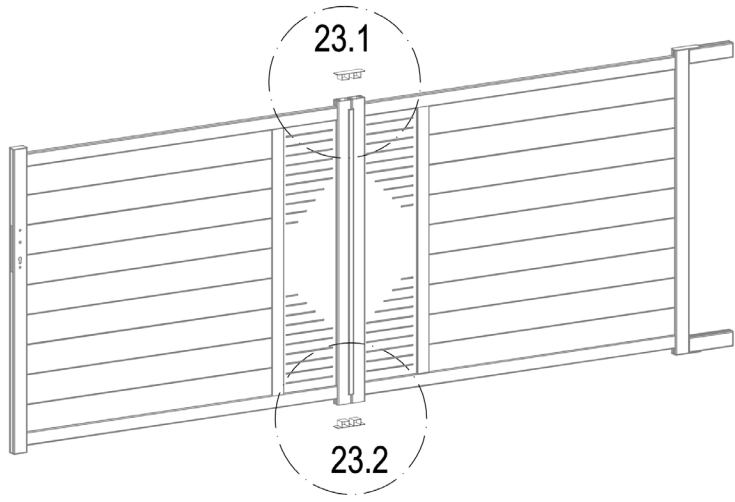

	AT-10	2
	AT-L30	2



	AT-17	2
	AT-L33	2

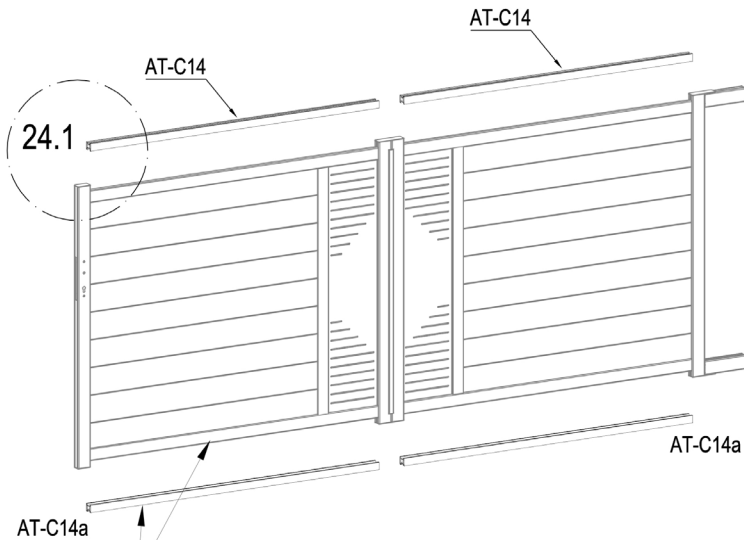

EN: These parts are made for connecting your gate's automation
 FR: Ces pièces sont faites pour relier l'automatisation de votre portail
 DE: Diese Teile sind für den Anschluss der Automatisierung Ihres Tores vorgesehen
 ES: Estas piezas están hechas para conectar la automatización de su puerta
 PT: Estas peças são feitas para ligar a automatização do seu portão
 IT: Queste parti sono realizzate per collegare l'automazione del vostro cancello
 NL: Deze onderdelen zijn gemaakt voor het aansluiten van de automatisering van uw poort.
 PL: Te części są wykonane do podłączenia automatyki bramy.

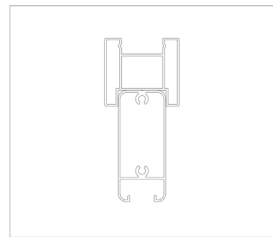
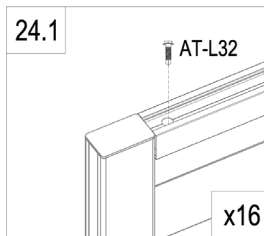
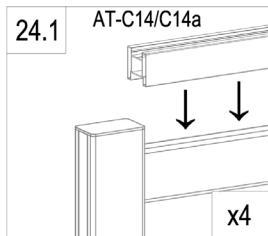

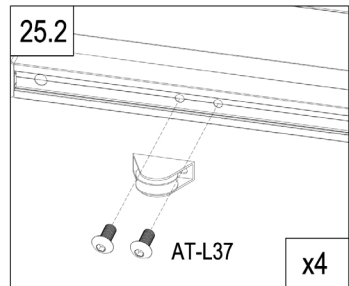
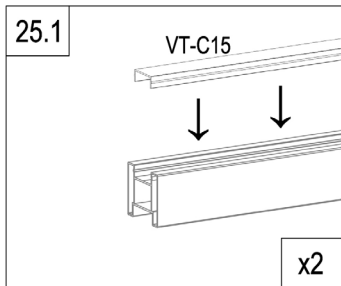
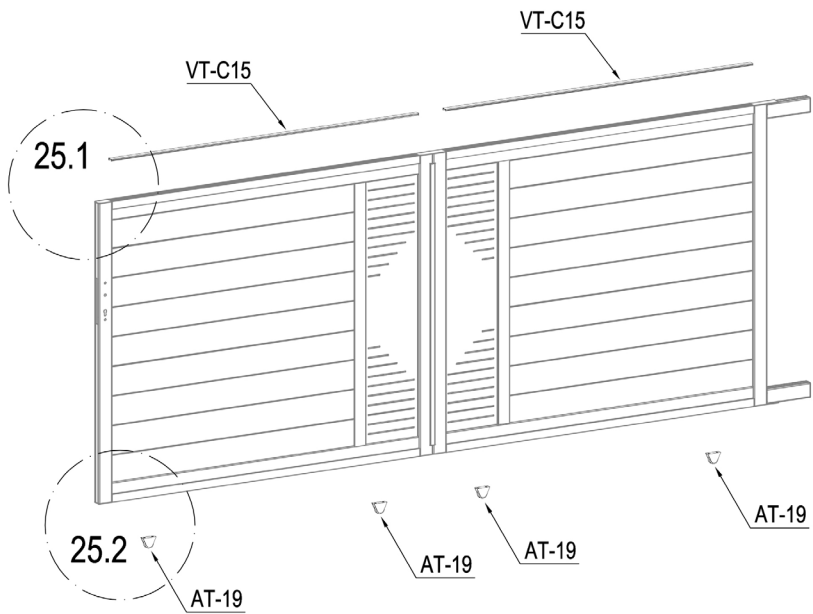

	AT-C14	2
	AT-C14a	2
	AT-L32	16

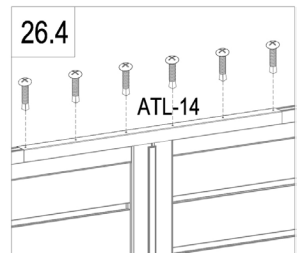
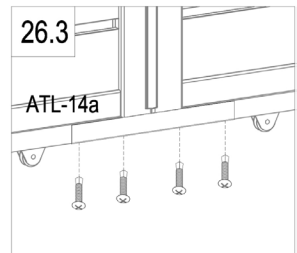
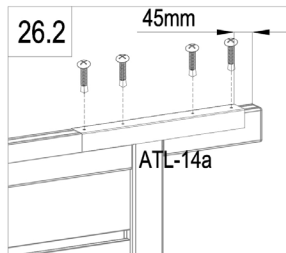
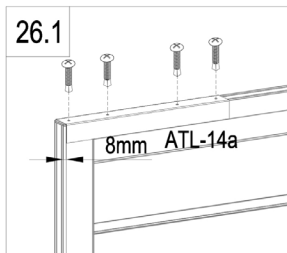
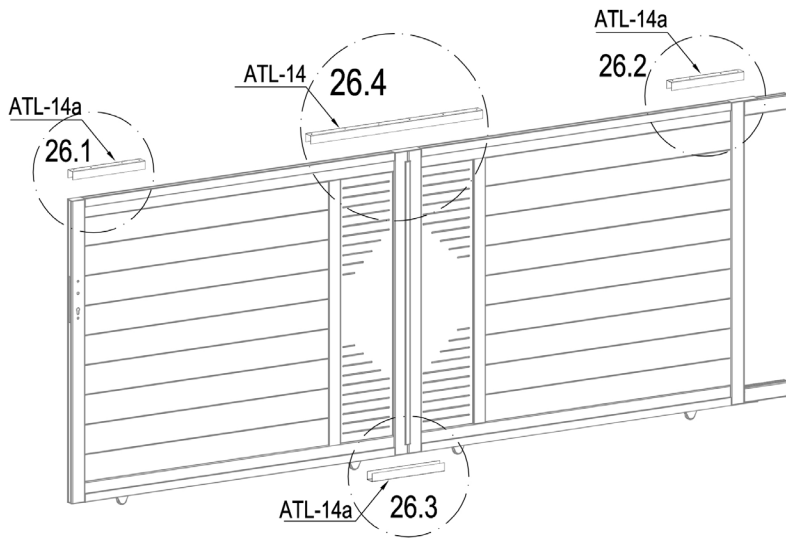

	VT-C15	2
	AT-19	4
	AT-L37	8



	ATL-14	1
	ATL-14a	3
	AT-L34	18

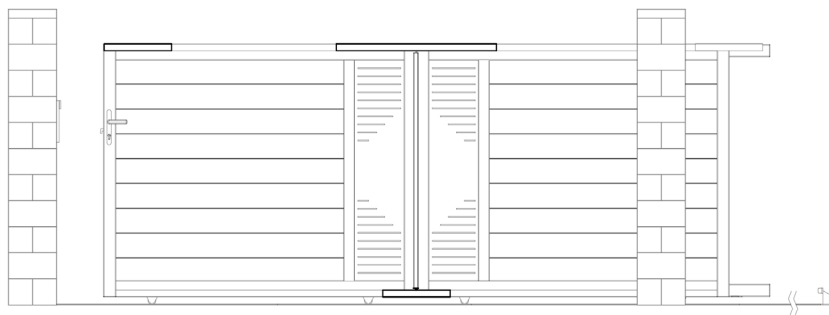

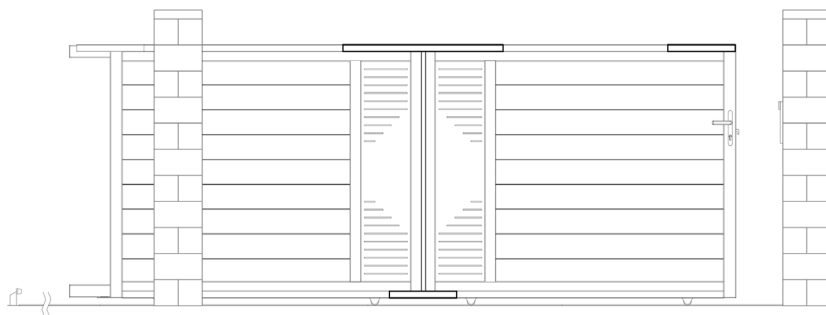

L : P27~32

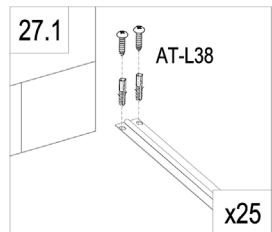
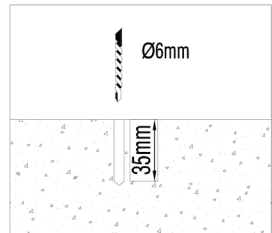
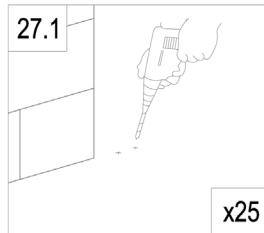
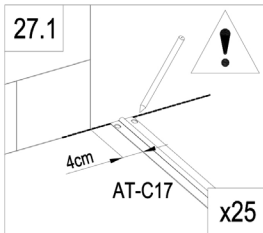
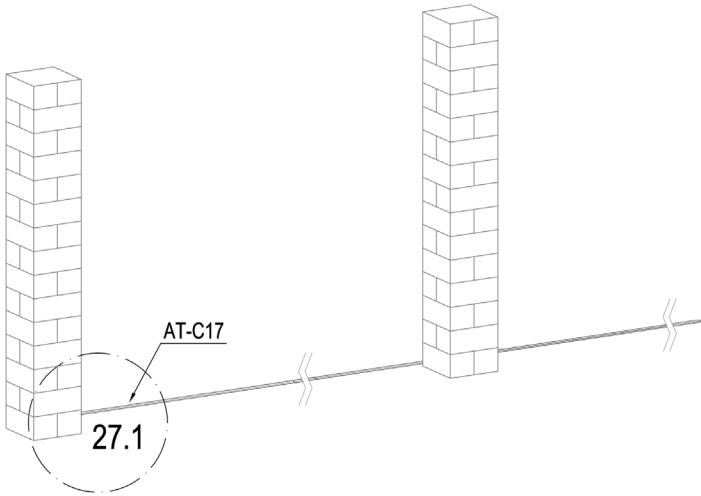

R : P33~38

L



	AT-C17	5
	AT-L38	50

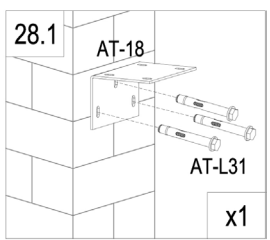
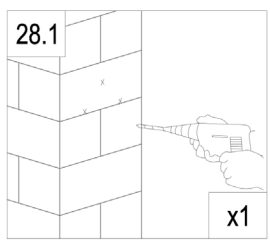
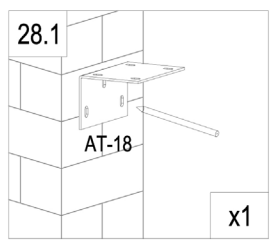
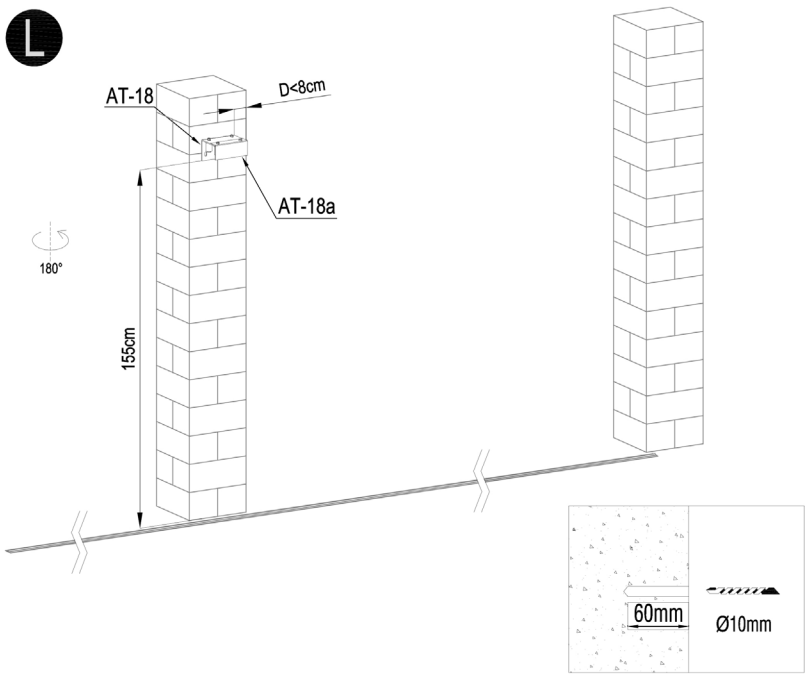

	AT-18	1
	AT-18a	1
	AT-20	4
	AT-L31	3

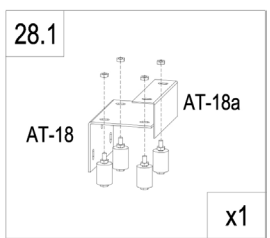
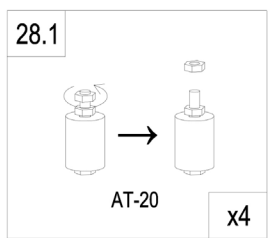

L

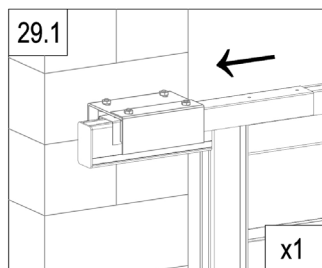
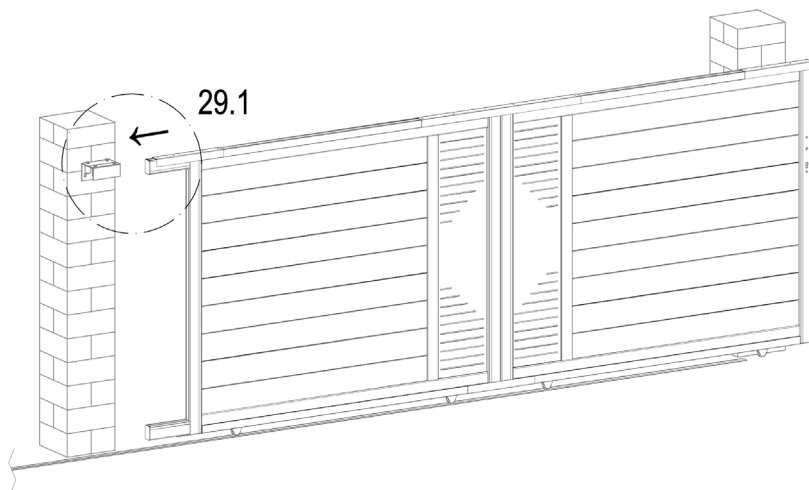

L

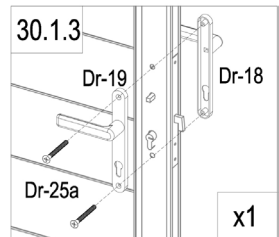
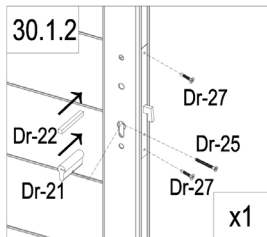
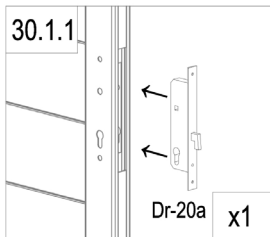
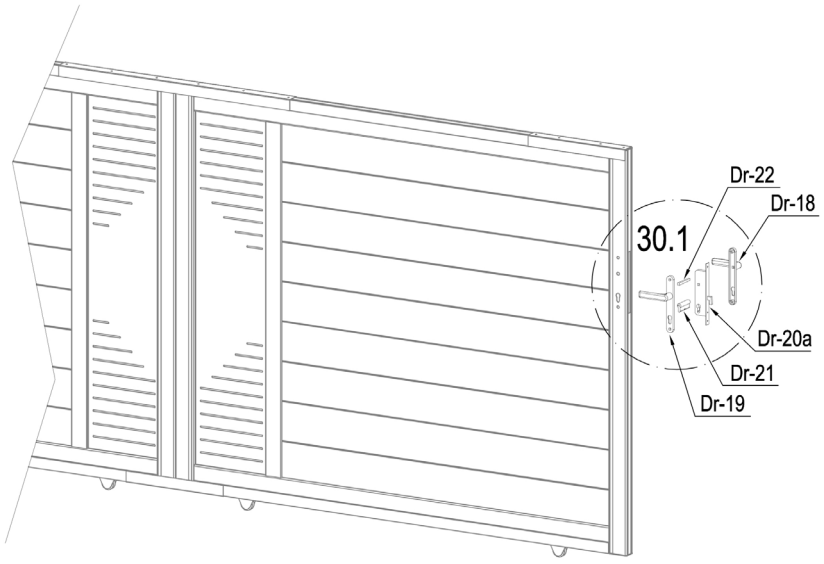

	Dr-20a	1
	Dr-21	1
	Dr-22	1
	Dr-25	1

	Dr-18	1
	Dr-19	1
	Dr-25a	2
	Dr-27	2

L

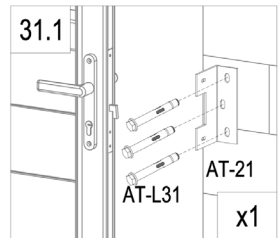
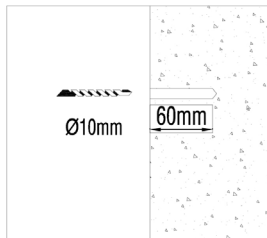
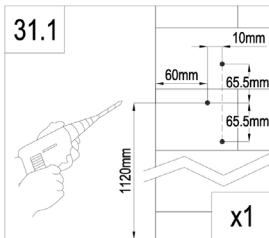
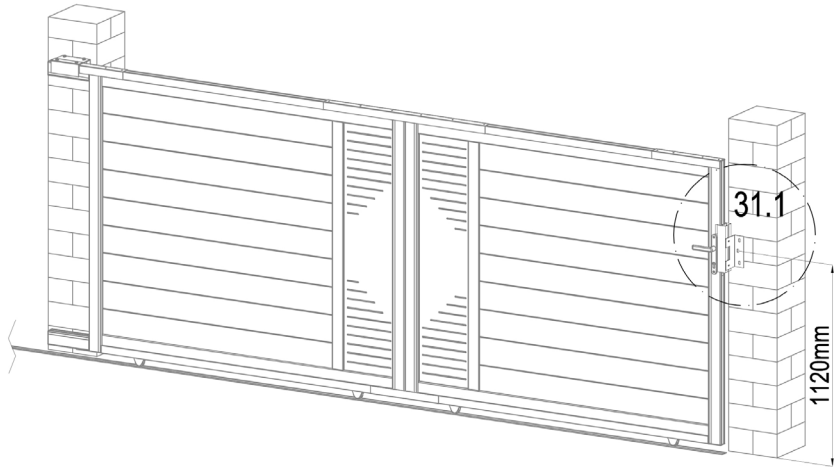

	AT-16	1
	AT-21	1
	AT-L36	2
	AT-L31	3
	AT-22J	3

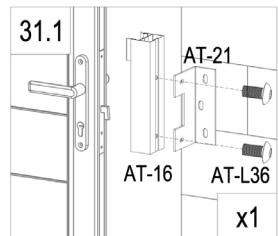
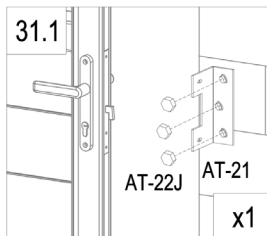

L

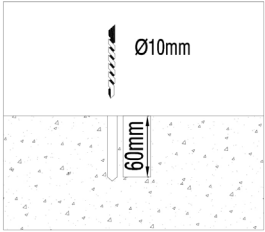
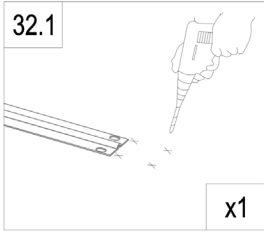
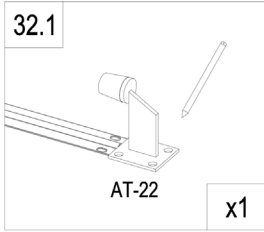
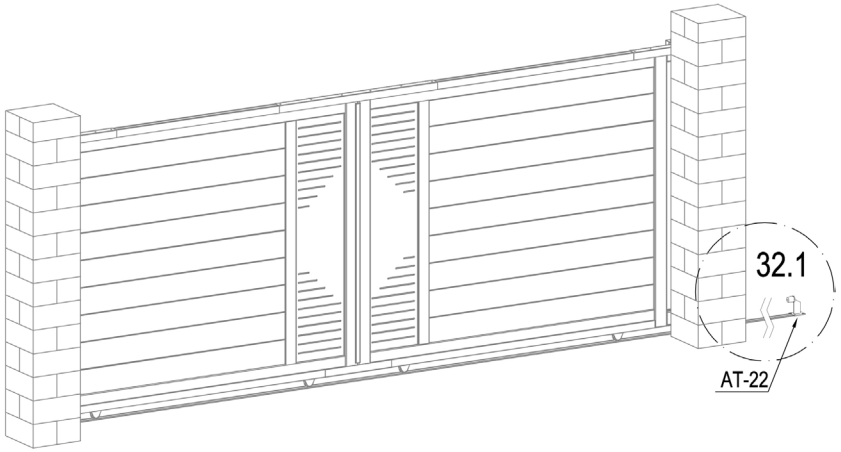

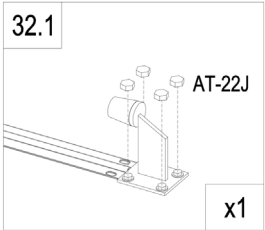
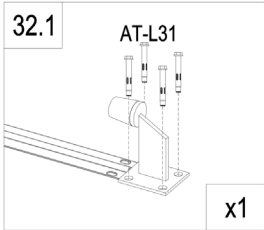

	AT-22	1
	AT-L31	4
	AT-22J	4

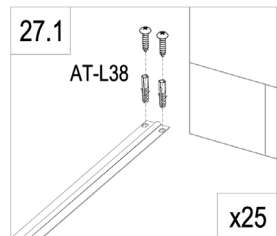
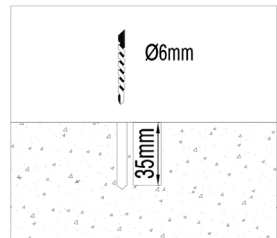
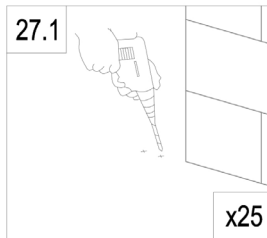
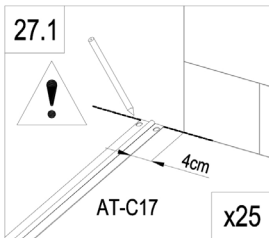
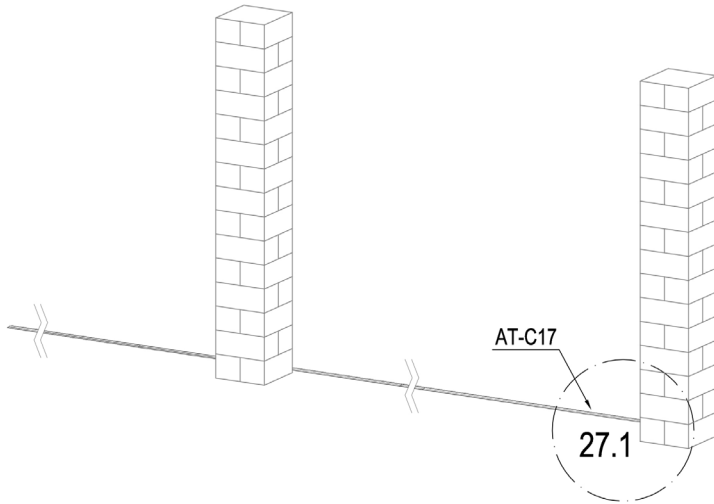

R



	AT-C17	5
	AT-L38	50

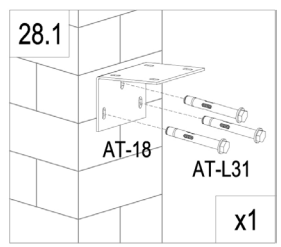
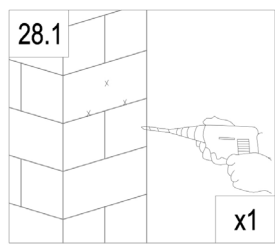
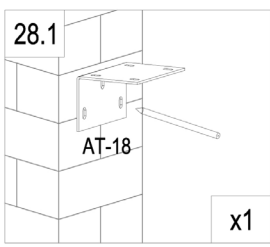
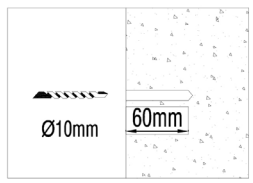
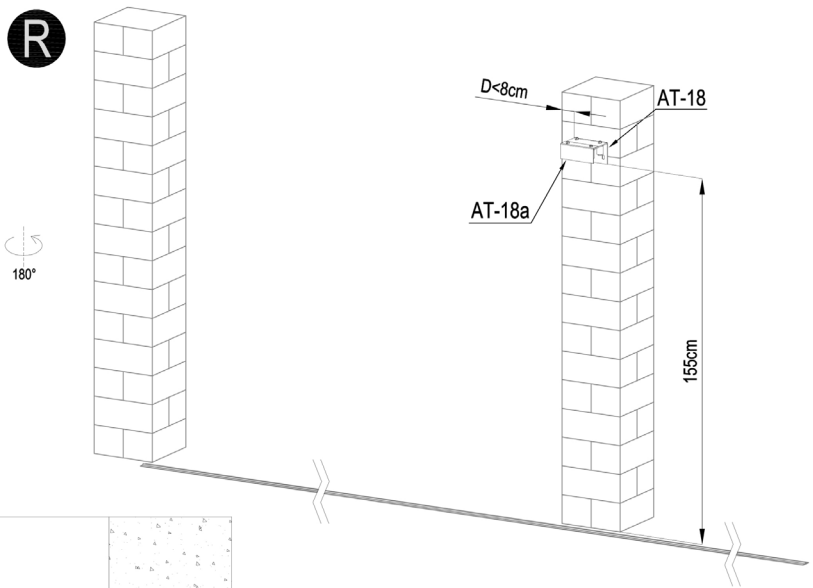

	AT-18	1
	AT-18a	1
	AT-20	4
	AT-L31	3

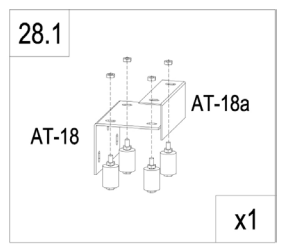
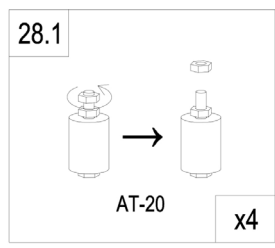

R

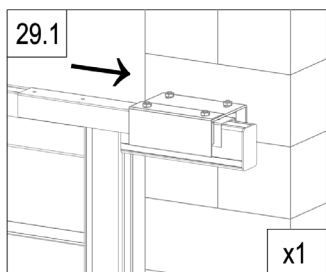
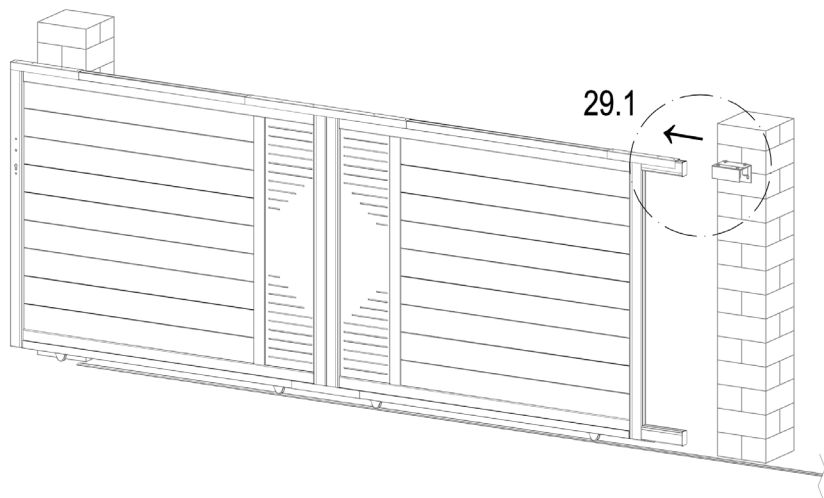

R

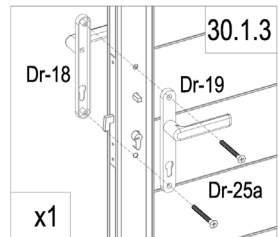
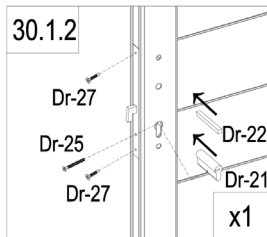
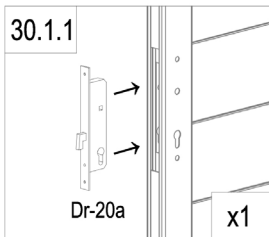
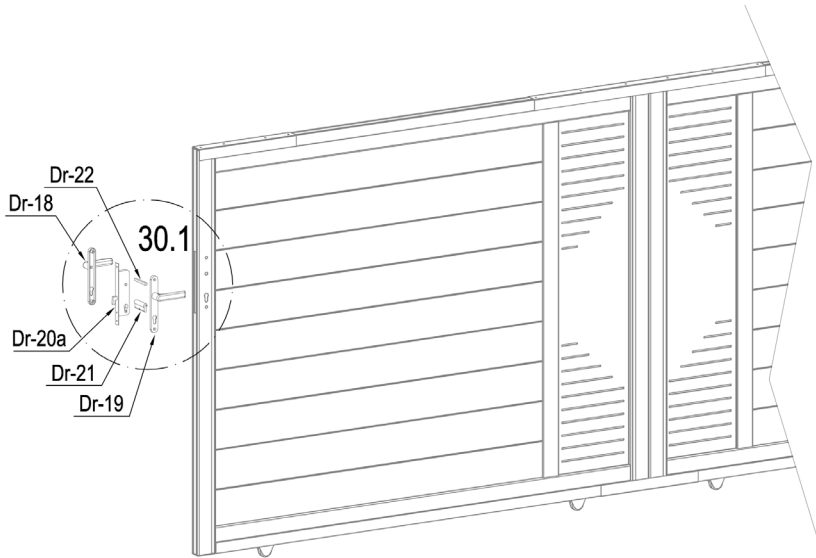

	Dr-20a	1
	Dr-21	1
	Dr-22	1
	Dr-25	1

	Dr-18	1
	Dr-19	1
	Dr-25a	2
	Dr-27	2

R

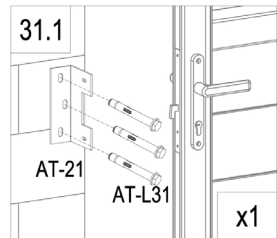
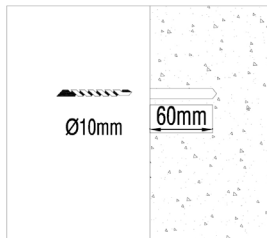
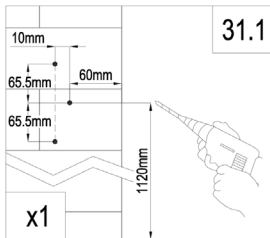
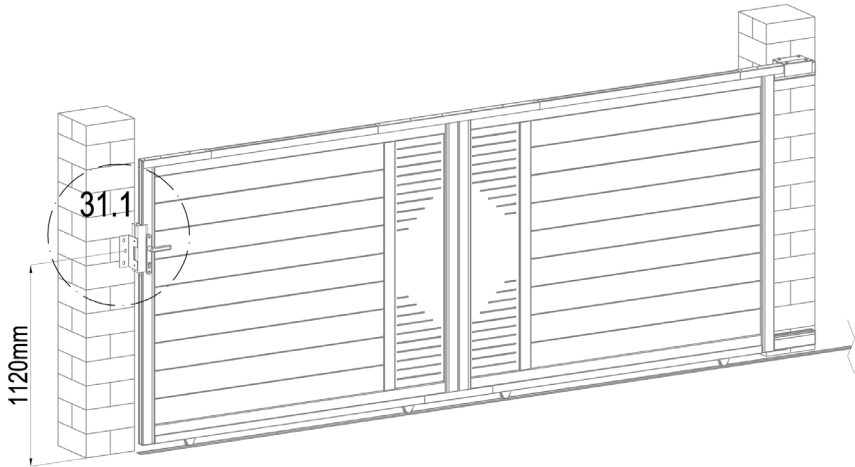

	AT-16	1
	AT-21	1
	AT-L36	2
	AT-L31	3
	AT-22J	3

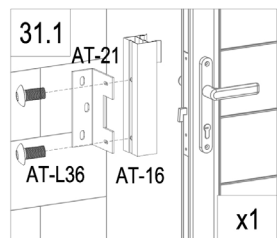
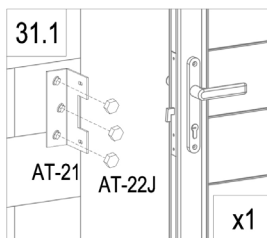

R

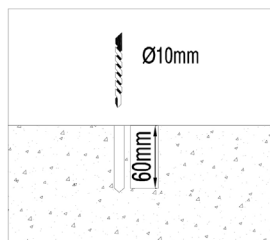
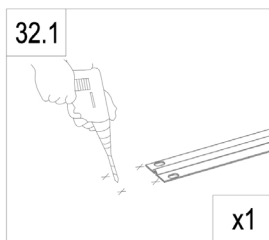
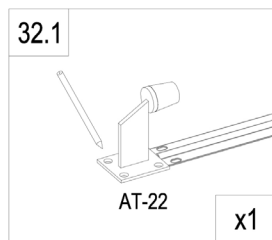
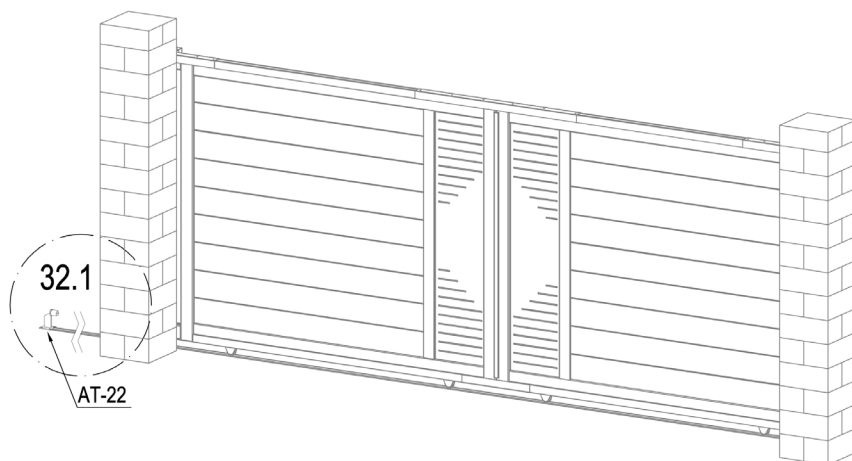

	AT-22	1
	AT-L31	4
	AT-22J	4

