

# BELESSA

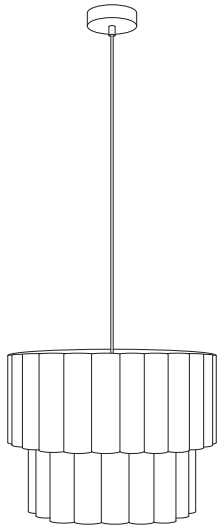

1/6

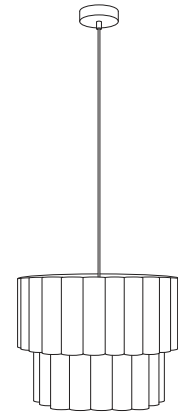

20'

2

2/6

2734/BELESSA/1/80226/

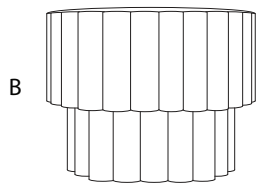
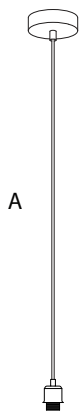

 A x 1	 B x 1	 C x 1	 D x 2	 E x 2
--------------	--------------	--------------	--------------	--------------

3/6

2734/BELESSA/1/80226/

1

A  
 x 1

1a

A

OFF

1b

2

D  
 x 2

E  
 x 2

A

2a

2b

4/6

2734/BELESSA/1/80226/

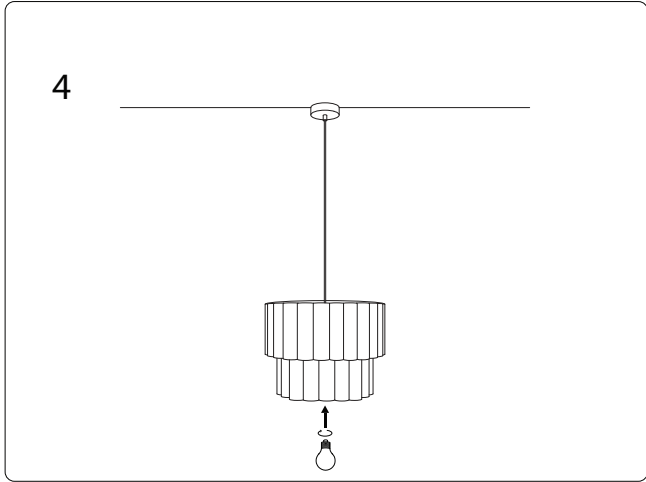
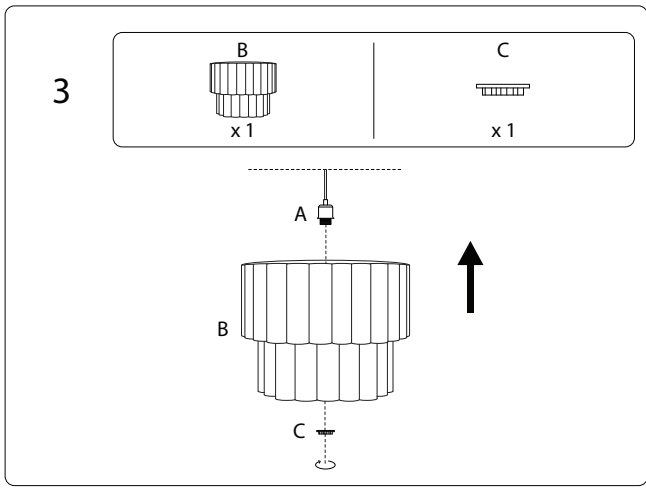

2734/BELESSA/180226/

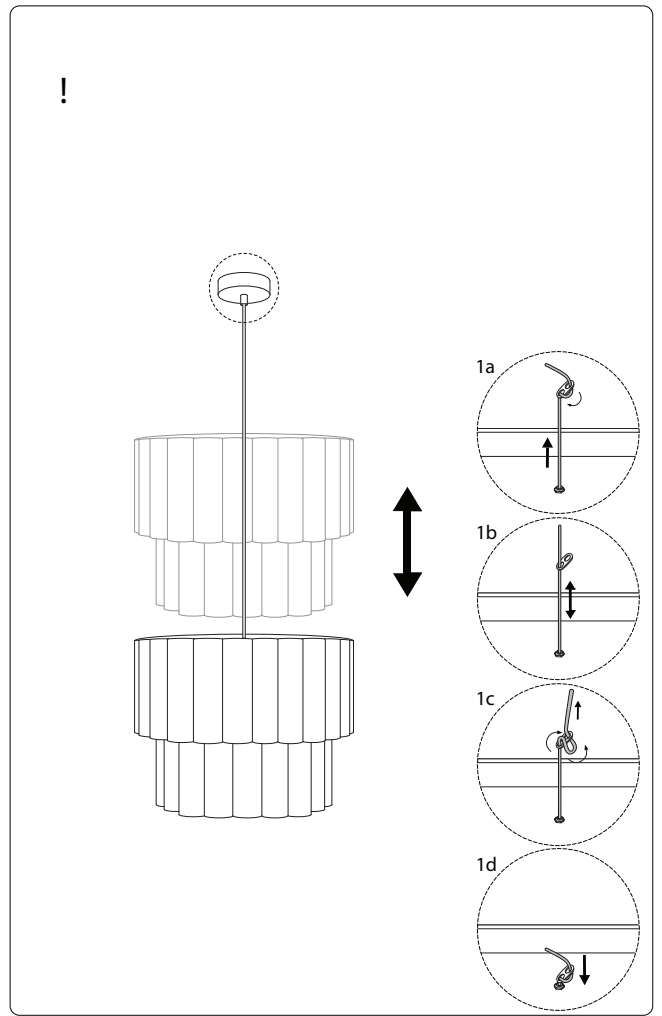

2734/BELESSA/180226/