

# SAM

## 22027

oktaplex  
motion



- |           |                               |           |                         |           |                          |
|-----------|-------------------------------|-----------|-------------------------|-----------|--------------------------|
| <b>DE</b> | - Montageanleitung            | <b>NL</b> | - Montage-instructies   | <b>RO</b> | - Instrucțiuni de montaj |
| <b>FR</b> | - Instructions de montage     | <b>SE</b> | - Monteringsanvisningar | <b>PL</b> | - Instrukcje montażu     |
| <b>ES</b> | - Instrucciones de montaje    | <b>CZ</b> | - Návod k montáži       | <b>GB</b> | - Mounting instructions  |
| <b>IT</b> | - Istruzioni per il montaggio | <b>SK</b> | - Návod na montáž       | <b>PT</b> | - Instruções de montagem |

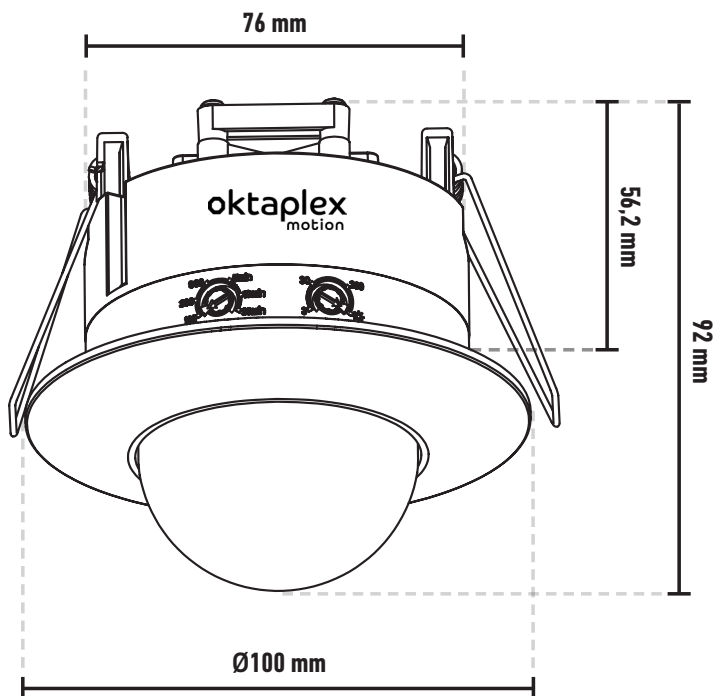

WhatsApp





# SAM

Präsenzmelder für Innen und Außen / Détecteur de présence pour l'intérieur et l'extérieur / Detector de presencia para interior y exterior / Rilevatore di presenza per interni ed esterni / Aanwezigheidsmelder voor binnen en buiten / Närvarodetektor för inomhus- och utomhusbruk / Detektor přítomnosti pro interiér i exteriér / Detektor přítomnosti pre interiér a exteriér / Detectoare de prezență pentru interior și exterior / Czujnik obecności do zastosowań wewnętrznych i zewnętrznych / Presence detector for indoors and outdoors / Detetor de prezença para interiores e exteriores

Nennspannung / Tension nominale / Tensión nominal / Tensione nominale / Nominaal voltage / Märkspänning / Jmenovité napětí / Menovité napätie / Tensiunea nominală / Napięcie nominalne / rated voltage / tensão nominal

AC 220-240 V  
50-60Hz

Nennleistung / Puissance nominale / Potencia nominal / Potenza nominale / Nominaal vermogen / Märkeffekt / Jmenovitý výkon / Menovitý výkon / Putere nominală / Moc znamionowa / rated power / potência nominal

0,5 W

Maximale Leistungsaufnahme / Consommation électrique maximale / Consumo máximo de energía / Massimo consumo di energia / Maximaal stroomverbruik / Maximal strömförbrukning / Maximální spotřeba energie / Maximálna spotreba energie / Consum maxim de energie / Maksymalne zużycie energii / Maximum power consumption / Consumo máximo de energia

 2000W

 1000W

Schutzklasse / Indice de protection / Clase de protección / Classe di protezione/ Beschermingsklasse / Skyddsklass / Třída ochrany / Trieda ochrany / Clasa de protecție / Klasa ochrony / Protection class / Classe de protecção

II

Schutzart / Indice de protection IP / grado de protección / Livello di protezione IP / IP mate van bescherming / IP-klass / Stupeň ochrany / Stupeň IP ochrany / Clasa de protecție IP / Klasa ochrony IP / Protection class / Classe de protecção

IP20

Umgebungstemperatur / Température ambiante / Temperatura ambiente / Temperatura ambiente / Omgevingstemperatuur / Omgivningstemperatur / Okolní teplota / Okolită teplota / Temperatura ambiantă / Temperatura otoczenia / Ambient temperature / Temperatura ambiente

-20°C - +40°C

# INSTALLATION



1

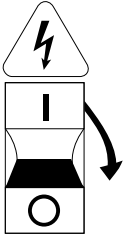

2

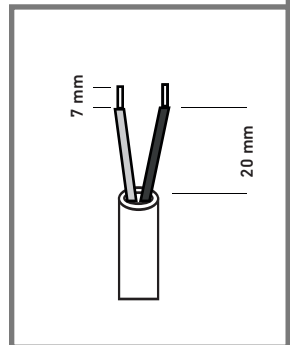
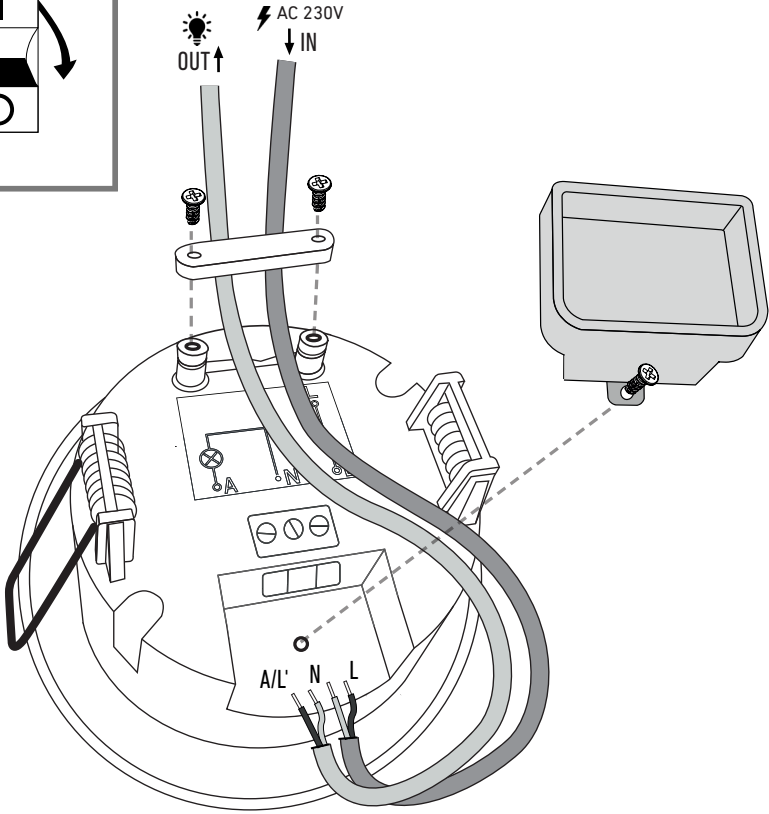

# INSTALLATION

3

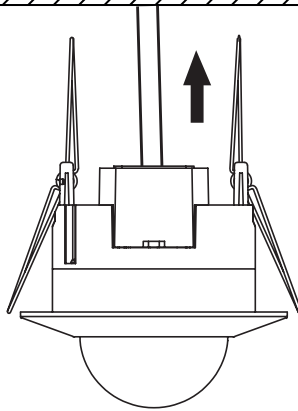
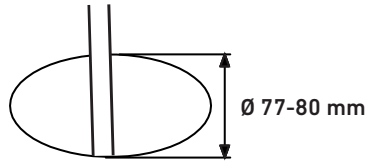

4

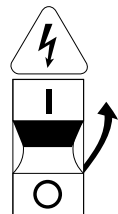

# INSTALLATION

## Master-Slave

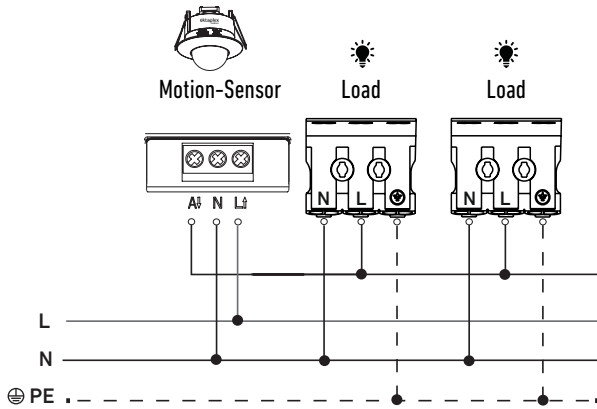

**i** max. Load  
2000W   
1000W

## Master-Master

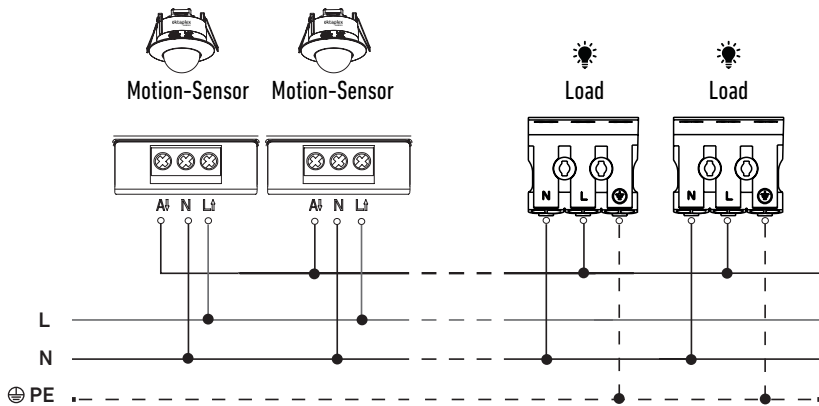

# SETTINGS

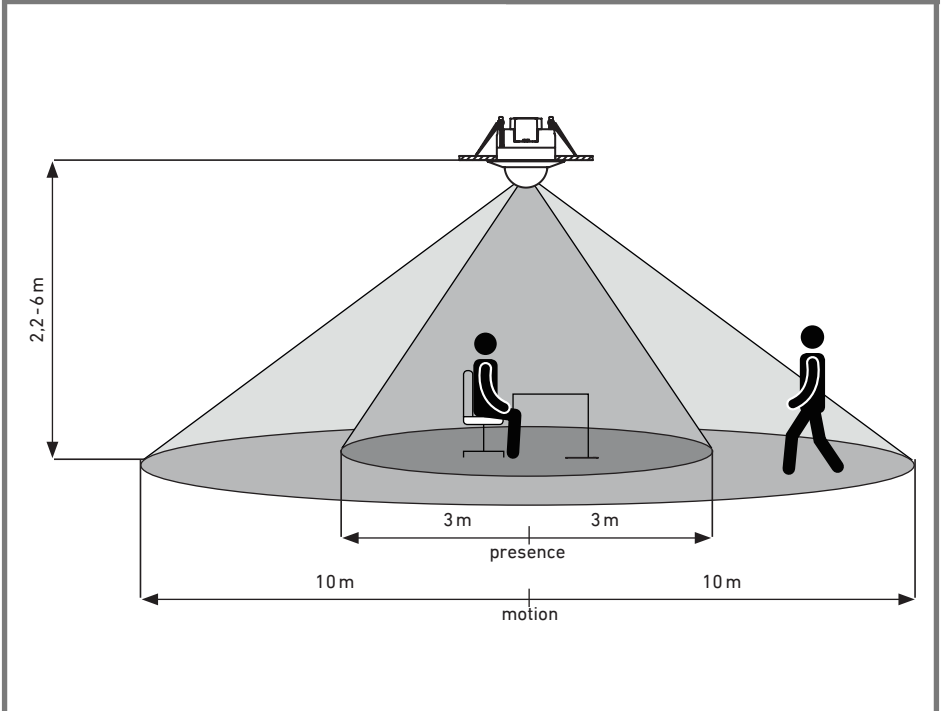
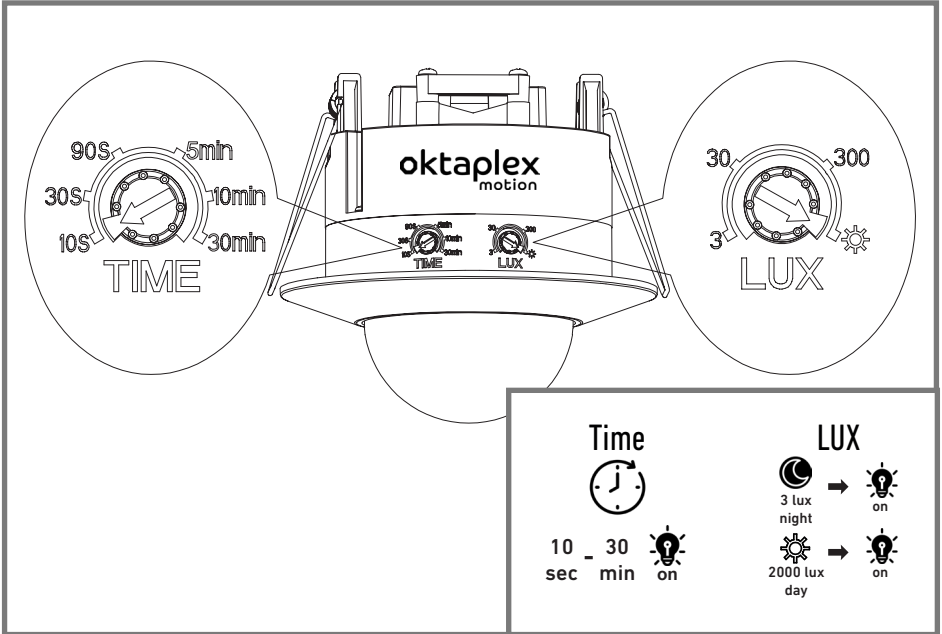



Points de collecte sur [www.quefairedemesdechets.fr](http://www.quefairedemesdechets.fr)

ETAPLEX GmbH · Höherweg 245 · 40231 Düsseldorf · Germany  
+49 211 9726 4070 · [info@etaplex.de](mailto:info@etaplex.de) · [oktaplex.de](http://oktaplex.de)